

PRICELIST 2026

A Legacy of
Trusted Partnerships

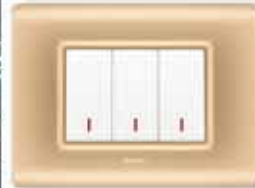



Power

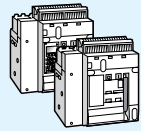

P. 23-26
DMX³ ACB from 630 A to 6300 A manual & electrical fixed + drawout version

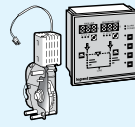

P. 28-29
Auxiliaries & accessories

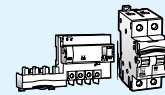

P. 32
E-communicating infrastructure

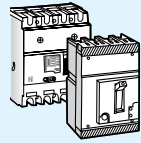

P. 48-67
DPX³ MCCBs & accessories

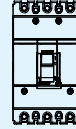

P. 70
DRX 125 MCCBs



P. 71-75 DRX 125, 250^{HP} & 630 MCCBs & accessories

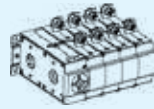

P. 82-83
DSX



P. 86-88
EMDX³ Digital meter

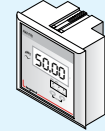

P. 90-92
PMX Digital panel meter

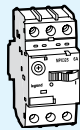

P. 102-105
MPX³ & MPX³ accessories



P. 107
Alpx³ box type capacitors standard and heavy duty 440 V

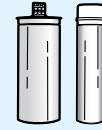

P. 107
ALPX³ resin filled capacitors standard and heavy duty 440 V, 480 V & 525 V



Protection, Isolation, Controlling, Signalling, Metering.

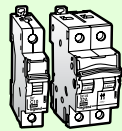

P. 112-114
DX³ MCB & isolators

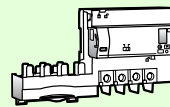

P. 116-118
DX³ RCD add-on module with metering



P. 119-120
DX³ time switches and contactors

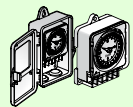

P. 119
Time switches and accessories



Distribution Boards

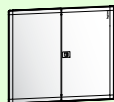

P. 132
Ekinox³ SPN DB

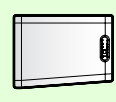

P. 132
Ekinox³ ETPN & Flexy DBs



P. 133
Ekinox³ TPN-VTPN DBs Phase selector neo DB



P. 136-137
Ekinox³ metal enclosures

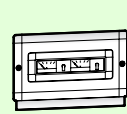

P. 137
Ekinox³ Cable end box, meter box, PPT Kit & accessories



P. 137
Ekinox³ DBs Plexo 3, boxes for DX³ and accessories



Arteor™ Advance



NEW!
P. 154-156
Push Buttons, Electric Roller Blinds, Dimmers and Fan Regulators, Indian Standard Sockets, Energy Plugs, USB Chargers, Data and Voice, TV Sockets



NEW!
P. 156-157
Classic Matt White Mechanisms, Infrared Sensors, Skirting Light, Hospitality Functions, Protector and Accessories, Audio- Video Sockets



NEW!
P. 162-163
Classic Matt Titanium Mechanisms, Hospitality Functions, Protector and Accessories, Audio- Video Sockets



NEW!
P. 163-165
Elite Matt White Mechanisms, Push Buttons, Electric Roller Blinds, Dimmers and Fan Regulators, Temperature Room Control Unit, USB Chargers, Hospitality FunctionsLight, Hospitality Functions, Protector and Accessories, Audio- Video Sockets

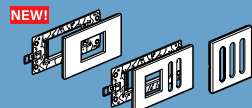

NEW!
P. 167-170
Classic Cover Plate with support frame, Elite Cover Plate with support frame, Hybrid (Classic + Elite) Cover Plate with support frame

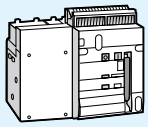

P. 34-36
DMX SP 2500 ACB
630 A to 2500 A fixed
version draw-out
version

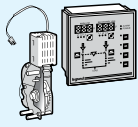

P. 37
Auxillaries &
accessories



P. 37
DMX SP 2500
protection units

NEW!

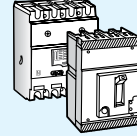

P. 42-47
DPX³ MCCBs -
125/160/250 HP

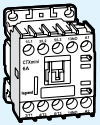

P. 94-96
CTX³ contactors

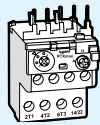

P. 97-98
RTX³
thermal relays

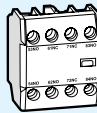

P. 99-101
CTX³ accessories



P. 107
Alpican gas filled
capacitors
heavy duty 440 V



P. 108
Reactors and power
factor controllers

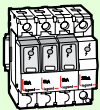

P. 123-125
SPD

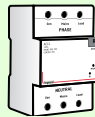

P. 127
ACCL

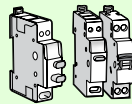

P. 127
DX3 changeover switches,
push buttons and indicators



P. 133
Ekinox³
TPN DB
7/8 segment DB



P. 134
Ekinox³
Mivan SPN,
ETPN
DB PPI DB



P. 136
Ekinox³
Phase selector Neo DB



P. 136
Ekinox³
P17 Tempra plug &
socket DBs

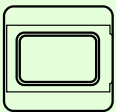

P. 138
Plexo DBs
and accessories

NEW!

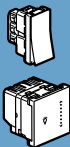

P. 157-159
Classic Matt Black Mechanisms, Push
Buttons, Electric Roller Blinds, Dimmers
and Fan Regulators, Indian Standard
Sockets, Energy Plugs, USB Chargers,
Data and Voice, TV Sockets, Skirting Lights

NEW!

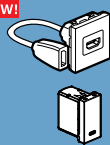

P. 159-160
Classic Matt Black
Mechanisms, Hospitality
Functions, Protector
and Accessories, Audio-
Video Sockets

NEW!



P. 160-162
Classic Matt Titanium Mechanisms,
Push Buttons, Electric Roller Blinds,
Dimmers and Fan Regulators, Indian
Standard Sockets, Energy Plugs, USB
Chargers, Data and Voice, TV Sockets

NEW!



P.165
Elite Matt Black Mechanisms, Push
Buttons, Electric Roller Blinds, Dimmers
and Fan Regulators, Temperature Room
Control Unit, USB Chargers, Hospitality
Functions

NEW!



P. 165-166
Elite Matt Titanium Mechanisms,
Push Buttons, Electric Roller Blinds,
Dimmers and Fan Regulators,
Temperature Room Control Unit,
USB Chargers, Hospitality Functions

NEW!



P.170-171
Accessories, Metal Plush Boxes &
Plastic Surface Boxes



Arteor™
Advance
IoT



NEW!

P. 180-181

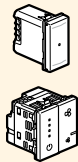

Classic Matt White & Matt Titanium Mechanism - Connected Light Switches, Outlets, Step Fan Controller, Gateway Pack, Wireless Control, Wireless Scenario Switches, IN Wall & Batteryless Switches

NEW!

P. 181-182

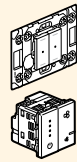

Classic Matt Black Mechanism - Connected Light Switches, Outlets, Step Fan Controller, Gateway Pack, Wireless Control, Wireless Scenario Switches, IN Wall and Batteryless Switches

NEW!

P. 185-186



Matt White, Matt Titanium, Matt Black, Frosted White and Black, Brushed Stainless Steel, Solid Aluminium and Midnight Blue Classic Cover Plates with support frame

NEW!

P. 187



Frosted White and Black, Brushed Stainless Steel, Solid Aluminium and Midnight Blue Elite Cover Plates with support frame



Arteor™

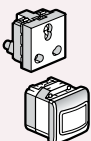

P. 202

Square white mechanism

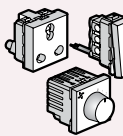

P. 202-203

Square white mechanism, USB chargers, data & voice, hotel functions, energy plugs, USB charger, RJ 11 telephone sockets, information outlets

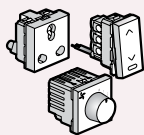

P. 206-208

Square champagne mechanism, USB chargers, data & voice, hotel functions, audio video, energy plugs, USB charger, RJ 11 telephone sockets, information outlets

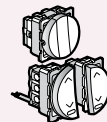

P. 208

Round white mechanisms



Arteor™
IoT



P. 224

Arteor™
connected home

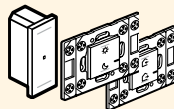

P. 224-225

White, magnesium & champagne mechanism-connected light switches, outlets, gateway pack, wireless controls & wireless scene switches



Myrius™

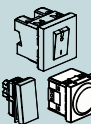

P. 234

Classic white switches, push buttons, dimmers & regulators, emergency light, sockets



P. 235-236

Hospitality functions, sockets, electronic function, USB chargers



P. 238-240

Plate with frame
White, ice white, ice black, pearl champagne, sonic silver, dark fade, interlude, trinity, luminar, stellar, ice silk, ice graphite, white glass & black glass

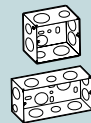

P. 240

Metal flush boxes



Myrius™
IoT



P. 244-245

Connected home white & charcoal grey mechanism, light switches, connected outlets, curtain/roller binder, gateway pack, wireless control, wireless scene switches, regulator



NEW!

P. 182

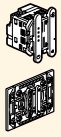

Elite Matt White Mechanism - Connected Light Switches, Outlets, Step Fan Controller, Gateway Pack, Wireless Control, Wireless Scenario Switches, IN Wall and Batteryless Switches

NEW!

P. 183



Elite Matt Titanium Mechanism - Connected Light Switches, Outlets, Step Fan Controller, Gateway Pack, Wireless Control, Wireless Scenario Switches, IN Wall and Batteryless Switches

NEW!

P. 183-184

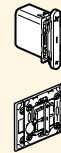

Elite Matt Black Mechanism - Connected Light Switches, Outlets, Step Fan Controller, Gateway Pack, Wireless Control, Wireless Scenario Switches, IN Wall and Batteryless Switches

NEW!

P. 188-189



Frosted Black, Brushed Stainless Steel, Solid Aluminium and Midnight Blue Hybrid (Classic +Elite) Cover Plates with support frame

NEW!

P. 189



Accessories, Metal Flush Boxes

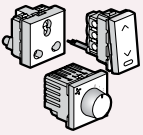

P. 204
Square magnesium mechanism, audio video

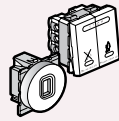

P. 204-206

Square magnesium mechanism USB chargers, data & voice, hotel functions, audio video, energy plugs, USB charger, RJ 11 telephone sockets, information outlets

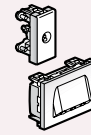

P. 206
Square champagne mechanism



P.208-210
Round magnesium+champagne mechanism switches, push buttons, dimmers & regulators, plates,accessories

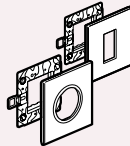

P. 211-218

Square cover plates, round cover plates

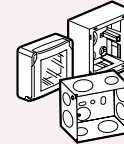

P. 218-219
Plastic surface, metal flush boxes, plexo boxes & accessories



P. 225-229
Cover plates with and without frame & accessories

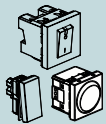

P. 236
Charcoal grey mechanisms, switches, push buttons, dimmers & regulators, emergency light, sockets



P. 237-238

Charcoal grey mechanisms, hospitality functions, electronic function, usb chagers



P. 238
Mechanism antibacterial & accessories



P. 241
Plastic surface boxes & metal surface boxes



P. 245-248
Cover frame
White, ice white, ice black, pearl champagne, sonic silver, dark fade, interlude, trinity, luminar, stellar, ice silk, ice graphite, white glass & black glass



P. 248-249
Cover plates without frame & accessories





**Myrius™
Regular**

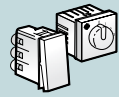

P. 250
White mechanism switches, push buttons, sockets, power units and dimmer and regulators

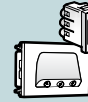

P. 251
Hospitality functions, sockets, electronic function

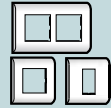

P. 253-254
White & black plastic plates

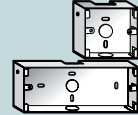

P. 254
Flush mounting & surface boxes



**Mylinc™
Wiring**

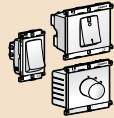

P. 258
White mechanism switches, dimmers and accessories and remote unit

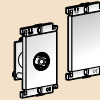

P. 258-259
White mechanism- TV and RJ 11 telephone sockets and accessories

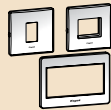

P. 260
Matt grey mechanism and USB charger

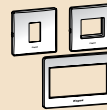

P. 261-262
Mylinc modular plates- matt grey, pearl white, champagne, silver alu, dark bronze



**Lyncus™
Wiring
Accessories**



P. 266
White mechanism switches, push buttons, standard sockets

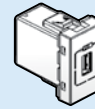

P. 267
USB chargers

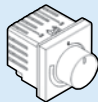

P. 268
Chic grey mechanism-switches, push buttons, dimmer and regulators, accessories



P.268
Hospitality functions, data voice, pre terminated



**Allzy
Wiring
Accessories**

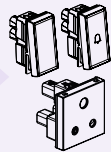

P. 278
White mechanisms - switches, sockets & dimmer and fan regulators



P. 278-279
White mechanisms - hospitality functions, sockets & connectors and protectors and accessories



**Britzy™
Wiring
Accessories**

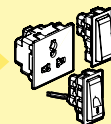

P. 284
Switches, sockets and push buttons

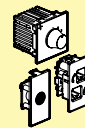

P. 284-285
Data & voice, television sockets, dimmers & regulators & accessories



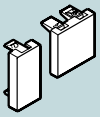

P. 251-252
Anti-Bacterial switches
and accessories

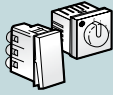

P. 252-253
Black mechanism-switches,
push buttons, sockets, power
units and dimmer and regulators

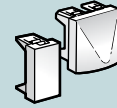

P. 253
Hospitality functions, sockets,
electronic function



P. 259
Mylinec
white modular plates

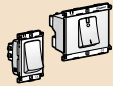

P. 259
Matt grey mechanism

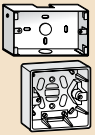

P. 262
Mylinec white
surrounds, flush, plastic and
surface boxes

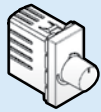

P.266-267
Dimmer and
regulators,
hospitality functions

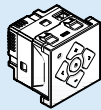

P.267-268
Sound diffusion
and loud speakers, universal
dimmers, touch switches, reading
lights

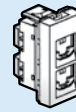

P.267
Data voice,
pre terminated audio video
connectors



P. 269
Audio video
connectors, USB
chargers



P. 269-272
Plate & frame
white, chic grey, brushed
silver, alu sunset,
champagne, matt silver

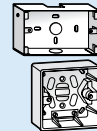

P. 272
Metal flush box &
plastic surface
boxes

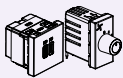

P. 279
White mechanisms -
electronic functions

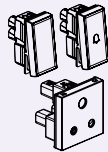

P. 279-280
Matt black mechanisms- switches, sockets
& dimmer and fan regulators, electronic
duntions, hospitality functions, sockets &
connectors and protectors and accessories

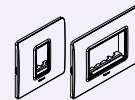

P. 280-281
Plate, frame,
boxes, flush
metal box and
surface box

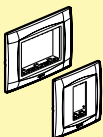

P. 285
White plate, warm orange silver,
herb beige, urban bronze,
orange chrome with frame

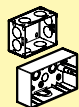

P. 285
Flush & surface
mounting boxes



Cable Management System and Accessories

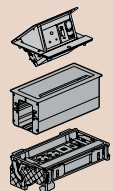

P. 299
Incara Pop-up,
Top Access,
Flip-up



NEW!
P. 301
Desktop Power
Center



NEW!
P. 303
Disq 60 & 80



P. 316-317
Selection chart:
Snap-on trunking



P. 318-319
Selection chart:
DLP PVC
adaptable trunking
system



P. 320-321
Selection chart :
DLP aluminium
Trunking system

VDI Structured Cabling

P. 331
LCS³,
Basic PDU

P. 331-332
Linkeo DC
PDU & Power cords

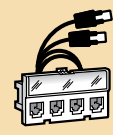

P. 332
LCS³,
cat. 6



P. 333-336
LCS³,
cat. 6A patch
panels, RJ 45,
cables and cords

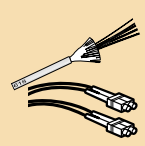

P. 341
LCS³,
audio/video patch
panel chord
cables

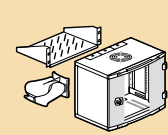

P. 342-343
Modular panels
cassettes for LCS³
fibre optic drawers

P. 343
LCS³ pigtails,
case and
quick-connect
connectors

Movement Detectors and Door Phones

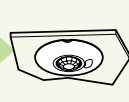

P. 349
Movement
detectors

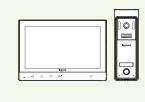

P. 349
Video door entry
system

P17 Tempra Pro, Hypra and Plugs & Sockets



P. 354
P17 Tempra Pro
sockets

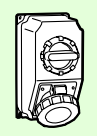

P. 354-355
P17 Tempra Pro for refrigerated container





P. 305
Pop-up box
- floor

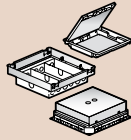

P. 309-311
Floor Solution



P. 312-313
Selection chart:
concrete floor

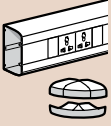

P. 322
DLP snap-on trunking
45 mm, routing
sections and
accessories

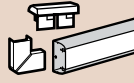

P. 323
DLP PVC trunking
system, trunking,
mini-trunking and
accessories

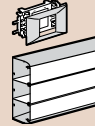

P. 324
DLP-S
PVC trunking
system and trunking
accessories

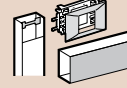

P. 324-325
DLP aluminium
adaptable trunking
system, aluminium
snap-on columns

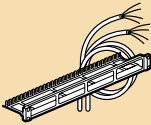

P. 337-338
LCS³,
cat. 5E patch
panels, cables
and cords, RJ 45

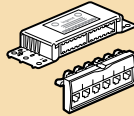

P. 338-339
LCS³,
cat. Splitter sockets, adapters
and accessories

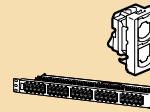

P. 339-341
LCS³, audio/video
preterminated
sockets

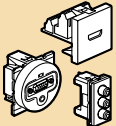

P. 343-344
9" fibre optic drawers,
LCS³ fibre optic blocks

P. 344-345
Patch chords



P. 356
Hypra industrial plugs and sockets



Smart Innovation: Around The World

Legrand Group is a global specialist in electrical and digital building infrastructure, offering smart solutions across the residential, commercial, hospitality, and industrial sectors. This strong capability has positioned Legrand as the preferred choice of discerning customers in nearly 180 countries worldwide.

Our purpose is to improve lives by transforming the spaces where people live, work and meet by delivering electrical and digital infrastructures and connected solutions that are simple, innovative and sustainable.

Guided by its philosophy of “Listen, Design, Make, and Support”, Legrand closely tracks evolving lifestyles and customer needs. The Group designs high value-added products that seamlessly integrate advanced technology, ergonomic excellence, and refined aesthetics. Through smart ideas, sleek designs, and intuitive simplicity, Legrand aims to help every customer experience a simpler, better quality of life.

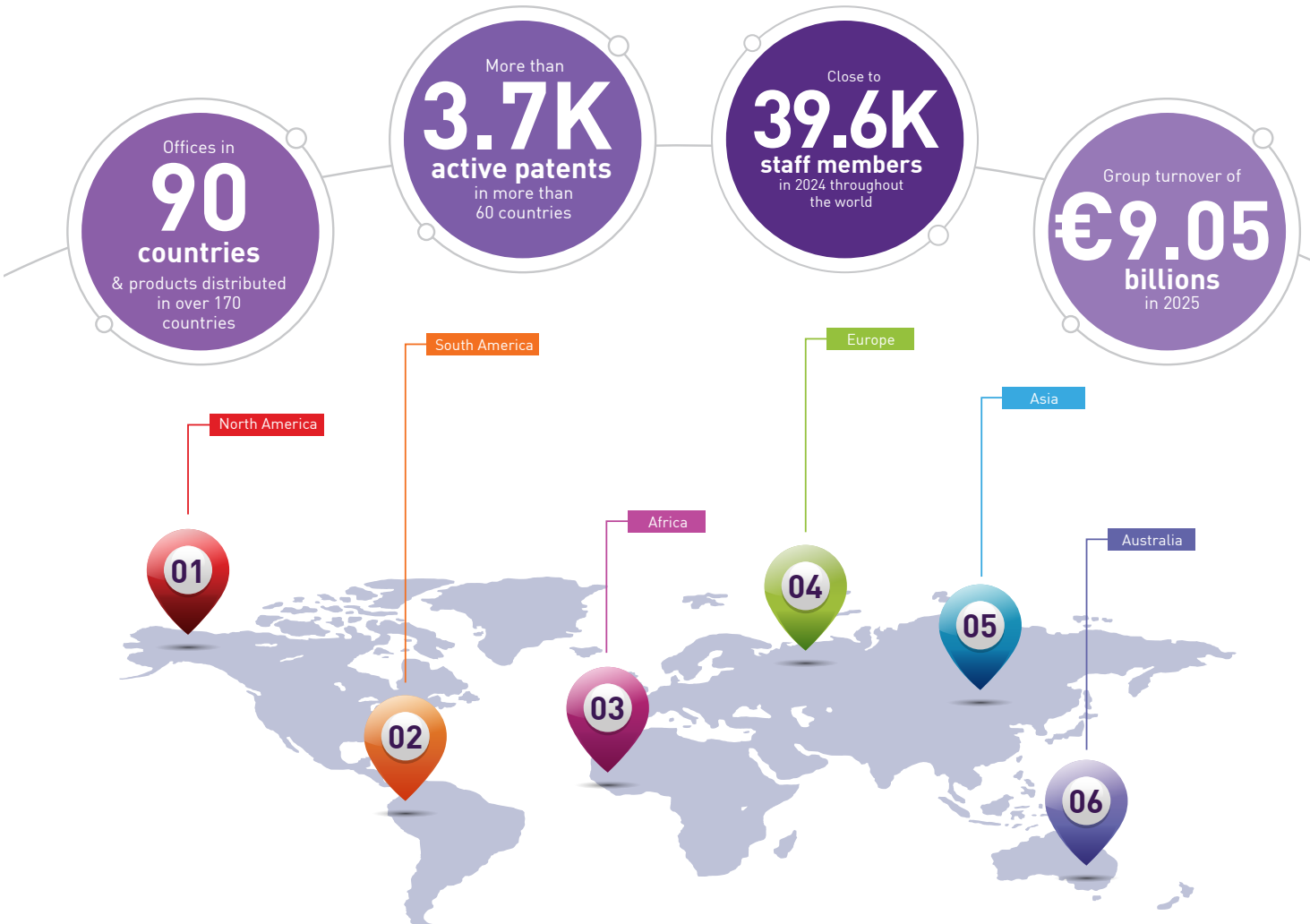

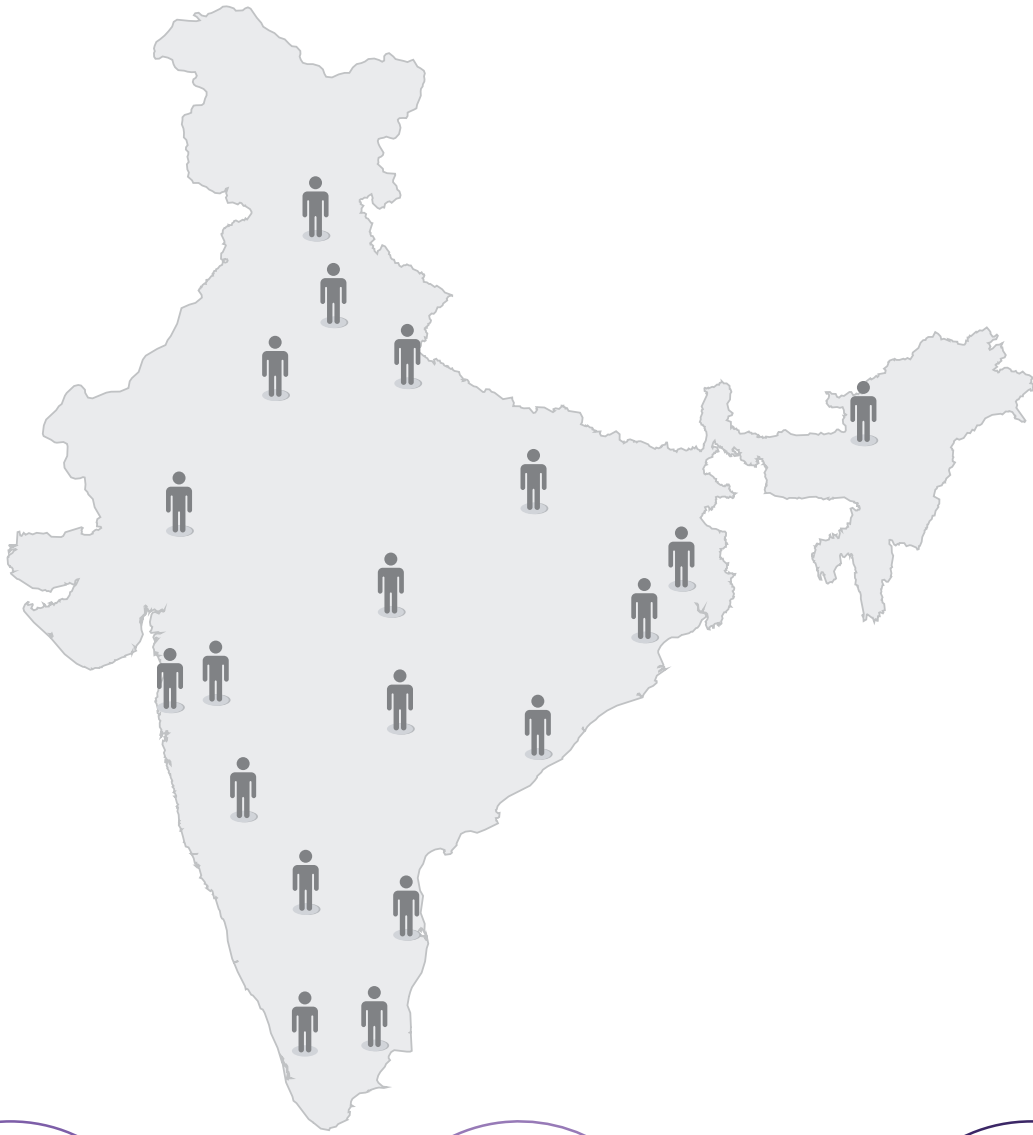

91+ OFFICES
spread across
the country

OVER 5000+
EMPLOYEES
in India

07
MANUFACTURING
facilities

3
R&D
centers

22
INNOVALS
& **3 CENTERS OF**
EXCELLENCE

An extensive network of over **870**
distribution partners and **18000** retailers

The Global Specialist

A comprehensive solution for your Electrical and Digital Building Infrastructure.

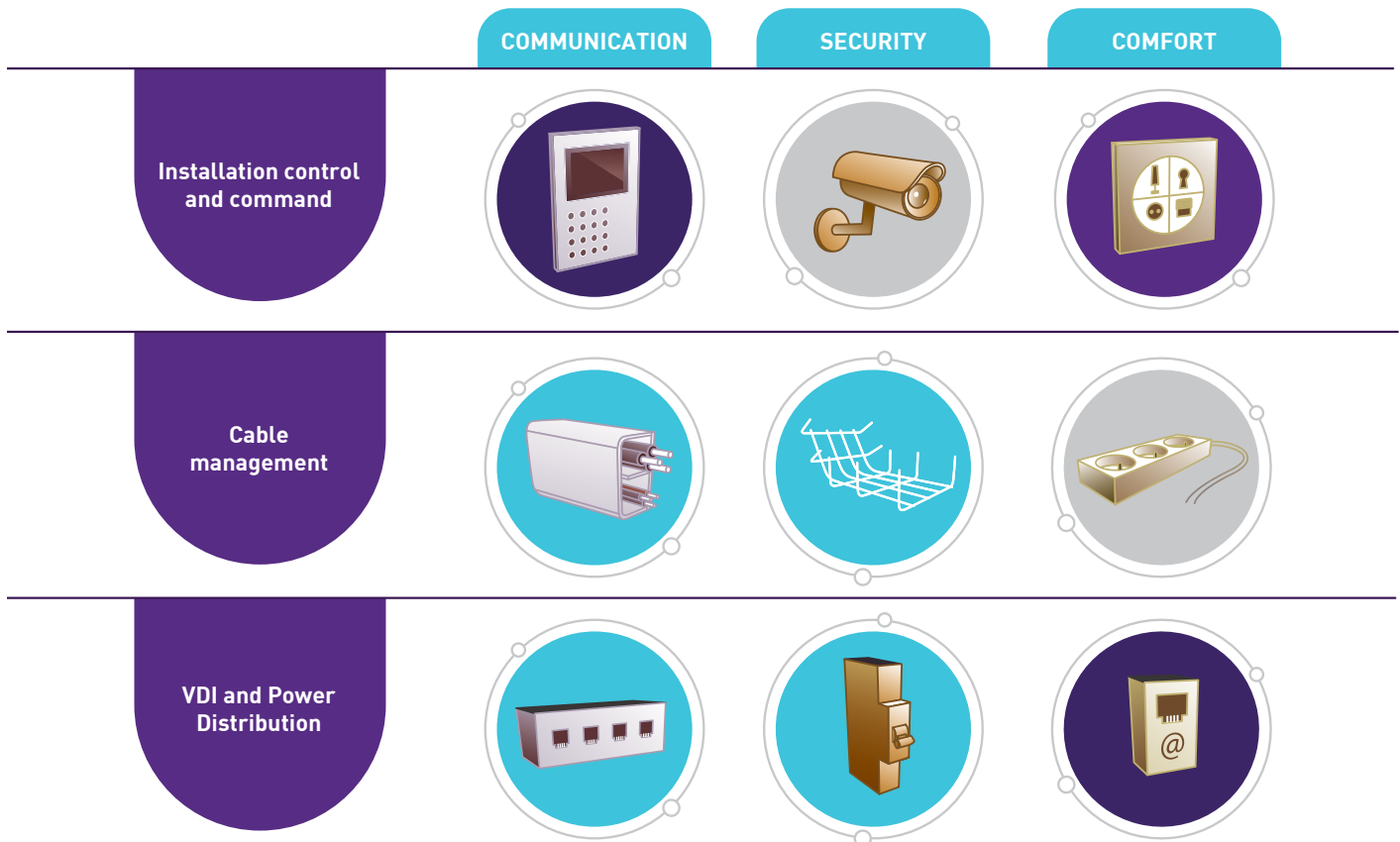

Global Specialist in Electrical and Digital Building Infrastructure

Legrand is a global specialist in electrical and digital building infrastructures, delivering solutions for homes, data centers, commercial, healthcare, hospitality, and industrial spaces. With nearly 300,000 product references, Legrand holds No. 1 or No. 2 positions in most markets worldwide.

Continuous Innovation

Over 2200 people work at our engineering and design offices, innovating simple and sustainable solutions.

Product Design – A lever for differentiation

Design is integral to our overall strategy and lies at the core of everything we do at Legrand. More than aesthetics alone, design is about enhancing the overall customer experience.

A Landmark Infrastructure Built with Purpose, Rooted in Trust



A massive infrastructure spanning 30000+ sqm, one of the largest factories for Legrand worldwide and India, was inaugurated recently at Nashik, Maharashtra. This factory assumes great significance not just for its investments and massive scale but also for its growth lever placing India at the centre of the Group's ambitions. The factory will soon be a certified green building by IGBC, with a 1 MW roof top solar installation and has been thoughtfully designed, keeping sustainability at the core of its planning.

PRODUCTS:

Our new Nashik factory is designed to manufacture Bus Bar Trunking Systems (BBTS), Distribution Boards (DBs), Server Racks, Cablofil and Industrial plugs and sockets. The factory is all set to supply products both to the local market and for export, with shipments of BBTs and industrial plug and sockets already reaching international destinations. Plans are in place to expand exports to include DBs and Cablofil products, positioning our India factory as a global supply hub with significant capacity and agility.



Our Values to Improve Lives



WE SEIZE THE FUTURE

We seize the future by creating lasting, high performance solutions for every kind of building, driven by the vision and talent of our teams



WE EMBRACE INCLUSION

We embrace inclusion by welcoming diversity among our customers, our people, and our partners, and turning it into a strength and opportunity



WE MOVE IN SYNC

We grow stronger together - collaborating with people, brands, and partners to shape a connected and future-ready electrical ecosystem



WE STRIVE FOR SIMPLICITY

We turn challenges into opportunities, creating purposeful innovations that deliver real value across every corner of the electrical sector



WE ARE DEPENDABLE

We are dependable, guided by reliability and sustainability. For over 150 years, we've built trust through responsible design and ethical relationships with our customers

Our Commitment to Sustainability



At Legrand, sustainability is a key consideration in our product development process.

Every product is crafted with a "**Eco Design**" approach, blending innovation with eco-friendly practices right from the start.

Our Product Environmental Profile (PEP) offers clear and reliable insights into the environmental impact of our products. By supporting green building initiatives and promoting eco-conscious choices, we ensure every product plays a role in building a more sustainable future.



A Landmark Infrastructure Built with Purpose, Rooted in Trust

Community Initiatives

Legrand Empowering Scholarship

Program Started in 2018, this initiative supports meritorious girl students from lower socio-economic backgrounds in Engineering, Architecture, Science, and Technology. To date, over 700+ students have been enrolled, including 66 differently abled and 25 LGBTQ+ students.

Annually, more than 100 new scholarships are awarded. Additionally, each year over 50 students receive mentorship assistance from Legrand Subject Matter Experts, till date over 150 students have been mentored to be the Future Women Leaders.



Legrand Telemedicine Center

Through our 3 centres located in Jalgaon, Haridwar, and Rohad, we offer free consultations, tests, and medicines in partnership with Apollo Hospitals. This initiative benefits over 10,000 community members annually and has positively impacted more than 72000 lives to date.

Center of Excellence - Mathura, Dehradun & Bangalore

The centers at Mathura, ITI Niranjanpur, Dehradun & Bangalore aim to provide advanced training in Electrical & UPS systems. These centers focus on enhancing students' skills and improving their job opportunities. Over 168 ITI students have been trained and over 10 have been placed as service engineers in our company.



Beach Clean-Up

Legrand adopted four beaches in Mumbai. This initiative aims to remove plastic waste and recycle it. Since September 2023, through the collective efforts of over 13992 volunteers, more than 134676 kg / 134.6 T of plastic has been collected and recycled into ten benches which were further donated to public spaces and schools.



Water Table Recharge

Legrand has recharged over 100 community borewells in rural and tribal areas using a patented technology that recharges 15–20 lakh litres of groundwater annually, directly providing clean water access to more than 5,000 individuals.



Intelligent EI

SMARTNESS THAT
MAKES A DIFFERENCE

- Advanced Protection Intelligence
- Real-time Monitoring & Metering
- Event & Fault Data Logging
- Communication Ready
- User Access Control (Password Protection)

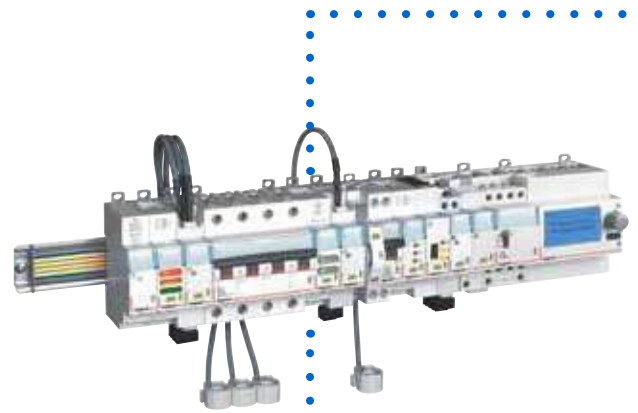

**PROGRAMMING
AND DISPLAY**



COMMUNICATION



MEASUREMENT



SIGNALLING



CONTROL



Scan to know more about
the product.



**SIGNALLING
AND CONTROL**



CX³

A Smart Platform For Your Energy Management Needs

- Smart & Connected Ready
- Compact & Modular Design
- Versatile Load Control



WEB SERVER



ACBs



MCCB'S



**MEASURING
UNIT**



WATER



GAS



Scan to know more about the product.



BMS/SCADA

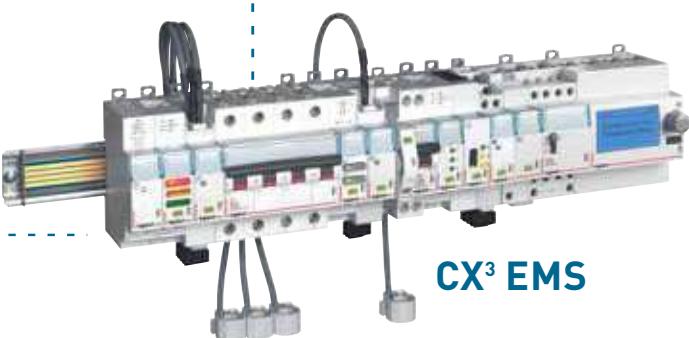

CX³ EMS



**ENERGY
METER**



ELECTRICITY

DMX³

Air Circuit Breakers

Smarter Protection for Critical Power Systems



Scan to know more about the product.



DMX³ Air Circuit Breakers

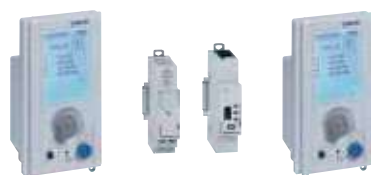

- Range – 630 A to 6300 A
- Three Optimum Frame Sizes
- Breaking Capacities of 50 kA, 65 kA & 100 kA
- Advanced Self Powered Electronic Protection Units
- MP4.10 and MP4.10M LCD Protection Units
- Long time delay protection against overloads I_r from 0.2 to 1 x I_n with (Steps 1A) - OFF
- Long delay protection operation time t_r = 40 ms + 30 s (step 40)
- Short time delay protection against short-circuits I_{sd} from 1,5I_r to 10 I_r with - OFF (step 1A)
- Short time delay protection operation time (t=k, I₂t=k) t_{sd} = 40 ms + 1 s (steps 40 ms)
- Instantaneous protection against very high short-circuits I_i from 2 to 15 I_n - OFF (step 1A)
- Earth fault current I_g from 0.2 + 1 I_n - OFF (step 0.1I_n)
- Time delay on earth fault tripping (t=k, I₂t=k) t_g from 80 ms + 1s with (step 40 ms)
- Neutral protection I_N = 50% - 100% - 150% - 200% - OFF
- Communication Capable
- In Built Temperature Protection
- Rotatable Terminals for Horizontal/Vertical Orientation^(*)
- Fast Operation
- Options to install various safety interlock
- Internal Battery for Trip Units
- Individual fault diagnosis
- Individual Fault Counter & Historical Trip Record
- Option to Measure Current, Voltage, Frequency, Power, Energy, Individual Harmonics, THD, Power Factor and internal battery voltage
- Switchable Thermal Memory

| DMX ³ | 1 | 08 | N | 4 | E | D | 4N |
|------------------------|--|--|-----------------------------|--------------------|--|----------------------|--|
| ↓ | ↓ | ↓ | ↓ | ↓ | ↓ | ↓ | ↓ |
| CB Series | Frame | Rating | BC | No. of Poles | Type of Spring Charging | Type of Mechanism | Type of Release |
| DMX3= DMX ³ | 1=DMX ³ 2500 2=DMX ³ 4000 | 06=630A 08=800A 10=1000A 12=1250A 16=1600A 20=2000A 25=2500A 32=3200A 40=4000A | N=50kA H=65kA L=100kA | 3=3Pole 4=4Pole | M=Manual Type E=Electrical with 240V AC ECD+CC & 240V AC S/T | F=Fixed D=Drawout | 00=Trip Free 4N=MP4.10 LSIG 4M=MP4.10 LSIG with Measurement |

| Type and frame size | Rated Current (A) | 3P | | | 4P | | |
|---------------------|-------------------|---------|-------------|------|---------|-------------|------|
| | | Cat.Nos | MRP*/₹/Unit | Pack | Cat.Nos | MRP*/₹/Unit | Pack |

Manual Fixed Version With MP4.10 PU

| | | | | | | | |
|--|---------------|---------------|---|---------------|---------------|---|---|
| DMX ³ - N 2500, Icu 50 kA Frame - 1 | 630 A | DMX3106N3MF4N | ■ | 1 | DMX3106N4MF4N | ■ | 1 |
| | 800 A | DMX3108N3MF4N | ■ | 1 | DMX3108N4MF4N | ■ | 1 |
| | 1000 A | DMX3110N3MF4N | ■ | 1 | DMX3110N4MF4N | ■ | 1 |
| | 1250 A | DMX3112N3MF4N | ■ | 1 | DMX3112N4MF4N | ■ | 1 |
| | 1600 A | DMX3116N3MF4N | ■ | 1 | DMX3116N4MF4N | ■ | 1 |
| | 2000 A | DMX3120N3MF4N | ■ | 1 | DMX3120N4MF4N | ■ | 1 |
| | 2500 A | DMX3125N3MF4N | ■ | 1 | DMX3125N4MF4N | ■ | 1 |
| DMX ³ -N 4000 Icu 50 kA Frame - 2 | 3200 A | DMX3232N3MF4N | ■ | 1 | DMX3232N4MF4N | ■ | 1 |
| | 4000 A | DMX3240N3MF4N | ■ | 1 | DMX3240N4MF4N | ■ | 1 |
| DMX ³ - H 2500, Icu 65 kA Frame - 1 | 630 A | DMX3106H3MF4N | ■ | 1 | DMX3106H4MF4N | ■ | 1 |
| | 800 A | DMX3108H3MF4N | ■ | 1 | DMX3108H4MF4N | ■ | 1 |
| | 1000 A | DMX3110H3MF4N | ■ | 1 | DMX3110H4MF4N | ■ | 1 |
| | 1250 A | DMX3112H3MF4N | ■ | 1 | DMX3112H4MF4N | ■ | 1 |
| | 1600 A | DMX3116H3MF4N | ■ | 1 | DMX3116H4MF4N | ■ | 1 |
| | 2000 A | DMX3120H3MF4N | ■ | 1 | DMX3120H4MF4N | ■ | 1 |
| 2500 A | DMX3125H3MF4N | ■ | 1 | DMX3125H4MF4N | ■ | 1 | |



DMX3240L4MF4N

■ Price available on request.

* MRP - Maximum Retail Price Inclusive of all taxes including GST.

^(*)Built in bothside rotatable terminals up to 1600A as a standard offer.

Bold Cat.Nos are products normally available with Legrand (India) Stockists. Cat.Nos that are not bold - delivery within 4 - 8 weeks from the date of order. Bold packing quantity is our mandatory packing. Orders to be placed by Legrand (India) Stockist in multiples of the same.

DMX³ Air Circuit Breakers

| Type and frame size | Rated Current (A) | 3P | | | 4P | | |
|---|-------------------|---------------|-------------|------|---------------|-------------|------|
| | | Cat.Nos | MRP*/₹/Unit | Pack | Cat.Nos | MRP*/₹/Unit | Pack |
| Manual Fixed Version with MP4.10 PU | | | | | | | |
| DMX ³ - H 4000 Icu 65KA Frame 2 | 3200 A | DMX3232H3MF4N | ■ | 1 | DMX3232H4MF4N | ■ | 1 |
| | 4000 A | DMX3240H3MF4N | ■ | 1 | DMX3240H4MF4N | ■ | 1 |
| DMX ³ - L 2500 Icu 100KA Frame 2 | 630 A | DMX3206L3MF4N | ■ | 1 | DMX3206L4MF4N | ■ | 1 |
| | 800 A | DMX3208L3MF4N | ■ | 1 | DMX3208L4MF4N | ■ | 1 |
| | 1000 A | DMX3210L3MF4N | ■ | 1 | DMX3210L4MF4N | ■ | 1 |
| | 1250 A | DMX3212L3MF4N | ■ | 1 | DMX3212L4MF4N | ■ | 1 |
| | 1600 A | DMX3216L3MF4N | ■ | 1 | DMX3216L4MF4N | ■ | 1 |
| | 2000 A | DMX3220L3MF4N | ■ | 1 | DMX3220L4MF4N | ■ | 1 |
| | 2500 A | DMX3225L3MF4N | ■ | 1 | DMX3225L4MF4N | ■ | 1 |
| DMX ³ - L 4000 Icu 100KA Frame 2 | 3200 A | DMX3232L3MF4N | ■ | 1 | DMX3232L4MF4N | ■ | 1 |
| | 4000 A | DMX3240L3MF4N | ■ | 1 | DMX3240L4MF4N | ■ | 1 |
| DMX ³ - L 6300 Icu 100KA Frame 3 | 5000 A | 0284 80 | ■ | 1 | 0284 82 | ■ | 1 |
| | 6300 A | 0284 81 | ■ | 1 | 0284 83 | ■ | 1 |

Manual Drawout Version with MP 4.10 PU



DMX3108N3MD4N

| | | | | | | | |
|---|--------|---------------|---|---|---------------|---|---|
| DMX ³ - N 2500 Icu 50KA Frame 1 | 630 A | DMX3106N3MD4N | ■ | 1 | DMX3106N4MD4N | ■ | 1 |
| | 800 A | DMX3108N3MD4N | ■ | 1 | DMX3108N4MD4N | ■ | 1 |
| | 1000 A | DMX3110N3MD4N | ■ | 1 | DMX3110N4MD4N | ■ | 1 |
| | 1250 A | DMX3112N3MD4N | ■ | 1 | DMX3112N4MD4N | ■ | 1 |
| | 1600 A | DMX3116N3MD4N | ■ | 1 | DMX3116N4MD4N | ■ | 1 |
| | 2000 A | DMX3120N3MD4N | ■ | 1 | DMX3120N4MD4N | ■ | 1 |
| | 2500 A | DMX3125N3MD4N | ■ | 1 | DMX3125N4MD4N | ■ | 1 |
| DMX ³ - N 4000 Icu 50KA Frame 2 | 3200 A | DMX3232N3MD4N | ■ | 1 | DMX3232N4MD4N | ■ | 1 |
| | 4000 A | DMX3240N3MD4N | ■ | 1 | DMX3240N4MD4N | ■ | 1 |
| DMX ³ - H 2500 Icu 65KA Frame 1 | 630 A | DMX3106H3MD4N | ■ | 1 | DMX3106H4MD4N | ■ | 1 |
| | 800 A | DMX3108H3MD4N | ■ | 1 | DMX3108H4MD4N | ■ | 1 |
| | 1000 A | DMX3110H3MD4N | ■ | 1 | DMX3110H4MD4N | ■ | 1 |
| | 1250 A | DMX3112H3MD4N | ■ | 1 | DMX3112H4MD4N | ■ | 1 |
| | 1600 A | DMX3116H3MD4N | ■ | 1 | DMX3116H4MD4N | ■ | 1 |
| | 2000 A | DMX3120H3MD4N | ■ | 1 | DMX3120H4MD4N | ■ | 1 |
| | 2500 A | DMX3125H3MD4N | ■ | 1 | DMX3125H4MD4N | ■ | 1 |
| DMX ³ - H 4000 Icu 65KA Frame 2 | 3200 A | DMX3232H3MD4N | ■ | 1 | DMX3232H4MD4N | ■ | 1 |
| | 4000 A | DMX3240H3MD4N | ■ | 1 | DMX3240H4MD4N | ■ | 1 |
| DMX ³ - L 2500 Icu 100KA Frame 2 | 630 A | DMX3206L3MD4N | ■ | 1 | DMX3206L4MD4N | ■ | 1 |
| | 800 A | DMX3208L3MD4N | ■ | 1 | DMX3208L4MD4N | ■ | 1 |
| | 1000 A | DMX3210L3MD4N | ■ | 1 | DMX3210L4MD4N | ■ | 1 |
| | 1250 A | DMX3212L3MD4N | ■ | 1 | DMX3212L4MD4N | ■ | 1 |
| | 1600 A | DMX3216L3MD4N | ■ | 1 | DMX3216L4MD4N | ■ | 1 |
| | 2000 A | DMX3220L3MD4N | ■ | 1 | DMX3220L4MD4N | ■ | 1 |
| | 2500 A | DMX3225L3MD4N | ■ | 1 | DMX3225L4MD4N | ■ | 1 |
| DMX ³ - L 4000 Icu 100KA Frame 2 | 3200 A | DMX3232L3MD4N | ■ | 1 | DMX3232L4MD4N | ■ | 1 |
| | 4000 A | DMX3240L3MD4N | ■ | 1 | DMX3240L4MD4N | ■ | 1 |
| DMX ³ - L 6300 Icu 100KA Frame 3 | 5000 A | 0284 85 | ■ | 1 | 0284 87 | ■ | 1 |
| | 6300 A | 0284 86 | ■ | 1 | 0284 88 | ■ | 1 |

* MRP - Maximum Retail Price Inclusive of all taxes including GST.
■ Price available on request.

Bold Cat.Nos are products normally available with Legrand (India) Stockists.
Cat.Nos that are not bold - delivery within 4 - 8 weeks from the date of order.
Bold packing quantity is our mandatory packing. Orders to be placed by Legrand (India) Stockist in multiples of the same.

DMX³

Electronic Protection Units

| Type and frame size | Rated Current (A) | 3P | | | 4P | | |
|---------------------|-------------------|---------|-------------|------|---------|-------------|------|
| | | Cat.Nos | MRP*/₹/Unit | Pack | Cat.Nos | MRP*/₹/Unit | Pack |

Electrical Fixed Version with MP4.10 PU with 240V AC, ECD+CC & 240V AC S/T

| | | | | | | | |
|---|--------|---------------|---|---|---------------|---|---|
| DMX ³ - N 2500 Icu 50KA Frame 1 | 630 A | DMX3106N3EF4N | ■ | 1 | DMX3106N4EF4N | ■ | 1 |
| | 800 A | DMX3108N3EF4N | ■ | 1 | DMX3108N4EF4N | ■ | 1 |
| | 1000 A | DMX3110N3EF4N | ■ | 1 | DMX3110N4EF4N | ■ | 1 |
| | 1250 A | DMX3112N3EF4N | ■ | 1 | DMX3112N4EF4N | ■ | 1 |
| | 1600 A | DMX3116N3EF4N | ■ | 1 | DMX3116N4EF4N | ■ | 1 |
| | 2000 A | DMX3120N3EF4N | ■ | 1 | DMX3120N4EF4N | ■ | 1 |
| | 2500 A | DMX3125N3EF4N | ■ | 1 | DMX3125N4EF4N | ■ | 1 |
| DMX ³ - N 4000 Icu 50KA Frame 2 | 3200 A | DMX3232N3EF4N | ■ | 1 | DMX3232N4EF4N | ■ | 1 |
| | 4000 A | DMX3240N3EF4N | ■ | 1 | DMX3240N4EF4N | ■ | 1 |
| DMX ³ - H 2500 Icu 65KA Frame 1 | 630 A | DMX3106H3EF4N | ■ | 1 | DMX3106H4EF4N | ■ | 1 |
| | 800 A | DMX3108H3EF4N | ■ | 1 | DMX3108H4EF4N | ■ | 1 |
| | 1000 A | DMX3110H3EF4N | ■ | 1 | DMX3110H4EF4N | ■ | 1 |
| | 1250 A | DMX3112H3EF4N | ■ | 1 | DMX3112H4EF4N | ■ | 1 |
| | 1600 A | DMX3116H3EF4N | ■ | 1 | DMX3116H4EF4N | ■ | 1 |
| | 2000 A | DMX3120H3EF4N | ■ | 1 | DMX3120H4EF4N | ■ | 1 |
| | 2500 A | DMX3125H3EF4N | ■ | 1 | DMX3125H4EF4N | ■ | 1 |
| DMX ³ - H 4000 Icu 65KA Frame 2 | 3200 A | DMX3232H3EF4N | ■ | 1 | DMX3232H4EF4N | ■ | 1 |
| | 4000 A | DMX3240H3EF4N | ■ | 1 | DMX3240H4EF4N | ■ | 1 |
| DMX ³ - L 2500 Icu 100KA Frame 2 | 630 A | DMX3206L3EF4N | ■ | 1 | DMX3206L4EF4N | ■ | 1 |
| | 800 A | DMX3208L3EF4N | ■ | 1 | DMX3208L4EF4N | ■ | 1 |
| | 1000 A | DMX3210L3EF4N | ■ | 1 | DMX3210L4EF4N | ■ | 1 |
| | 1250 A | DMX3212L3EF4N | ■ | 1 | DMX3212L4EF4N | ■ | 1 |
| | 1600 A | DMX3216L3EF4N | ■ | 1 | DMX3216L4EF4N | ■ | 1 |
| | 2000 A | DMX3220L3EF4N | ■ | 1 | DMX3220L4EF4N | ■ | 1 |
| | 2500 A | DMX3225L3EF4N | ■ | 1 | DMX3225L4EF4N | ■ | 1 |
| DMX ³ - L 4000 Icu 100KA Frame 2 | 3200 A | DMX3232L3EF4N | ■ | 1 | DMX3232L4EF4N | ■ | 1 |
| | 4000 A | DMX3240L3EF4N | ■ | 1 | DMX3240L4EF4N | ■ | 1 |

Electrical Drawout Version with MP 4.10 PU with 240V AC, ECD+CC & 240V AC S/T

| | | | | | | | |
|--|--------|---------------|---|---|---------------|---|---|
| DMX ³ - N 2500 Icu 50KA Frame 1 | 630 A | DMX3106N3ED4N | ■ | 1 | DMX3106N4ED4N | ■ | 1 |
| | 800 A | DMX3108N3ED4N | ■ | 1 | DMX3108N4ED4N | ■ | 1 |
| | 1000 A | DMX3110N3ED4N | ■ | 1 | DMX3110N4ED4N | ■ | 1 |
| | 1250 A | DMX3112N3ED4N | ■ | 1 | DMX3112N4ED4N | ■ | 1 |
| | 1600 A | DMX3116N3ED4N | ■ | 1 | DMX3116N4ED4N | ■ | 1 |
| | 2000 A | DMX3120N3ED4N | ■ | 1 | DMX3120N4ED4N | ■ | 1 |
| | 2500 A | DMX3125N3ED4N | ■ | 1 | DMX3125N4ED4N | ■ | 1 |
| DMX ³ - N 4000 Icu 50KA Frame 2 | 3200 A | DMX3232N3ED4N | ■ | 1 | DMX3232N4ED4N | ■ | 1 |
| | 4000 A | DMX3240N3ED4N | ■ | 1 | DMX3240N4ED4N | ■ | 1 |



DMX3112N3ED4N

* MRP - Maximum Retail Price Inclusive of all taxes including GST.
■ Price available on request.

Bold Cat.Nos are products normally available with Legrand (India) Stockists. Cat.Nos that are not bold - delivery within 4 - 8 weeks from the date of order. Bold packing quantity is our mandatory packing. Orders to be placed by Legrand (India) Stockist in multiples of the same.

DMX³ Air Circuit Breakers

| Type and frame size | Rated Current (A) | 3P | | | 4P | | |
|---------------------|-------------------|---------|-------------|------|---------|-------------|------|
| | | Cat.Nos | MRP*/₹/Unit | Pack | Cat.Nos | MRP*/₹/Unit | Pack |

Electrical Drawout Version with MP 4.10 PU with 240V AC, ECD+CC & 240V AC S/T

| | | | | | | | |
|---|--------|---------------|---|---|---------------|---|---|
| DMX ³ - H 2500 Icu 65KA Frame 1 | 630 A | DMX3106H3ED4N | ■ | 1 | DMX3106H4ED4N | ■ | 1 |
| | 800 A | DMX3108H3ED4N | ■ | 1 | DMX3108H4ED4N | ■ | 1 |
| | 1000 A | DMX3110H3ED4N | ■ | 1 | DMX3110H4ED4N | ■ | 1 |
| | 1250 A | DMX3112H3ED4N | ■ | 1 | DMX3112H4ED4N | ■ | 1 |
| | 1600 A | DMX3116H3ED4N | ■ | 1 | DMX3116H4ED4N | ■ | 1 |
| | 2000 A | DMX3120H3ED4N | ■ | 1 | DMX3120H4ED4N | ■ | 1 |
| | 2500 A | DMX3125H3ED4N | ■ | 1 | DMX3125H4ED4N | ■ | 1 |
| DMX ³ - H 4000 Icu 65KA Frame 2 | 3200 A | DMX3232H3ED4N | ■ | 1 | DMX3232H4ED4N | ■ | 1 |
| | 4000 A | DMX3240H3ED4N | ■ | 1 | DMX3240H4ED4N | ■ | 1 |
| DMX ³ - L 2500 Icu 100KA Frame 2 | 630 A | DMX3206L3ED4N | ■ | 1 | DMX3206L4ED4N | ■ | 1 |
| | 800 A | DMX3208L3ED4N | ■ | 1 | DMX3208L4ED4N | ■ | 1 |
| | 1000 A | DMX3210L3ED4N | ■ | 1 | DMX3210L4ED4N | ■ | 1 |
| | 1250 A | DMX3212L3ED4N | ■ | 1 | DMX3212L4ED4N | ■ | 1 |
| | 1600 A | DMX3216L3ED4N | ■ | 1 | DMX3216L4ED4N | ■ | 1 |
| | 2000 A | DMX3220L3ED4N | ■ | 1 | DMX3220L4ED4N | ■ | 1 |
| | 2500 A | DMX3225L3ED4N | ■ | 1 | DMX3225L4ED4N | ■ | 1 |
| DMX ³ - L 4000 Icu 100KA Frame 2 | 3200 A | DMX3232L3ED4N | ■ | 1 | DMX3232L4ED4N | ■ | 1 |
| | 4000 A | DMX3240L3ED4N | ■ | 1 | DMX3240L4ED4N | ■ | 1 |

Switch Disconnecter (Trip Free Switches) From 1250 To 6300A Manual Fixed Version

| | | | | | | | |
|---|--------|---------------|---|---|---------------|---|---|
| DMX ³ - I 2500 Frame 1 | 1250 A | DMX3112S3MF00 | ■ | 1 | DMX3112S4MF00 | ■ | 1 |
| | 1600 A | DMX3116S3MF00 | ■ | 1 | DMX3116S4MF00 | ■ | 1 |
| | 2000 A | DMX3120S3MF00 | ■ | 1 | DMX3120S4MF00 | ■ | 1 |
| | 2500 A | DMX3125S3MF00 | ■ | 1 | DMX3125S4MF00 | ■ | 1 |
| DMX ³ -I 4000 Frame 2 | 3200 A | DMX3232S3MF00 | ■ | 1 | DMX3232S4MF00 | ■ | 1 |
| | 4000 A | DMX3240S3MF00 | ■ | 1 | DMX3240S4MF00 | ■ | 1 |
| DMX ³ - L 4000 Icu 100KA Frame 2 | 6300 A | 0282 88 | ■ | 1 | 0282 89 | ■ | 1 |

Manual Drawout Version

| | | | | | | | |
|--------------------------------------|--------|---------------|---|---|---------------|---|---|
| DMX ³ - I 2500 Frame 1 | 1250 A | DMX3112S3MD00 | ■ | 1 | DMX3112S4MD00 | ■ | 1 |
| | 1600 A | DMX3116S3MD00 | ■ | 1 | DMX3116S4MD00 | ■ | 1 |
| | 2000 A | DMX3120S3MD00 | ■ | 1 | DMX3120S4MD00 | ■ | 1 |
| | 2500 A | DMX3125S3MD00 | ■ | 1 | DMX3125S4MD00 | ■ | 1 |
| DMX ³ -I 4000 Frame 2 | 3200 A | DMX3232S3MD00 | ■ | 1 | DMX3232S4MD00 | ■ | 1 |
| | 4000 A | DMX3240S3MD00 | ■ | 1 | DMX3240S4MD00 | ■ | 1 |
| DMX ³ -I-6300 Frame 3 | 6300 A | 0282 98 | ■ | 1 | 0282 99 | ■ | 1 |

* MRP - Maximum Retail Price Inclusive of all taxes including GST.
■ Price available on request.

- Note - 1. For Voltages other than 220 - 250 V AC and DC, please order MF/MDO ACB and the required Voltage accessories
2. For Frame 3 ACB, consider Individual Internal and External Accessories as per requirement.
3. For EF and EDO versions of Switch-disconnectors, please contact Sales office.

Bold Cat.Nos are products normally available with Legrand (India) Stockists. Cat.Nos that are not bold - delivery within 4 - 8 weeks from the date of order. Bold packing quantity is our mandatory packing. Orders to be placed by Legrand (India) Stockist in multiples of the same.



DMX3120S3MD00

DMX³ Air Circuit Breakers

| Cat.Nos | Description | MRP*/₹/Unit | Pack |
|---------|-------------|-------------|------|
|---------|-------------|-------------|------|

Electronic Protection Units MP4.10

| | | | |
|---------|---|---|---|
| 0283 06 | MP4.10 Protection Unit with rotating encoder for Adjustment of Ir,tr,isd,tsd,li,Ig and tg Possibility to enable/disable protections With Current Measurement and LCD display protection conditions Fault signaling and log | ■ | 1 |
|---------|---|---|---|



0283 06

Electronic Protection Units MP4.10M

| | | | |
|---------|---|---|---|
| 0283 07 | MP4.10M Protection Unit with rotating encoder for Adjustment via rotating encoder Adjustment of Ir,tr,isd,tsd,li,Ig and tg Possibility to enable/disable protections With Current, Voltage, Frequency Power, Energy Measurement, individual harmonics, THD and LCD display with instantaneous, maximum and average values of different electrical values and protection conditions Fault signaling and log | ■ | 1 |
|---------|---|---|---|



0283 07

| Type and frame size | 3P | | | 4P | | |
|---------------------|---------|-------------|------|---------|-------------|------|
| | Cat.Nos | MRP*/₹/Unit | Pack | Cat.Nos | MRP*/₹/Unit | Pack |

Fixed Version

| | | | | | | |
|--|----------|---|---|----------|---|---|
| DMX ³ 2500, fixed version, frame - 1 | 0288 84 | ■ | 1 | 0288 85 | ■ | 1 |
| | 0288 82 | ■ | 1 | 0288 83 | ■ | 1 |
| DMX ³ 4000, DMX ³ 6300 fixed version, frame - 2 & 3 | 0288 92 | ■ | 1 | 0288 93 | ■ | 1 |
| DMX ³ 2500 draw-out version, Frame - 1 | 0288 96 | ■ | 1 | 0288 97 | ■ | 1 |
| DMX ³ 4000, DMX ³ 6300 draw-out version, fram - 2 & 3 | 0288 94 | ■ | 1 | 0288 95 | ■ | 1 |
| DMX ³ 2500, draw-out version, frame-1 suitable for Aluminium | 0288 96A | ■ | 1 | 0288 97A | ■ | 1 |
| DMX ³ 4000, DMX ³ 6300 draw-out version, frame - 2&3, suitable for Aluminium | 0288 94A | ■ | 1 | 0288 95A | ■ | 1 |



0288 84



0288 82



0288 96

Spreaders/Terminal Adaptors

| | | | | | | |
|---|---------|---|---|---------|---|---|
| DMX ³ 2500, fixed version, frame - 1 | 0289 02 | ■ | 1 | 0288 87 | ■ | 1 |
| | 0288 88 | ■ | 1 | 0288 89 | ■ | 1 |
| | 0288 90 | ■ | 1 | 0288 91 | ■ | 1 |



0288 91

Equipment For Conversion Of A Fixed Device Into Draw-Out Device

Bases (Cradle) For Draw-Out Device

| | | | | | | |
|---|---------|---|---|---------|---|---|
| DMX ³ /DMX ³ -I 2500, frame - 1 | 0289 02 | ■ | 1 | 0289 03 | ■ | 1 |
|---|---------|---|---|---------|---|---|

* MRP - Maximum Retail Price Inclusive of all taxes including GST.

■ Price available on request.

Red Cat. Nos - New Products

For External Neutral Sensors for DMX3 ACB, please contact sales office.

Bold Cat.Nos are products normally available with Legrand (India) Stockists. Cat.Nos that are not bold - delivery within 4 - 8 weeks from the date of order. Bold packing quantity is our mandatory packing. Orders to be placed by Legrand (India) Stockist in multiples of the same.

DMX³ Air Circuit Breakers

Equipment For Conversion Of A Fixed Device Into Draw-Out Device

Bases (Cradle) For Draw-Out Device

| | | | | | | |
|---|---------|---|---|---------|---|---|
| DMX ³ /DMX ³ -I 4000, frame - 2 | 0289 04 | ■ | 1 | 0289 05 | ■ | 1 |
| DMX ³ /DMX ³ -I 6300, frame - 3 | 0289 13 | ■ | 1 | 0289 14 | ■ | 1 |

Transformation kit for Draw-Out Version

| | | | | | | |
|---|---------|---|---|---------|---|---|
| DMX ³ /DMX ³ -I 2500, frame - 1 | 0289 09 | ■ | 1 | 0289 10 | ■ | 1 |
| DMX ³ /DMX ³ -I 4000, frame - 2 | 0289 11 | ■ | 1 | 0289 12 | ■ | 1 |
| DMX ³ /DMX ³ -I 6300, frame - 3 | 0289 15 | ■ | 1 | 0289 16 | ■ | 1 |

DMX³

Auxiliaries and Accessories

| Cat.Nos | Description | MRP* ₹ / Unit | Pack |
|---------|-------------|------------------|------|
|---------|-------------|------------------|------|

Control and Signalling Auxiliaries

Shunt Trip

| | | | |
|---------|-----------------|---|---|
| 0288 48 | 24 V \sim /= | ■ | 1 |
| 0288 49 | 48 V \sim /= | ■ | 1 |
| 0288 50 | 110 V \sim /= | ■ | 1 |
| 0288 51 | 230 V \sim /= | ■ | 1 |
| 0288 52 | 415 V \sim | ■ | 1 |



0288 51

Undervoltage Releases

| | | | |
|---------|-----------------|---|---|
| 0288 55 | 24 V \sim /= | ■ | 1 |
| 0288 56 | 48 V \sim /= | ■ | 1 |
| 0288 57 | 110 V \sim /= | ■ | 1 |
| 0288 58 | 230 V \sim /= | ■ | 1 |
| 0288 59 | 415 V \sim | ■ | 1 |



0288 58

DMX³

Auxiliaries and Accessories

| Cat.Nos | Description | MRP* ₹ / Unit | Pack |
|---------|-------------|------------------|------|
|---------|-------------|------------------|------|

Undervoltage Releases With Delay

| | | | |
|---------|-----------------|---|---|
| 0288 62 | 110 V \sim /= | ■ | 1 |
| 0288 63 | 230 V \sim /= | ■ | 1 |

Motor Operators

| | | | |
|---------|-----------------|---|---|
| 0288 34 | 24 V \sim /= | ■ | 1 |
| 0288 35 | 48 V \sim /= | ■ | 1 |
| 0288 36 | 110 V \sim /= | ■ | 1 |
| 0288 37 | 230 V \sim /= | ■ | 1 |
| 0288 38 | 415 V \sim | ■ | 1 |



0288 37

Closing Coils

| | | | |
|---------|-----------------|---|---|
| 0288 41 | 24 V \sim /= | ■ | 1 |
| 0288 42 | 48 V \sim /= | ■ | 1 |
| 0288 43 | 110 V \sim /= | ■ | 1 |
| 0288 44 | 230 V \sim /= | ■ | 1 |
| 0288 45 | 415 V \sim /= | ■ | 1 |



0288 44

* MRP - Maximum Retail Price Inclusive of all taxes including GST.
■ Price available on request.

Bold Cat.Nos are products normally available with Legrand (India) Stockists. Cat.Nos that are not bold - delivery within 4 - 8 weeks from the date of order. Bold packing quantity is our mandatory packing. Orders to be placed by Legrand (India) Stockist in multiples of the same.

DMX³ Auxiliaries and Accessories

| Cat.Nos | Description | MRP* ₹ / Unit | Pack |
|---------|-------------|------------------|------|
|---------|-------------|------------------|------|

Locking

Key Locking In "Open" Position

| | | | |
|---------|--|---|---|
| 0288 27 | Open position lock RONIS x 5 + 3 keys (Random) | ■ | 1 |
| 0288 28 | 2 hole support frame for RONIS locks | ■ | 1 |
| 4238 80 | Key barrel and flat key with random mapping | ■ | 1 |
| 4238 81 | Key barrel and flat key with fixed mapping | ■ | 1 |
| 4238 82 | Key barrel and flat key with fixed mapping | ■ | 1 |
| 4238 83 | Key barrel and star key with random mapping | ■ | 1 |
| 0281 94 | Kit for key lock in d/o position DMX3 | ■ | 1 |

Locking

Key locking in the draw out position

| | | | |
|---------|---|---|---|
| 4238 80 | Key Lock (Only lock + key) | ■ | 1 |
| 4238 83 | Key barrel and star key with random mapping | ■ | 1 |
| 0281 94 | Kit for key lock in d/o position DMX3 | ■ | 1 |

Door locking

| | | | |
|---------|--|---|---|
| 0288 20 | Left-hand and right-hand side mounting | ■ | 1 |
|---------|--|---|---|

Padlocks In "Open" Position

| | | | |
|---------|--------------------------------|---|---|
| 0288 21 | Padlocking system for ACB | ■ | 1 |
| 0288 24 | Padlocking for button | ■ | 1 |
| 0288 26 | Padlocking system for shutters | ■ | 1 |

* MRP - Maximum Retail Price Inclusive of all taxes including GST.
■ Price available on request.

DMX³ Auxiliaries and Accessories

| Cat.Nos | Description | MRP* ₹ / Unit | Pack |
|---------|-------------|------------------|------|
|---------|-------------|------------------|------|

Automation control unit

| | | | |
|---------|----------------------|---|---|
| 4226 81 | Standard unit | ■ | 1 |
| 4226 82 | Advanced unit | ■ | 1 |
| 4226 89 | Communication module | ■ | 1 |



4226 82



0288 64

Equipment For Supply Invertors

| | | | |
|---------|-------------------------------------|---|---|
| 0288 64 | Interlock for DMX ³ 2500 | ■ | 1 |
| 0288 65 | Interlock for DMX ³ 4000 | ■ | 1 |
| 0288 66 | Interlock for DMX ³ 6300 | ■ | 1 |

Cable Interlock

| | | | |
|---------|------------------|---|---|
| 0289 20 | Type 1 (2600 mm) | ■ | 1 |
| 0289 21 | Type 2 (3000 mm) | ■ | 1 |
| 0289 22 | Type 3 (3600 mm) | ■ | 1 |
| 0289 23 | Type 4 (4000 mm) | ■ | 1 |
| 0289 24 | Type 5 (4600 mm) | ■ | 1 |
| 0289 25 | Type 6 (5600 mm) | ■ | 1 |

Accessories

| | | | |
|---------|---|---|---|
| 0288 25 | Rating mis-insertion device | ■ | 1 |
| 0288 23 | Operations counter | ■ | 1 |
| 0288 13 | Inserted / test / Draw-out Contact | ■ | 1 |
| 0288 14 | Contact "ready to close" with charged springs | ■ | 1 |
| 0288 15 | Set of additional signalling contacts | ■ | 1 |
| 0288 16 | Signal Contact for Auxiliaries | ■ | 1 |
| 0288 22 | Door sealing IP 40 | ■ | 1 |
| 0288 79 | Lifting plate | ■ | 1 |

Bold Cat.Nos are products normally available with Legrand (India) Stockists. Cat.Nos that are not bold - delivery within 4 - 8 weeks from the date of order. Bold packing quantity is our mandatory packing. Orders to be placed by Legrand (India) Stockist in multiples of the same.

e-COMMUNICATION ARCHITECTURE

PROTECTION

MEASUREMENT

CONTROL AND SIGNALLING

RESIDENTIAL

DX³ Ph+N MCBs



4086 14 4085 90

EMDX³ energy meters



4120 45 4120 81 4120 91



4062 95 4062 52 0261 36

Auxiliaries and motorised control + I/O interface

COLLECTIVE HOUSING AND SMALL OFFICE BUILDINGS

DX³ MCBs

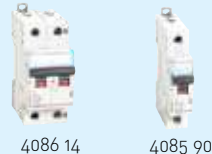

4086 14 4085 90

EMDX³ measuring units



4120 53

EMDX³ energy meters



4120 45 / 4120 81 / 4120 91

Earth Leakage Module with integrated Measurement



4106 57

CX3 EMS signalling and control modules



4149 29 / 4149 30 / 4149 32

CX3 EMS signalling and control modules



4149 31

CX³ + DX³ MCBs



4086 94 4125 56

Cx³ EMS modules:

4149 19 Single phase



4149 20 Three phase



4149 26 Pulse concentrator



Auxiliaries and motorised control + I/O interface



0288 15 0261 44 0261 36

Auxiliaries and motorised controls



0288 15 0261 44

CX3 EMS signalling and control modules



4149 29 / 4149 32

COMMERCIAL AND INDUSTRIAL



4234 28

DPX³ MCCBs



DMX3216L3ED4N

DMX³ ACB

EMDX³ measuring units



4120 53

4120 45 / 4120 91 EMDX³ energy meters



CX³ EMS measuring module



4149 23

Electronic DPX³ with integrated measurement



0283 07

DMX³ with electronic Protection unit

COMMUNICATION

REMOTE

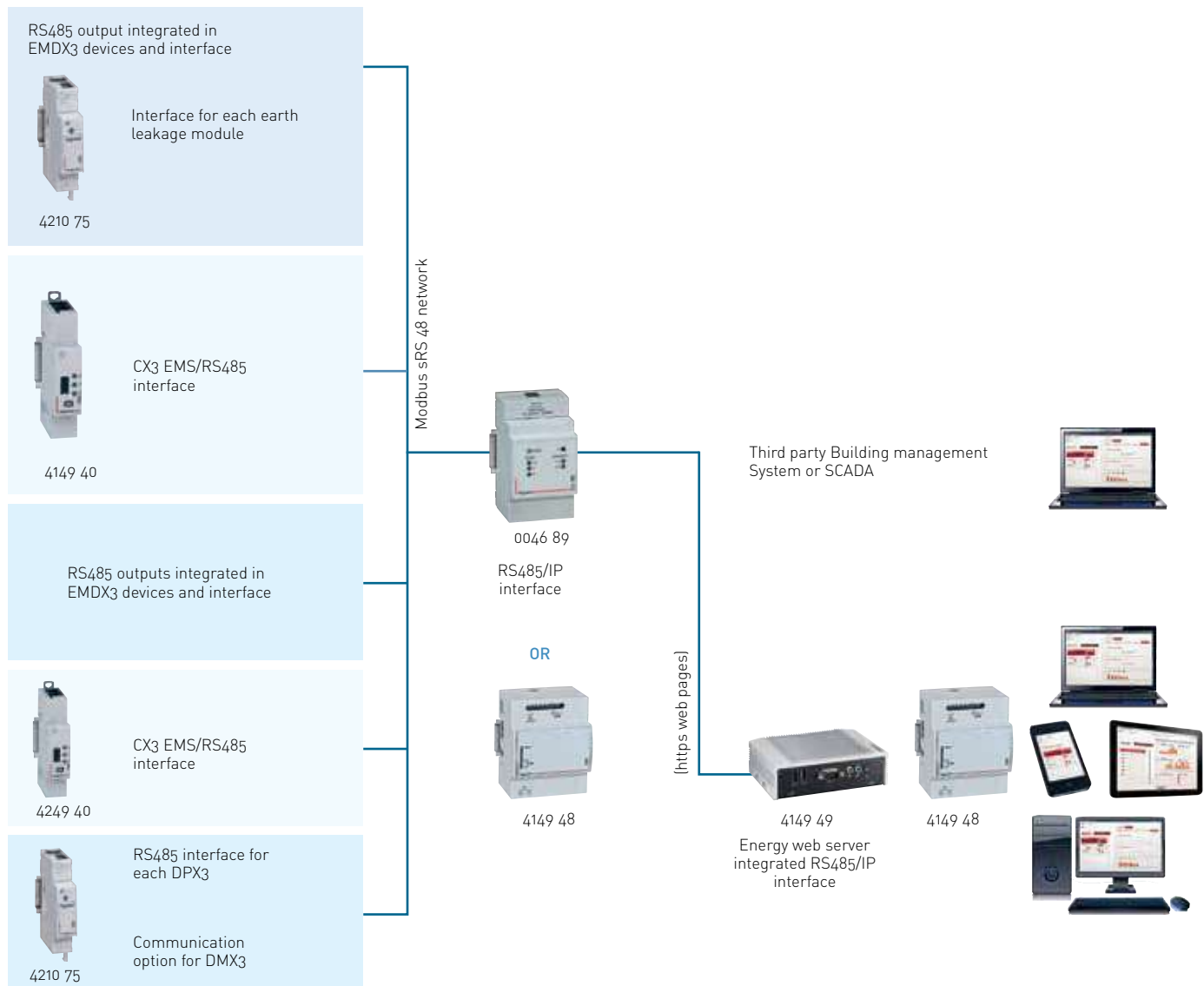

e-Communicating Infrastructure

| Cat.Nos | Description | MRP* ₹ / Unit | Pack |
|---------|-------------|------------------|------|
|---------|-------------|------------------|------|

Power Supervision System

Control, Monitoring And Measurement

Communication Accessories For ACB

| | | | |
|---------|--|-------|----|
| 4149 45 | EMS CX ³ Power Supply 230/12VDC | 12870 | 1 |
| 4149 40 | EMS CX ³ / RS485 Gateway | 15220 | 1 |
| 4149 07 | EMS CX ³ 10 Patch Cords 250MM | 9500 | 10 |
| 4149 08 | EMS CX ³ 10 Patch Cords 500MM | 13690 | 10 |
| 4149 09 | EMS CX ³ 5 Patch Cords 1000MM | 10900 | 5 |
| 4149 10 | EMS CX ³ 5 Patch Cord Connector | 3820 | 5 |

Communication Modules

Signalling and Control Interface

Features

Signalling and control interface between the power supervision system and the **thermal magnetic or electronic circuit breakers**.

Equipped with analogue / digital inputs and relay outputs.

Can handle multiple circuit breakers.

24 inputs for collecting information from the signalling auxiliaries on the DPX³ and DMX³ circuit breakers: auxiliary contact NO position (1 input) or NO+NC position (2 inputs), fault signal (1 input)

6 outputs for: the remote control of the motor driven circuit breakers (2 outputs) and for tripping the circuit breakers (1 output)

Communication is ensured by the Modbus protocol. Address, speed and coding can be modified with

Configuration Kit.

| | | | |
|---------|-------------------------|-------|---|
| 0261 36 | Sign. & Comm. Interface | 38300 | 1 |
|---------|-------------------------|-------|---|

Communication Accessories for MCCB

Features

RS485 communication interface

Potential free contact for circuit breaker tripped status information max. 220 V 0.2 A

| | | | |
|---------|--|-------|---|
| 4210 75 | DPX ³ Communication Interface | 23510 | 1 |
| 4210 83 | Input Voltage 24 V (2MOD) | 6550 | 1 |

* MRP - Maximum Retail Price Inclusive of all taxes including GST.

■ Price available on request.

Red Cat. Nos - New Products

e-Communicating Infrastructure

| Cat.Nos | Description | MRP* ₹ / Unit | Pack |
|---------|-------------|------------------|------|
|---------|-------------|------------------|------|

Communication Accessories For MCB

Features

RS485 communication interface

Potential free contact for circuit breaker tripped status information max. 220 V 0.2 A

Can be connected with DX3 add on Modules (4106 57/58/59)

| | | | |
|---------|--|-------|---|
| 4210 75 | DPX ³ Communication Interface | 23510 | 1 |
|---------|--|-------|---|

Communication Accessories

| | | | |
|---------|---|-------|---|
| 0261 45 | BUS Plug-In Jumpers Kit - 0 to 9 Marking (10 of each) | ■ | 1 |
| 0046 89 | IP Converter RS485/ Ethernet AC | 66590 | 1 |
| 1466 23 | Stabilised Sw Mod Powrsup75 960 | 21944 | 1 |

Energy management multi-support web servers

Allow remote configuration, test, control and visualization, via a web browser on PCs, smartphones, web viewers, tablet computers, of data Converter

Features

In-built IP converter

Power supply: 9 to 28 V= with the help of a single-phase switching mode power supply Cat.No 1467 21 to be ordered separately. With the Legrand Power supervision system, circuit breakers are integrated in a supervision system

You can therefore check the status of the circuit breakers, measure the electrical values and control the circuit breakers remotely.

MODBUS protocol

| | | | |
|---------|--------------------------|--------|---|
| 4149 47 | Mini Energy WS - 10 | 135660 | 1 |
| 4149 48 | Web Server for 32 Meters | 194952 | 1 |
| 4149 49 | Web Server for Unlimited | ■ | 1 |

Bold Cat.Nos are products normally available with Legrand (India) Stockists. Cat.Nos that are not bold - delivery within 4 - 8 weeks from the date of order. Bold packing quantity is our mandatory packing. Orders to be placed by Legrand (India) Stockist in multiples of the same.

DMX-SP

Air Circuit Breakers

For Smart & Reliable Low Voltage Power Distribution



The DMX-SP range of air circuit breakers and trip-free switches offers reliable protection for standard electrical installations. Designed for performance and durability, the range supports current ratings up to 2500A and breaking capacities up to 50kA, ensuring safe and dependable operation across a wide range of applications

Features

- Powered with Advanced MP2.10 and MP4.10 Protection units
- With Integrated LED / LCD display
- Fixed and draw-out configurations
- Available as ACBs and trip-free switches

Benefits

- Rotatable Rear Terminals
- Provides flexible installation options to adapt to different switchboard designs
- Delivers reliable performance in demanding operational conditions
- Lower Power Losses (Energy Efficient)

Scan to know more about the product.



DMX SP 2500 Air Circuit Breakers



- Range – 630 A to 2500 A
- Single Frame Size
- Options of Fixed and Drawout Versions
- Options of Manual & Electrical Versions
- Icu=Ics=Icw(1s)=50 kA
- Compact Dimensions
- Advanced Self Powered Electronic Protection Units
 - MP2.10 and MP4.10
- MP2.10 - Electronic PU with LED Display with LSIG + Neutral O/L + Over Temperature Protection + communication capable
- MP4.10 - Electronic PU with LSIG + Neutral O/L + Over Temperature Protection + LCD Display with Current Metering + 20 Trip History + 20 Alarms + Logical Selectivity
- Configurable LSING protection + communication capable
- Long time delay protection against overloads I_r from 0.2 to 1 x I_n (Step 1A) – OFF
- Long delay protection operation time t_r = 40 ms + 30 s (step 40 ms)
- Short time delay protection against short circuits I_{sd} from 1.5I_r to 10 I_r – OFF (step 1A)
- Short time delay protection operation time (t=k, I₂t=k) t_{sd} = 40 ms + 1 s (step 40 ms)
- Instantaneous protection against very high short circuits I_i from 2 to 15 I_n – OFF (step 1A)
- Earth fault current I_g from 0.2 x I_n – OFF (step 0.1I_n)
- Time delay on earth fault tripping (t=k, I₂t=k) I_g from 80 ms + 1s (step 40 ms)
- Neutral protection I_N = 50% – 100% – 150% – 200% – OFF
- In Built Temperature Protection
- Rotatable Terminals for Horizontal/Vertical Orientation⁽¹⁾
- Fast Operation
- Options to install various safety interlock
- Switchable Thermal Memory

| DMXSP | 1 | 08 | N | 4 | E | D | 2N |
|-------------|---------------|--|--------|--------------------|---|----------------------|---|
| ↓ | ↓ | ↓ | ↓ | ↓ | ↓ | ↓ | ↓ |
| CB Series | Frame | Rating | BC | No. of Poles | Type of Spring Charging | Type of Mechanism | Type of Release |
| DMXS=DMX SP | 1=DMX SP 2500 | 06=630A 08=800A 10=1000A 12=1250A 16=1600A 20=2000A 25=2500A | N=50kA | 3=3Pole 4=4Pole | M=Manual Type E=Electrical with 240V AC ECD+CC & 240V AC S/T | F=Fixed D=Drawout | 00=Trip Free 2N=MP2.10 LSIG 4N= MP4.10 LSIG |

| Type and frame size | Rated Current (A) | 3P | | | 4P | | |
|---------------------|-------------------|---------|-------------|------|---------|-------------|------|
| | | Cat.Nos | MRP*/₹/Unit | Pack | Cat.Nos | MRP*/₹/Unit | Pack |

Manual Fixed Version With MP2.10 PU

| | | | | | | | |
|----------------------------|--------|---------------|--------|---|---------------|--------|---|
| DMX-SP- N 2500 Icu 50KA | 630 A | DMXS106N3MF2N | 196330 | 1 | DMXS106N4MF2N | 256940 | 1 |
| | 800 A | DMXS108N3MF2N | 196330 | 1 | DMXS108N4MF2N | 256940 | 1 |
| | 1000 A | DMXS110N3MF2N | 207350 | 1 | DMXS110N4MF2N | 273480 | 1 |
| | 1250 A | DMXS112N3MF2N | 237660 | 1 | DMXS112N4MF2N | 312040 | 1 |
| | 1600 A | DMXS116N3MF2N | 269190 | 1 | DMXS116N4MF2N | 339490 | 1 |
| | 2000 A | DMXS120N3MF2N | 314850 | 1 | DMXS120N4MF2N | 399390 | 1 |
| | 2500 A | DMXS125N3MF2N | 386460 | 1 | DMXS125N4MF2N | 442310 | 1 |

Manual Drawout Version With MP 2.10 PU

| | | | | | | | |
|---------------------------------------|--------|---------------|--------|---|---------------|--------|---|
| DMX-SP- N 2500 Icu 50KA Frame 1 | 630 A | DMXS106N3MD2N | 240410 | 1 | DMXS106N4MD2N | 301010 | 1 |
| | 800 A | DMXS108N3MD2N | 240410 | 1 | DMXS108N4MD2N | 301010 | 1 |
| | 1000 A | DMXS110N3MD2N | 251440 | 1 | DMXS110N4MD2N | 317550 | 1 |
| | 1250 A | DMXS112N3MD2N | 281730 | 1 | DMXS112N4MD2N | 356120 | 1 |
| | 1600 A | DMXS116N3MD2N | 312440 | 1 | DMXS116N4MD2N | 382740 | 1 |
| | 2000 A | DMXS120N3MD2N | 377350 | 1 | DMXS120N4MD2N | 440640 | 1 |
| | 2500 A | DMXS125N3MD2N | 433000 | 1 | DMXS125N4MD2N | 507470 | 1 |

*MRP - Maximum Retail Price Inclusive of all taxes including GST.
⁽¹⁾Built in bothside rotatable terminals up-to 1600A as a standard offer.

Bold Cat.Nos are products normally available with Legrand (India) Stockists.
 Cat.Nos that are not bold - delivery within 4 - 8 weeks from the date of order.
 Bold packing quantity is our mandatory packing. Orders to be placed by Legrand (India) Stockist in multiples of the same.

DMX SP 2500

Air Circuit Breakers

| Type and frame size | Rated Current (A) | 3P | | | 4P | | |
|---------------------|-------------------|---------|-------------|------|---------|-------------|------|
| | | Cat.Nos | MRP*/₹/Unit | Pack | Cat.Nos | MRP*/₹/Unit | Pack |

Electrical Fixed Version With MP2.10 PU With 240V AC, ECD+CC & 240V AC S/T

| | | | | | | | |
|----------------------------|--------|---------------|--------|---|---------------|--------|---|
| DMX-SP- N 2500 Icu 50KA | 630 A | DMXS106N3EF2N | 261240 | 1 | DMXS106N4EF2N | 321850 | 1 |
| | 800 A | DMXS108N3EF2N | 261240 | 1 | DMXS108N4EF2N | 321850 | 1 |
| | 1000 A | DMXS110N3EF2N | 272260 | 1 | DMXS110N4EF2N | 338380 | 1 |
| | 1250 A | DMXS112N3EF2N | 302560 | 1 | DMXS112N4EF2N | 376940 | 1 |
| | 1600 A | DMXS116N3EF2N | 334080 | 1 | DMXS116N4EF2N | 404390 | 1 |
| | 2000 A | DMXS120N3EF2N | 379750 | 1 | DMXS120N4EF2N | 464300 | 1 |
| | 2500 A | DMXS125N3EF2N | 451360 | 1 | DMXS125N4EF2N | 507200 | 1 |

Electrical Drawout Version With MP 2.10 PU With 240V AC, ECD+CC & 240V AC S/T

| | | | | | | | |
|----------------------------|--------|---------------|--------|---|---------------|--------|---|
| DMX-SP- N 2500 Icu 50KA | 630 A | DMXS106N3ED2N | 305310 | 1 | DMXS106N4ED2N | 365910 | 1 |
| | 800 A | DMXS108N3ED2N | 305310 | 1 | DMXS108N4ED2N | 365910 | 1 |
| | 1000 A | DMXS110N3ED2N | 316350 | 1 | DMXS110N4ED2N | 382450 | 1 |
| | 1250 A | DMXS112N3ED2N | 346640 | 1 | DMXS112N4ED2N | 421010 | 1 |
| | 1600 A | DMXS116N3ED2N | 377350 | 1 | DMXS116N4ED2N | 447630 | 1 |
| | 2000 A | DMXS120N3ED2N | 442240 | 1 | DMXS120N4ED2N | 505540 | 1 |
| | 2500 A | DMXS125N3ED2N | 497910 | 1 | DMXS125N4ED2N | 572360 | 1 |

Manual Fixed Version With MP4.10 PU

| | | | | | | | |
|----------------------------|--------|---------------|--------|---|---------------|--------|---|
| DMX-SP- N 2500 Icu 50KA | 630 A | DMXS106N3MF4N | 212420 | 1 | DMXS106N4MF4N | 278020 | 1 |
| | 800 A | DMXS108N3MF4N | 212420 | 1 | DMXS108N4MF4N | 278020 | 1 |
| | 1000 A | DMXS110N3MF4N | 224350 | 1 | DMXS110N4MF4N | 295900 | 1 |
| | 1250 A | DMXS112N3MF4N | 257140 | 1 | DMXS112N4MF4N | 344860 | 1 |
| | 1600 A | DMXS116N3MF4N | 297500 | 1 | DMXS116N4MF4N | 375200 | 1 |
| | 2000 A | DMXS120N3MF4N | 347960 | 1 | DMXS120N4MF4N | 432130 | 1 |
| | 2500 A | DMXS125N3MF4N | 418140 | 1 | DMXS125N4MF4N | 478560 | 1 |



DMXS116N3MF4N

Manual Drawout Version With MP 4.10 PU

| | | | | | | | |
|----------------------------|--------|---------------|--------|---|---------------|--------|---|
| DMX-SP- N 2500 Icu 50KA | 630 A | DMXS106N3MD4N | 244940 | 1 | DMXS106N4MD4N | 325680 | 1 |
| | 800 A | DMXS108N3MD4N | 244940 | 1 | DMXS108N4MD4N | 325680 | 1 |
| | 1000 A | DMXS110N3MD4N | 256180 | 1 | DMXS110N4MD4N | 343570 | 1 |
| | 1250 A | DMXS112N3MD4N | 287040 | 1 | DMXS112N4MD4N | 393560 | 1 |
| | 1600 A | DMXS116N3MD4N | 322670 | 1 | DMXS116N4MD4N | 422990 | 1 |
| | 2000 A | DMXS120N3MD4N | 389670 | 1 | DMXS120N4MD4N | 476760 | 1 |
| | 2500 A | DMXS125N3MD4N | 441170 | 1 | DMXS125N4MD4N | 549070 | 1 |

Electrical Fixed Version With MP4.10 PU With 240V AC, ECD+CC & 240V AC S/T

| | | | | | | | |
|----------------------------|--------|---------------|--------|---|---------------|--------|---|
| DMX-SP- N 2500 Icu 50KA | 630 A | DMXS106N3EF4N | 282660 | 1 | DMXS106N4EF4N | 348230 | 1 |
| | 800 A | DMXS108N3EF4N | 282660 | 1 | DMXS108N4EF4N | 348230 | 1 |
| | 1000 A | DMXS110N3EF4N | 294560 | 1 | DMXS110N4EF4N | 366110 | 1 |
| | 1250 A | DMXS112N3EF4N | 327360 | 1 | DMXS112N4EF4N | 416580 | 1 |
| | 1600 A | DMXS116N3EF4N | 369220 | 1 | DMXS116N4EF4N | 446920 | 1 |
| | 2000 A | DMXS120N3EF4N | 419690 | 1 | DMXS120N4EF4N | 513110 | 1 |
| | 2500 A | DMXS125N3EF4N | 488360 | 1 | DMXS125N4EF4N | 548780 | 1 |

* MRP - Maximum Retail Price Inclusive of all taxes including GST.

Bold Cat.Nos are products normally available with Legrand (India) Stockists. Cat.Nos that are not bold - delivery within 4 - 8 weeks from the date of order. Bold packing quantity is our mandatory packing. Orders to be placed by Legrand (India) Stockist in multiples of the same.

DMX SP 2500

Air Circuit Breakers

| Type and frame size | Rated Current (A) | 3P | | | 4P | | |
|---------------------|-------------------|---------|-------------|------|---------|-------------|------|
| | | Cat.Nos | MRP*/₹/Unit | Pack | Cat.Nos | MRP*/₹/Unit | Pack |

Electrical Drawout Version With MP 4.10 PU With 240V AC, ECD+CC & 240V AC S/T

| | | | | | | | |
|----------------------------|--------|---------------|--------|---|---------------|--------|---|
| DMX-SP- N 2500 Icu 50KA | 630 A | DMXS106N3ED4N | 330340 | 1 | DMXS106N4ED4N | 395900 | 1 |
| | 800 A | DMXS108N3ED4N | 330340 | 1 | DMXS108N4ED4N | 395900 | 1 |
| | 1000 A | DMXS110N3ED4N | 342280 | 1 | DMXS110N4ED4N | 413810 | 1 |
| | 1250 A | DMXS112N3ED4N | 375060 | 1 | DMXS112N4ED4N | 465280 | 1 |
| | 1600 A | DMXS116N3ED4N | 417020 | 1 | DMXS116N4ED4N | 494710 | 1 |
| | 2000 A | DMXS120N3ED4N | 488760 | 1 | DMXS120N4ED4N | 558710 | 1 |
| | 2500 A | DMXS125N3ED4N | 538720 | 1 | DMXS125N4ED4N | 619280 | 1 |

Switch Disconnector (Trip Free Switches) From 630 To 2500A Manual Fixed Version

| | | | | | | | |
|---------------------------|--------|---------------|--------|---|---------------|--------|---|
| DMX ³ - I 2500 | 630 A | DMXS106S3MF00 | 154260 | 1 | DMXS106S4MF00 | 214870 | 1 |
| | 800 A | DMXS108S3MF00 | 154260 | 1 | DMXS108S4MF00 | 214870 | 1 |
| | 1000 A | DMXS110S3MF00 | 165270 | 1 | DMXS110S4MF00 | 231400 | 1 |
| | 1250 A | DMXS112S3MF00 | 195570 | 1 | DMXS112S4MF00 | 269960 | 1 |
| | 1600 A | DMXS116S3MF00 | 227100 | 1 | DMXS116S4MF00 | 297410 | 1 |
| | 2000 A | DMXS120S3MF00 | 271990 | 1 | DMXS120S4MF00 | 357310 | 1 |
| | 2500 A | DMXS125S3MF00 | 344380 | 1 | DMXS125S4MF00 | 400220 | 1 |

Manual Drawout Version

| | | | | | | | |
|---------------------------|--------|---------------|--------|---|---------------|--------|---|
| DMX ³ - I 2500 | 630 A | DMXS106S3MD00 | 198320 | 1 | DMXS106S4MD00 | 258920 | 1 |
| | 800 A | DMXS108S3MD00 | 198320 | 1 | DMXS108S4MD00 | 258920 | 1 |
| | 1000 A | DMXS110S3MD00 | 209350 | 1 | DMXS110S4MD00 | 275460 | 1 |
| | 1250 A | DMXS112S3MD00 | 239660 | 1 | DMXS112S4MD00 | 314030 | 1 |
| | 1600 A | DMXS116S3MD00 | 270360 | 1 | DMXS116S4MD00 | 340650 | 1 |
| | 2000 A | DMXS120S3MD00 | 335260 | 1 | DMXS120S4MD00 | 398560 | 1 |
| | 2500 A | DMXS125S3MD00 | 390920 | 1 | DMXS125S4MD00 | 465380 | 1 |

* MRP - Maximum Retail Price Inclusive of all taxes including GST.
 Note - 1. For EF and ED0 versions of Switch-disconnectors, please contact Sales office.
 For Voltages other than 220 - 250 V AC and DC, please order MF/MDO ACB and the required Voltage accessories

Bold Cat.Nos are products normally available with Legrand (India) Stockists. Cat.Nos that are not bold - delivery within 4 - 8 weeks from the date of order. Bold packing quantity is our mandatory packing. Orders to be placed by Legrand (India) Stockist in multiples of the same.

DMX SP 2500

Electronic Protection Units

| Cat.Nos | Description | MRP* ₹ / Unit | Pack |
|---------|---|------------------|------|
| 0283 00 | MP2.10 Protection Unit with rotating encoder for Adjustmen of Ir, tr, isd, tsd, li, lg and tg Possibility to enable/disable protections With Current Measurement and LCD display protection conditions Fault signaling and log | 42090 | 1 |
| 0283 02 | MP4.10 Protection Unit with rotating encoder for Adjustmen of Ir, tr, isd, tsd, li, lg and tg Possibility to enable/disable protections With Current Measurement and LCD display protection conditions Fault signaling and log | 52480 | 1 |

Auxillaries Accessories

Motor Operator

| | | | |
|---------|--------------------------------|-------|---|
| 0281 20 | Motor operator 24V AC/DC DMX S | 48510 | 1 |
| 0281 21 | Motor operator 48V AC/DC DMX S | 48510 | 1 |
| 0281 22 | Motor operator 110-130V AC/DC | 48510 | 1 |
| 0281 23 | Motor operator 220-250V AC/DC | 48510 | 1 |
| 0281 24 | Motor operator 415V - 440V ac | 48510 | 1 |

Closing Coil

| | | | |
|---------|--------------------------------|------|---|
| 0281 26 | Closing coil 24V AC/DC DMX SP | 8170 | 1 |
| 0281 27 | Closing coil 48V AC/DC DMX SP | 8170 | 1 |
| 0281 28 | Closing coil 110-130V AC/DC DM | 8170 | 1 |
| 0281 29 | Closing coil 220-250V AC/DC DM | 8170 | 1 |
| 0281 30 | Closing coi 415-440V AC DMX S | 8170 | 1 |

Shunt Release

| | | | |
|---------|-------------------------------|------|---|
| 0281 31 | Shunt trip 24V AC/DC DMX SP | 8170 | 1 |
| 0281 32 | Shunt trip 48V AC/DC DMX SP | 8170 | 1 |
| 0281 33 | Shunt trip 110-130V AC/DC DMX | 8170 | 1 |
| 0281 34 | Shunt trip 220-250V AC/DC DMX | 8170 | 1 |
| 0281 35 | Shunt trip 415-440V AC DMX SP | 8170 | 1 |

Undervoltage Release

| | | | |
|---------|--------------------------------|-------|---|
| 0281 36 | Undervoltage release 24V AC/DC | 11040 | 1 |
| 0281 37 | Undervoltage release 48V AC/DC | 11040 | 1 |
| 0281 38 | Undervoltage release 110-130V | 11040 | 1 |
| 0281 39 | Undervoltage release 220-250V | 11040 | 1 |
| 0281 40 | Undervoltage release 415-440V | 11040 | 1 |

■ Price available on request.

* MRP - Maximum Retail Price Inclusive of all taxes including GST.

Red Cat. Nos - New Products

DMX SP 2500

Auxillaries Accessories

| Cat.Nos | Description | MRP* ₹ / Unit | Pack |
|---------|-------------|------------------|------|
|---------|-------------|------------------|------|

Time Delay Module For Undervoltage Release

| | | | |
|---------|----------------------------------|------|---|
| 0288 62 | Undervolt Rel T Delay 110V AC/DC | ■ | 1 |
| 0288 63 | Undervolt Rel T Delay 230V AC/DC | 9140 | 1 |

Mechanical Accessories

Phase Barriers / Insulated Shields

| | | | |
|---------|--------------------------------|------|---|
| 6696 00 | Fix Version 3P DMX SP | ■ | 1 |
| 6696 01 | Fix Version 4P DMX SP | ■ | 1 |
| 6696 02 | Insulation shields Draw-out Ve | 2810 | 1 |
| 6696 03 | Insulation shields Draw-out Ve | 3750 | 1 |

Key Lock Open & Drawout Position

| | | | |
|---------|---|------|---|
| 0281 91 | Key Lock In Open & D/O Posit | ■ | 1 |
| 4238 80 | Key barrel and flat key with random mapping | ■ | 1 |
| 4238 81 | Key barrel and flat key with fixed mapping | ■ | 1 |
| 4238 82 | Key barrel and flat key with fixed mapping | ■ | 1 |
| 4238 83 | Key barrel and star key with random mapping | ■ | 1 |
| 0281 84 | Door lock for both right&left | 6840 | 1 |
| 0281 87 | Safety button for test positio | 3160 | 1 |

Terminals

| | | | |
|---------|---|-------|---|
| 0288 84 | Real terminals - flat connection | 26720 | 1 |
| 0288 82 | Real terminals - vertical connection | 29690 | 1 |
| 0288 85 | Real terminals - flat connection | 34730 | 1 |
| 0288 83 | Real terminals - vertical connection | 40070 | 1 |
| 0288 96 | Real terminals - vertical or horizontal | 16150 | 1 |
| 0288 97 | Real terminals - vertical or horizontal | 21540 | 1 |

Additional Accessories

| | | | |
|---------|---------------------------------|-------|---|
| 0281 88 | Mechanical counter DMX SP | 5260 | 1 |
| 0281 77 | Padlock for button DMX SP | 2090 | 1 |
| 6696 20 | External Neutral DMX-SP 2500 M | 23110 | 1 |
| 0281 73 | Signalling contact inserted-tes | 4120 | 1 |
| 0281 74 | AUX ready to close-charged spr | 4210 | 1 |
| 0281 75 | Module with 6 aux contacts DMX | 31560 | 1 |
| 0281 90 | Mech Interlock two device | 16870 | 1 |

Bold Cat.Nos are products normally available with Legrand (India) Stockists. Cat.Nos that are not bold - delivery within 4 - 8 weeks from the date of order. Bold packing quantity is our mandatory packing. Orders to be placed by Legrand (India) Stockist in multiples of the same.

NEW!

1000V Solution

Smart Protection Renewable Energy installations

DMX³ ACBs and DPX³ MCCBs are engineered to deliver reliable 1000V AC protection for critical applications across renewable energy, wind power, and rail infrastructure. Designed for high-performance environments, they combine robust protection, compact integration, and intelligent monitoring to support efficient and future-ready power distribution systems.

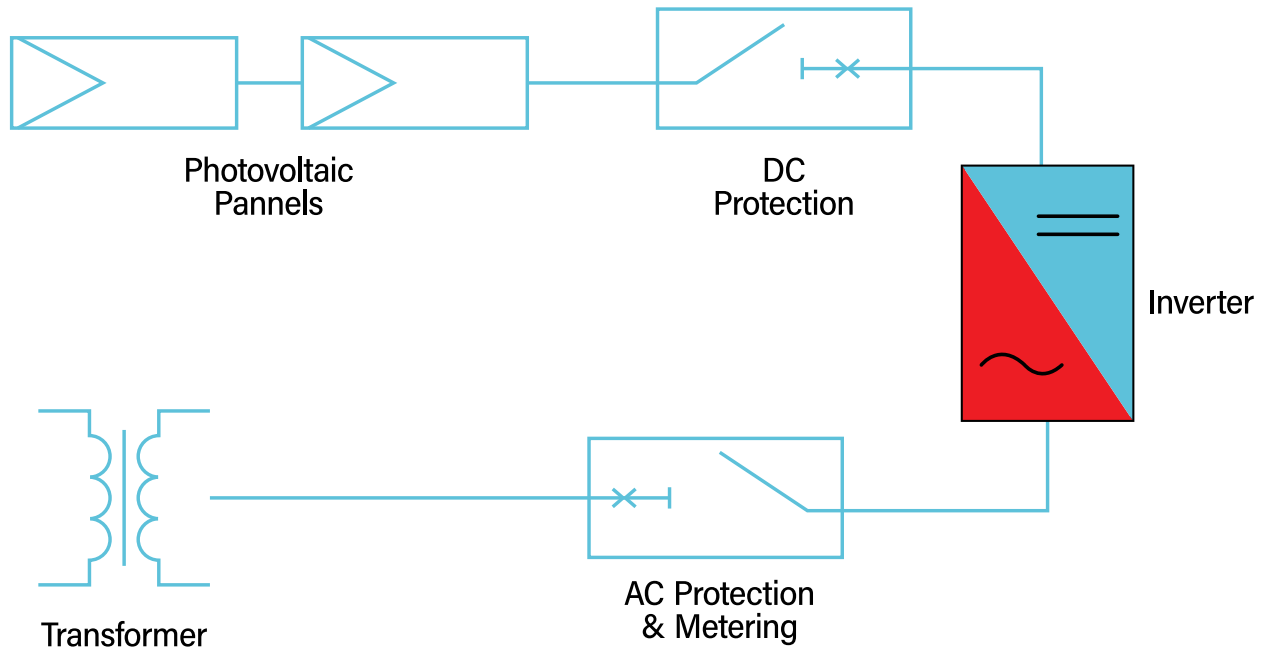

DMX³
1000V ACB



DPX³
1000V MCCB

Application Areas

Solar Power Plants



1000V DMX³ ACBs provide reliable protection at main distribution and grid interface points, while DPX³ MCCBs ensure efficient feeder and circuit protection across inverter outputs and distribution networks in large-scale photovoltaic installations.

Wind Energy Systems

Scan to know more about the product.



Legrand 1000V DMX³ ACBs deliver robust protection for turbine switchboards and main power distribution, while DPX³ MCCBs support dependable feeder-level protection within nacelles and wind farm electrical systems.

NEW!

DPX³ MCCBs

For Smart & Reliable
Low Voltage
Power Distribution



Key Highlights

- Thermal-magnetic and New Electronics protection trip unit- S1 & S10
- Zone Selective Interlocking with USB port and inbuilt LCD screen
- Customizable protection settings to match specific project power distribution requirements
- High breaking capacity up to 100 kA for dependable fault interruption
- Bluetooth connectivity for smartphone-based configuration and monitoring
- Connectivity with EMS and supervision systems for smarter energy management



DPX³ 630 and 1600

S1 and S10 protection units



DPX³630

DPX³1600

Scan to know more about the product.



DPX³ MCCB
DPX³ MCCB 125/160/250 HP

| Category | Type | Rated Current (A) | 3P | | | 4P | | |
|----------|------|-------------------|---------|-------------|------|---------|-------------|------|
| | | | Cat.Nos | MRP*/₹/Unit | Pack | Cat.Nos | MRP*/₹/Unit | Pack |

Thermal Magnetic release -Fixed version

| | | | | | | | | | |
|------------------------|------------------------|------------------------|--------|--------|--------|--------|--------|-------|---|
| 36 KA | DPX ³ 125HP | 16 | 423600 | 14730 | 1 | 423610 | 18390 | 1 | |
| | | 25 | 423602 | 14730 | 1 | 423612 | 18390 | 1 | |
| | | 40 | 423604 | 14730 | 1 | 423614 | 18390 | 1 | |
| | | 63 | 423606 | 14730 | 1 | 423616 | 18390 | 1 | |
| | | 80 | 423607 | 14730 | 1 | 423617 | 18390 | 1 | |
| | | 100 | 423608 | 14730 | 1 | 423618 | 18390 | 1 | |
| | | 125 | 423609 | 17270 | 1 | 423619 | 22540 | 1 | |
| | DPX ³ 160HP | 160 | 423720 | 21480 | 1 | 423721 | 25290 | 1 | |
| | DPX ³ 250HP | 200 | 423011 | 38070 | 1 | 423026 | 48130 | 1 | |
| | | 250 | 423012 | 42230 | 1 | 423027 | 51530 | 1 | |
| | 50 KA | DPX ³ 125HP | 16 | 423640 | 19620 | 1 | 423650 | 24730 | 1 |
| | | | 25 | 423642 | 19620 | 1 | 423652 | 24730 | 1 |
| | | | 40 | 423644 | 19620 | 1 | 423654 | 24730 | 1 |
| | | | 63 | 423646 | 19620 | 1 | 423656 | 24730 | 1 |
| 80 | | | 423647 | 19620 | 1 | 423657 | 24730 | 1 | |
| 100 | | | 423648 | 19620 | 1 | 423658 | 24730 | 1 | |
| 125 | | | 423649 | 25710 | 1 | 423659 | 29640 | 1 | |
| DPX ³ 160HP | | 160 | 423725 | 27940 | 1 | 423726 | 32500 | 1 | |
| DPX ³ 250HP | | 200 | 423071 | 46120 | 1 | 423086 | 58260 | 1 | |
| | | 250 | 423072 | 48680 | 1 | 423087 | 60610 | 1 | |
| DPX ³ 250HP | 200 | 423131 | 62160 | 1 | 423146 | 76480 | 1 | | |
| | 250 | 423132 | 66060 | 1 | 423147 | 79610 | 1 | | |

Thermal magnetic release with Electronic earth leakage module - Fixed version

| | | | | | | | | |
|-------|------------------------|-----|---|---|---|--------|-------|---|
| 36 KA | DPX ³ 125HP | 16 | ■ | ■ | ■ | 423630 | 68920 | 1 |
| | | 25 | ■ | ■ | ■ | 423632 | 68920 | 1 |
| | | 40 | ■ | ■ | ■ | 423634 | 68920 | 1 |
| | | 63 | ■ | ■ | ■ | 423636 | 68920 | 1 |
| | | 80 | ■ | ■ | ■ | 423637 | 68920 | 1 |
| | | 100 | ■ | ■ | ■ | 423638 | 68920 | 1 |
| | | 125 | ■ | ■ | ■ | 423639 | 69290 | 1 |
| | DPX ³ 160HP | 160 | ■ | ■ | ■ | 423723 | 79550 | 1 |
| | DPX ³ 250HP | 200 | ■ | ■ | ■ | 423056 | 87110 | 1 |
| | | 250 | ■ | ■ | ■ | 423057 | 93150 | 1 |

■ Price available on request.

* MRP - Maximum Retail Price inclusive of all taxes including GST.

Bold Cat.Nos are products normally available with Legrand (India) Stockists. Cat.Nos that are not bold - delivery within 4 - 8 weeks from the date of order. Bold packing quantity is our mandatory packing. Orders to be placed by Legrand (India) Stockist in multiples of the same.

DPX³ MCCB

DPX³ MCCB 125/160/250 HP

| Category | Type | Rated Current (A) | 3P | | | 4P | | |
|--|------------------------|-------------------|---------|-------------|------|---------|-------------|------|
| | | | Cat.Nos | MRP*/₹/Unit | Pack | Cat.Nos | MRP*/₹/Unit | Pack |
| Thermal magnetic release with Electronic earth leakage module - Fixed version | | | | | | | | |
| 50 KA | DPX ³ 125HP | 16 | ■ | ■ | ■ | 423670 | 77030 | 1 |
| | | 25 | ■ | ■ | ■ | 423672 | 77030 | 1 |
| | | 40 | ■ | ■ | ■ | 423674 | 77030 | 1 |
| | | 63 | ■ | ■ | ■ | 423676 | 77030 | 1 |
| | | 80 | ■ | ■ | ■ | 423677 | 77030 | 1 |
| | | 100 | ■ | ■ | ■ | 423678 | 77030 | 1 |
| | | 125 | ■ | ■ | ■ | 423679 | 85030 | 1 |
| | DPX ³ 160HP | 160 | ■ | ■ | ■ | 423728 | 85460 | 1 |
| | DPX ³ 250HP | 200 | ■ | ■ | ■ | 423116 | 104360 | 1 |
| | | 250 | ■ | ■ | ■ | 423117 | 110880 | 1 |

Accessories of DPX³ 125 HP, 160HP

| Cat.Nos | Description | MRP* ₹ / Unit | Pack | Cat.Nos | Description | MRP* ₹ / Unit | Pack |
|---------|---|------------------|------|---------|---|------------------|------|
| 423810 | DPX ³ 125HP RH DIRECT STD | 1810 | 1 | 421049 | Padlock for locking in "open" position For DPX ³ 160/250 and DPX ³ 125/160/250 HP | ■ | 1 |
| 423811 | DPX ³ 125HP RH DIRECT EMERG | 1970 | 1 | 423876 | CAGE TERMINALS DPX ³ 125 HP(3P) | 11050 | 1 |
| 423812 | DPX ³ 125HP RH VARI DEPTH STD | 2980 | 1 | 423877 | CAGE TERMINALS DPX ³ 125 HP(4P) | 14620 | 1 |
| 423813 | DPX ³ 125HP RH VARI DEPTH EMERG | 3230 | 1 | 423884 | CAGE TERMINALS DPX ³ 125 HP(3P) | ■ | 1 |
| 423805 | DPX ³ 125&250HPKEYLOCK ACC VARI | 3160 | 1 | 423885 | CAGE TERMINALS DPX ³ 125 HP(4P) | ■ | 1 |
| 423806 | AUXILIARY CNT BLOCK 1N/C+1 N/O | 2010 | 1 | 423888 | 3 LINKS SET FOR TP DRX125A EXP | 1000 | 1 |
| 423825 | Plate for mounting and interlocking of 2 DPX ³ 125/160 HP | ■ | 1 | 423889 | 4 LINKS SET FOR FP DRX125A EXP | 1350 | 1 |
| 423827 | Interlocking mechanism for 2 fixed DPX ³ 125/160/250 HP MCCBs | ■ | 1 | 423891 | DPX ³ 125HP REAR TERMINALS 4P | 6020 | 1 |
| 423828 | Interlocking mechanism for 2 fixed DPX ³ 125/160/250 HP MCCBs with electronic module | ■ | 1 | 423892 | DPX ³ 125HP REAR TERMINALS 4P | 8070 | 1 |
| 423834 | Set of 2 insulated shields for DPX ³ 125/160/250 HP 3P | ■ | 1 | 423893 | SHIELDS FOR FRONT TERMINAL(HIG) | 4150 | 1 |
| 423835 | Set of 3 insulated shields for DPX ³ 125/160/250 HP 4P | ■ | 1 | 423894 | SHIELDS FOR FRONT TERMINAL(HIG) | 3680 | 1 |

■ Price available on request.

* MRP - Maximum Retail Price Inclusive of all taxes including GST.

Bold Cat.Nos are products normally available with Legrand (India) Stockists. Cat.Nos that are not bold - delivery within 4 - 8 weeks from the date of order. **Bold packing quantity** is our mandatory packing. Orders to be placed by Legrand (India) Stockist in multiples of the same.

DPX³ MCCB

DPX³ 250 HP MCCB with New Electronics S1 Protection Unit

- DPX³ MCCB with electronic S1 (LSI) protection unit
- Configurable Protections with Enable and Disable possibility
 - Ics=100%Icu
 - Protection against Overloads:
 - Ir adjustable from OFF-0.4 to 1 x In
 - tr adjustable- 5s
 - Protection against Short Circuits:
 - Isd adjustable 1.5 to 10Ir
 - tsd - 100ms
 - Breaking Capacity – 36kA, 50kA, 70kA & 100kA

| Category | Type | Rated Current (A) | 3P | | | 4P | | |
|----------|------|-------------------|---------|-------------|------|---------|-------------|------|
| | | | Cat.Nos | MRP*/₹/Unit | Pack | Cat.Nos | MRP*/₹/Unit | Pack |

Electronic S1 (LSI) Protection Unit

| | | | | | | | | |
|--------|------------------------|-----|--------|---|---|--------|---|---|
| 36 KA | DPX ³ 250HP | 40 | 423200 | ■ | 1 | 423205 | ■ | 1 |
| | | 100 | 423201 | ■ | 1 | 423206 | ■ | 1 |
| | | 160 | 423202 | ■ | 1 | 423207 | ■ | 1 |
| | | 250 | 423203 | ■ | 1 | 423208 | ■ | 1 |
| 50 KA | DPX ³ 250HP | 40 | 423220 | ■ | 1 | 423225 | ■ | 1 |
| | | 100 | 423221 | ■ | 1 | 423226 | ■ | 1 |
| | | 160 | 423222 | ■ | 1 | 423227 | ■ | 1 |
| | | 250 | 423223 | ■ | 1 | 423228 | ■ | 1 |
| 70 KA | DPX ³ 250HP | 40 | 423240 | ■ | 1 | 423245 | ■ | 1 |
| | | 100 | 423241 | ■ | 1 | 423246 | ■ | 1 |
| | | 160 | 423242 | ■ | 1 | 423247 | ■ | 1 |
| | | 250 | 423243 | ■ | 1 | 423248 | ■ | 1 |
| 100 KA | DPX ³ 250HP | 40 | 423250 | ■ | 1 | 423255 | ■ | 1 |
| | | 100 | 423251 | ■ | 1 | 423256 | ■ | 1 |
| | | 160 | 423252 | ■ | 1 | 423257 | ■ | 1 |
| | | 250 | 423253 | ■ | 1 | 423258 | ■ | 1 |

Electronic S1 (LSI) Protection Unit with Electronic earth leakage module - Fixed version

| | | | | | | | | |
|-------|------------------------|-----|---|---|---|--------|---|---|
| 36 KA | DPX ³ 250HP | 40 | ■ | ■ | ■ | 423215 | ■ | 1 |
| | | 100 | ■ | ■ | ■ | 423216 | ■ | 1 |
| | | 160 | ■ | ■ | ■ | 423217 | ■ | 1 |
| | | 250 | ■ | ■ | ■ | 423218 | ■ | 1 |
| 50 KA | DPX ³ 250HP | 40 | ■ | ■ | ■ | 423235 | ■ | 1 |
| | | 100 | ■ | ■ | ■ | 423236 | ■ | 1 |
| | | 160 | ■ | ■ | ■ | 423237 | ■ | 1 |
| | | 250 | ■ | ■ | ■ | 423238 | ■ | 1 |

■ Price available on request.

* MRP - Maximum Retail Price Inclusive of all taxes including GST.

Bold Cat.Nos are products normally available with Legrand (India) Stockists. Cat.Nos that are not bold - delivery within 4 - 8 weeks from the date of order. Bold packing quantity is our mandatory packing. Orders to be placed by Legrand (India) Stockist in multiples of the same.

DPX³ MCCB

DPX³ 250 HP MCCB with New Electronics S10 Protection Unit

- DPX³ MCCB with electronic S10 (LSIg) & energy metering protection unit
- Configurable Protections with Enable and Disable possibility
 - Ics=100%Icu
 - Protection against Overloads:
 - Ir adjustable from OFF-0.2 to 1 x In
 - tr adjustable from 3 to 30s
 - Protection against Short Circuits:
 - Isd adjustable from OFF-1.5 to 10 x Ir
 - tsd adjustable from 0 to 0.5s
 - Inbuilt Instantaneous Protection: - li – Fixed and 2 to 15x In through PCS
 - Protection against Ground Fault:
 - Ig adjustable from 0.2 to 1 In & OFF
 - tg adjustable from 0.80ms to 1s
 - Protection against Neutral Fault: OFF-50% -100% -150% -200%
 - Breaking Capacity – 36kA, 50kA, 70kA & 100kA
 - Integrated energy metering with accuracy class 1
 - Measure for currents, voltage, frequency, power, energy, THD and Individual harmonics
 - Internal Battery with battery measure function
 - Communication ready
 - Logical Selectivity Ready (Zone Selective Interlocking)
 - In Built USB Port for Software Diagnosis
 - Switchable Thermal Memory
 - Suitable for Isolation

| Category | Type | Rated Current (A) | 3P | | | 4P | | |
|----------|------|-------------------|---------|-------------|------|---------|-------------|------|
| | | | Cat.Nos | MRP*/₹/Unit | Pack | Cat.Nos | MRP*/₹/Unit | Pack |

Electronic S10 (LSIg) Protection Unit

| | | | | | | | | |
|--------|---------------------------|-----|--------|---|---|--------|---|---|
| 36 KA | DPX ³ 250HP | 40 | 423400 | ■ | 1 | 423405 | ■ | 1 |
| | | 100 | 423401 | ■ | 1 | 423406 | ■ | 1 |
| | | 160 | 423402 | ■ | 1 | 423407 | ■ | 1 |
| | | 250 | 423403 | ■ | 1 | 423408 | ■ | 1 |
| 50 KA | DPX ³ 250HP | 40 | 423420 | ■ | 1 | 423425 | ■ | 1 |
| | | 100 | 423421 | ■ | 1 | 423426 | ■ | 1 |
| | | 160 | 423422 | ■ | 1 | 423427 | ■ | 1 |
| | | 250 | 423423 | ■ | 1 | 423428 | ■ | 1 |
| 70 KA | DPX ³ 250HP | 40 | 423440 | ■ | 1 | 423445 | ■ | 1 |
| | | 100 | 423441 | ■ | 1 | 423446 | ■ | 1 |
| | | 160 | 423442 | ■ | 1 | 423447 | ■ | 1 |
| | | 250 | 423443 | ■ | 1 | 423448 | ■ | 1 |
| 100 KA | DPX ³ 250HP | 40 | 423450 | ■ | 1 | 423455 | ■ | 1 |
| | | 100 | 423451 | ■ | 1 | 423456 | ■ | 1 |
| | | 160 | 423452 | ■ | 1 | 423457 | ■ | 1 |
| | | 250 | 423453 | ■ | 1 | 423458 | ■ | 1 |

Electronic S10 (LSIg) Protection Unit with Measure

| | | | | | | | | |
|--------|---------------------------|-----|--------|---|---|--------|---|---|
| 36 KA | DPX ³ 250HP | 40 | 423460 | ■ | 1 | 423465 | ■ | 1 |
| | | 100 | 423461 | ■ | 1 | 423466 | ■ | 1 |
| | | 160 | 423462 | ■ | 1 | 423467 | ■ | 1 |
| | | 250 | 423463 | ■ | 1 | 423468 | ■ | 1 |
| 50 KA | DPX ³ 250HP | 40 | 423480 | ■ | 1 | 423485 | ■ | 1 |
| | | 100 | 423481 | ■ | 1 | 423486 | ■ | 1 |
| | | 160 | 423482 | ■ | 1 | 423487 | ■ | 1 |
| | | 250 | 423483 | ■ | 1 | 423488 | ■ | 1 |
| 70 KA | DPX ³ 250HP | 40 | 423500 | ■ | 1 | 423505 | ■ | 1 |
| | | 100 | 423501 | ■ | 1 | 423506 | ■ | 1 |
| | | 160 | 423502 | ■ | 1 | 423507 | ■ | 1 |
| | | 250 | 423503 | ■ | 1 | 423508 | ■ | 1 |
| 100 KA | DPX ³ 250HP | 40 | 423510 | ■ | 1 | 423515 | ■ | 1 |
| | | 100 | 423511 | ■ | 1 | 423516 | ■ | 1 |
| | | 160 | 423512 | ■ | 1 | 423517 | ■ | 1 |
| | | 250 | 423513 | ■ | 1 | 423518 | ■ | 1 |

■ Price available on request.

* MRP - Maximum Retail Price Inclusive of all taxes including GST.

Bold Cat.Nos are products normally available with Legrand (India) Stockists. Cat.Nos that are not bold - delivery within 4 - 8 weeks from the date of order. Bold packing quantity is our mandatory packing. Orders to be placed by Legrand (India) Stockist in multiples of the same.

DPX³ MCCB

DPX³ 250 HP MCCB with New Electronics S10 Protection Unit

| Category | Type | Rated Current (A) | 3P | | | 4P | | |
|---|------------------------|-------------------|---------|-------------|------|---------|-------------|------|
| | | | Cat.Nos | MRP*/₹/Unit | Pack | Cat.Nos | MRP*/₹/Unit | Pack |
| Electronic S10 (LSIg) Protection Unit with Electronic earth leakage module - Fixed version | | | | | | | | |
| 36 KA | DPX ³ 250HP | 40 | ■ | ■ | ■ | 423475 | ■ | 1 |
| | | 100 | ■ | ■ | ■ | 423476 | ■ | 1 |
| | | 160 | ■ | ■ | ■ | 423477 | ■ | 1 |
| | | 250 | ■ | ■ | ■ | 423478 | ■ | 1 |
| 50 KA | DPX ³ 250HP | 40 | ■ | ■ | ■ | 423495 | ■ | 1 |
| | | 100 | ■ | ■ | ■ | 423496 | ■ | 1 |
| | | 160 | ■ | ■ | ■ | 423497 | ■ | 1 |
| | | 250 | ■ | ■ | ■ | 423498 | ■ | 1 |

| Cat.Nos | Description | MRP* ₹ / Unit | Pack |
|---------|-------------|------------------|------|
|---------|-------------|------------------|------|

Accessories of DPX³ 250 HP

| | | | |
|--------|---|------|---|
| 423814 | DPX ³ 250HP RH DIRECT STD | 1810 | 1 |
| 423815 | DPX ³ 250HP RH DIRECT EMERG | 1970 | 1 |
| 423816 | DPX ³ 250HP RH VARI DEPTH STD | 2980 | 1 |
| 423817 | DPX ³ 250HP RH VARI DEPTH EMERG | 3230 | 1 |
| 423804 | Locking supports for direct handle | ■ | 1 |
| 423805 | Locking supports for vari-depth handle | ■ | 1 |
| 423806 | 1 N/C + 1 N/O auxiliary contact for rotary handles | ■ | 1 |
| 423840 | Front installation motor operators-24 V AC | ■ | 1 |
| 423841 | Front installation motor operators- 48 V AC | ■ | 1 |
| 423842 | Front installation motor operators- 110 V AC | ■ | 1 |
| 423843 | Front installation motor operators- 230 V AC | ■ | 1 |
| 423845 | Locking support for motor operators Cat.Nos 4 238 40/41/42/43. To be equipped with universal keylocks Cat.No 4 238 80/81/82/83 | ■ | 1 |
| 423846 | Padlock for motor operators Cat.Nos 4 238 40/41/42/43 | ■ | 1 |

| Cat.Nos | Description | MRP* ₹ / Unit | Pack |
|---------|-------------|------------------|------|
|---------|-------------|------------------|------|

Accessories of DPX³ 250 HP

| | | | |
|--------|---|------|---|
| 423834 | Set of 2 insulated shields for DPX3 HP 125/250 3P | ■ | |
| 423835 | Set of 3 insulated shields for DPX3 HP 125/250 4P | ■ | |
| 421049 | Padlock for locking in "open" position for DPX ³ 160/250 and DPX ³ 125/250 HP | ■ | |
| 423830 | DPX ³ 250 HP CAGE TERMINAL FOR | 4460 | 1 |
| 423831 | DPX ³ 250 HP CAGE TERMINAL FOR | 5800 | 1 |
| 423821 | DPX ³ 250HP REAR TERMINALS 3P | 6080 | 1 |
| 423822 | DPX ³ 250HP REAR TERMINALS 4P | 8190 | 1 |
| 625014 | TP SPRDR LINK SET FOR DPX250ER | 1020 | 1 |
| 625018 | FP SPDR LINK SET FOR DPX250ER | 1380 | 1 |
| 421011 | DPX ³ aux cont & fault signals | 1620 | 1 |
| 421012 | DPX ³ SHUNT RELEASE-12VAC/DC | 3600 | 1 |
| 421013 | DPX ³ shu.rel-coil vol.24VAC/DC | 3600 | 1 |
| 421014 | DPX ³ SHUNT RELEASE-48VAC/DC | 3600 | 1 |
| 421015 | DPX ³ shunt release 110V-130V AC | 3600 | 1 |
| 421016 | DPX ³ shunt release 220V-277V AC | 3600 | 1 |
| 421017 | DPX ³ shunt release 380V-415V AC | 3600 | 1 |
| 421018 | DPX ³ UNDER VOLT.REL-12VAC/DC | 4510 | 1 |

■ Price available on request.

* MRP - Maximum Retail Price Inclusive of all taxes including GST.

Bold Cat.Nos are products normally available with Legrand (India) Stockists. Cat.Nos that are not bold - delivery within 4 - 8 weeks from the date of order. Bold packing quantity is our mandatory packing. Orders to be placed by Legrand (India) Stockist in multiples of the same.

DPX³ MCCB

DPX³ 250 HP MCCB with New Electronics S10 Protection Unit

| Cat.Nos | Description | MRP* ₹ / Unit | Pack |
|--|--|---------------------|------|
| Accessories of DPX³ 250 HP | | | |
| 421019 | DPX ³ UNDER VOLT.REL-24VAC/DC | 4510 | 1 |
| 421020 | DPX ³ UNDER VOLT.REL-48VAC/DC | 4510 | 1 |
| 421021 | DPX ³ UNDER VOLT.REL-110VAC/DC | 4460 | 1 |
| 421022 | DPX ³ Undervoltage release 200V- 240VAC | 4460 | 1 |
| 421023 | DPX ³ UNDER VOLT.REL-277AVC/DC | 4460 | 1 |
| 421024 | DPX ³ Undervoltage release 380V- 415V AC | 4460 | 1 |
| 421025 | DPX ³ UND.VOL.REL-440-480VAC/DC | 4460 | 1 |
| 026190 | Time-lag modules - 3 Module | ■ | 1 |
| 026191 | Time-lag modules-3 Module | ■ | 1 |
| 421049 | Padlocking for locking in "Open" position for DPX ³ 125/250HP | 28420 | 1 |
| 423814 | DPX ³ 250HP RH DIRECT STD | 1810 | 1 |
| 423815 | DPX ³ 250HP RH DIRECT EMERG | 1970 | 1 |
| 423816 | DPX ³ 250HP RH VARI DEPTH STD | 2980 | 1 |
| 423817 | DPX ³ 250HP RH VARI DEPTH EMERG | 3230 | 1 |
| 423806 | AUXILIARY CNT BLOCK 1N/C+1 N/O | 2010 | 1 |
| 423850 | Plug-in bases for DPX ³ 250 HP - 3P | ■ | 1 |
| 423851 | Plug-in bases for DPX ³ 250 HP - 4P | ■ | 1 |
| 423852 | Plug-in Plug-in mobile part kit for DPX ³ 250 HP - 3P | ■ | 1 |
| 423853 | Plug-in Plug-in mobile part kit for DPX ³ 250 HP - 4P | ■ | 1 |
| 423863 | Locking support for plug-in version. To be equipped with universal keylocks Cat.No 4 238 80/81/82/83 | ■ | 1 |
| 423860 | Debro-lift mechanism for DPX ³ 250 HP ; Supplied with handle - 3P | ■ | 1 |
| 423861 | Debro-lift mechanism for DPX ³ 250 HP ; Supplied with handle - 4P | ■ | 1 |

■ Price available on request.

* MRP - Maximum Retail Price Inclusive of all taxes including GST.

| Cat.Nos | Description | MRP* ₹ / Unit | Pack |
|--|---|---------------------|------|
| Accessories of DPX³ 250 HP | | | |
| 423855 | Draw-out front cover masks for DPX ³ 250 HP alone | ■ | 1 |
| 423856 | Draw-out front cover masks for DPX ³ 250 HP with motor-driven handle | ■ | 1 |
| 423862 | Enable locking of DPX ³ 250 HP in draw-out position. To be equipped with universal keylocks Cat.No 4 238 80/81/82/83 | ■ | 1 |
| 423864 | Enable padlocking of DPX ³ HP in draw-out position | ■ | 1 |
| 422230 | Automatic auxiliary contact for DPX ³ HP draw-out version (up to 2 contacts by DPX ³ -HP) | ■ | 1 |
| 009819 | Signalling contact plugged-in / drawn-out | ■ | 1 |
| 421048 | Signalling Contact For DPX ³ 250 HP plug-in versions | ■ | 1 |

Bold Cat.Nos are products normally available with Legrand (India) Stockists. Cat.Nos that are not bold - delivery within 4 - 8 weeks from the date of order. Bold packing quantity is our mandatory packing. Orders to be placed by Legrand (India) Stockist in multiples of the same.

DPX³ MCCB

DPX³ MCCB with New Electronics S1 Protection Unit

DPX³ MCCB with electronic S1 (LSI) protection unit

- Configurable Protections with Enable and Disable possibility
- Range: 320A – 1600A, Ics=100%Icu, Two Optimum Frames
- Protection against Overloads:
 - Ir adjustable from OFF-0.4 to 1 x In
 - tr adjustable- 5s
- Protection against Short Circuits:
 - I_{sd} adjustable 1.5 to 10I_r
 - tsd - 100ms
- Breaking Capacity – 36kA, 50kA, 70kA & 100kA

| Category | Type | Rated Current (A) | 3P | | | 4P | | |
|----------|------|-------------------|---------|-------------|------|---------|-------------|------|
| | | | Cat.Nos | MRP*/₹/Unit | Pack | Cat.Nos | MRP*/₹/Unit | Pack |

Electronic S1 (LSI) Protection Unit

| | | | | | | | | |
|-------|-----------------------|------|--------|--------|---|--------|--------|---|
| 36 KA | DPX ³ 630 | 320 | 422499 | 57520 | 1 | 422504 | 70300 | 1 |
| | | 400 | 422500 | 57520 | 1 | 422505 | 70300 | 1 |
| | | 500 | 422501 | 64370 | 1 | 422506 | 86340 | 1 |
| | | 630 | 422502 | 65720 | 1 | 422507 | 88170 | 1 |
| | DPX ³ 1600 | 800 | 422540 | 110020 | 1 | 422546 | 131260 | 1 |
| | | 1000 | 422541 | 164380 | 1 | 422547 | 242590 | 1 |
| | | 1250 | 422542 | 198080 | 1 | 422548 | 295050 | 1 |
| | | 1600 | 422543 | 245140 | 1 | 422549 | 329270 | 1 |
| 50 KA | DPX ³ 630 | 320 | 422509 | 65310 | 1 | 422514 | 83310 | 1 |
| | | 400 | 422510 | 65310 | 1 | 422515 | 83310 | 1 |
| | | 500 | 422511 | 76320 | 1 | 422516 | 95410 | 1 |
| | | 630 | 422512 | 76320 | 1 | 422517 | 95410 | 1 |
| | DPX ³ 1600 | 800 | 422552 | 126500 | 1 | 422558 | 155370 | 1 |
| | | 1000 | 422553 | 175950 | 1 | 422559 | 245210 | 1 |
| | | 1250 | 422554 | 213510 | 1 | 422560 | 311220 | 1 |
| | | 1600 | 422555 | 299020 | 1 | 422561 | 352010 | 1 |

■ Price available on request.

* MRP - Maximum Retail Price Inclusive of all taxes including GST.

Bold Cat.Nos are products normally available with Legrand (India) Stockists. Cat.Nos that are not bold - delivery within 4 - 8 weeks from the date of order. Bold packing quantity is our mandatory packing. Orders to be placed by Legrand (India) Stockist in multiples of the same.

DPX³ MCCB

DPX³ MCCB with New Electronics S1 Protection Unit

| Category | Type | Rated Current (A) | 3P | | | 4P | | |
|---|-----------------------|-------------------|---------|-------------|------|---------|-------------|------|
| | | | Cat.Nos | MRP*/₹/Unit | Pack | Cat.Nos | MRP*/₹/Unit | Pack |
| Electronic S1 (LSI) Protection Unit with Electronic Earth Leakage Module - Fixed version | | | | | | | | |
| 70 KA | DPX ³ 630 | 320 | 422519 | 82810 | 1 | 422524 | 106900 | 1 |
| | | 400 | 422520 | 82810 | 1 | 422525 | 106900 | 1 |
| | | 500 | 422521 | 89510 | 1 | 422526 | 120180 | 1 |
| | | 630 | 422522 | 89510 | 1 | 422527 | 120180 | 1 |
| | DPX ³ 1600 | 800 | 422564 | 165030 | 1 | 422570 | 208860 | 1 |
| | | 1000 | 422565 | 231270 | 1 | 422571 | 330060 | 1 |
| | | 1250 | 422566 | 276950 | 1 | 422572 | 385070 | 1 |
| | | 1600 | 422567 | 372320 | 1 | 422573 | 458410 | 1 |
| 100 KA | DPX ³ 630 | 320 | 422529 | ■ | 1 | 422534 | ■ | 1 |
| | | 400 | 422530 | ■ | 1 | 422535 | ■ | 1 |
| | | 500 | 422531 | ■ | 1 | 422536 | ■ | 1 |
| | | 630 | 422532 | ■ | 1 | 422537 | ■ | 1 |
| | DPX ³ 1600 | 800 | 422576 | ■ | 1 | 422582 | ■ | 1 |
| | | 1000 | 422577 | ■ | 1 | 422583 | ■ | 1 |
| | | 1250 | 422578 | ■ | 1 | 422584 | ■ | 1 |

■ Price available on request.

* MRP - Maximum Retail Price Inclusive of all taxes including GST.

Bold Cat.Nos are products normally available with Legrand (India) Stockists. Cat.Nos that are not bold - delivery within 4 - 8 weeks from the date of order. Bold packing quantity is our mandatory packing. Orders to be placed by Legrand (India) Stockist in multiples of the same.

DPX³ MCCB

DPX³ MCCB with New Electronics S10 Protection Unit

- DPX³ MCCB with electronic S10 (LSIg) & energy metering protection unit
- Configurable Protections with Enable and Disable possibility
 - Range: 250A – 1600A, Ics=100%Icu, Two Optimum Frames
 - Protection against Overloads:
 - Ir adjustable from OFF-0.2 to 1 x In
 - tr adjustable from 3 to 30s
 - Protection against Short Circuits:
 - Isd adjustable from OFF-1.5 to 10 x Ir
 - tsd adjustable from 0 to 0.5s
 - Inbuilt Instantaneous Protection:
 - li – Fixed and 2 to 15x In through PCS
 - Protection against Ground Fault:
 - Ig adjustable from 0.2 to 1 In & OFF
 - tg adjustable from 0.80ms to 1s
 - Protection against Neutral Fault:
 - OFF-50% -100% -150% -200%
 - Breaking Capacity – 36kA, 50kA, 70kA & 100kA
 - Integrated energy metering with accuracy class 1
 - Measure for currents, voltage, frequency, power, energy, THD and Individual harmonics
 - Internal Battery with battery measure function
 - Communication ready
 - Logical Selectivity Ready (Zone Selective Interlocking)
 - In Built USB Port for Software Diagnosis
 - Switchable Thermal Memory
 - Suitable for Isolation

| Category | Type | Rated Current (A) | 3P | | | 4P | | |
|----------|------|-------------------|---------|-------------|------|---------|-------------|------|
| | | | Cat.Nos | MRP*/₹/Unit | Pack | Cat.Nos | MRP*/₹/Unit | Pack |

Electronic S10 (LSIg) Protection Unit

| | | | | | | | | |
|-------|-----------------------|------|--------|--------|---|--------|--------|---|
| 36 KA | DPX ³ 630 | 320 | 422821 | 76110 | 1 | 422826 | 82520 | 1 |
| | | 400 | 422822 | 76110 | 1 | 422827 | 82520 | 1 |
| | | 500 | 422823 | 79020 | 1 | 422828 | 95080 | 1 |
| | | 630 | 422824 | 79020 | 1 | 422829 | 95080 | 1 |
| | DPX ³ 1600 | 800 | 422921 | 160140 | 1 | 422926 | 193040 | 1 |
| | | 1000 | 422922 | 212790 | 1 | 422927 | 280000 | 1 |
| | | 1250 | 422923 | 239110 | 1 | 422928 | 320250 | 1 |
| | | 1600 | 422924 | 248620 | 1 | 422929 | 376070 | 1 |
| 50 KA | DPX ³ 630 | 320 | 422831 | 77040 | 1 | 422836 | 89620 | 1 |
| | | 400 | 422832 | 77040 | 1 | 422837 | 89620 | 1 |
| | | 500 | 422833 | 84560 | 1 | 422838 | 106640 | 1 |
| | | 630 | 422834 | 84560 | 1 | 422839 | 106640 | 1 |
| | DPX ³ 1600 | 800 | 422931 | 185370 | 1 | 422936 | 210990 | 1 |
| | | 1000 | 422932 | 230260 | 1 | 422937 | 291870 | 1 |
| | | 1250 | 422933 | 254420 | 1 | 422938 | 325590 | 1 |
| | | 1600 | 422934 | 271440 | 1 | 422939 | 386410 | 1 |
| 70 KA | DPX ³ 630 | 320 | 422841 | 90350 | 1 | 422846 | 111480 | 1 |
| | | 400 | 422842 | 90350 | 1 | 422847 | 111480 | 1 |
| | | 500 | 422843 | 104040 | 1 | 422848 | 141570 | 1 |
| | | 630 | 422844 | 104040 | 1 | 422849 | 141570 | 1 |
| | DPX ³ 1600 | 800 | 422941 | 174500 | 1 | 422946 | 210450 | 1 |
| | | 1000 | 422942 | 243910 | 1 | 422947 | 377350 | 1 |
| | | 1250 | 422943 | 339800 | 1 | 422948 | 436840 | 1 |
| | | 1600 | 422944 | 458830 | 1 | 422949 | 514960 | 1 |

■ Price available on request.

* MRP - Maximum Retail Price Inclusive of all taxes including GST.

Bold Cat.Nos are products normally available with Legrand (India) Stockists. Cat.Nos that are not bold - delivery within 4 - 8 weeks from the date of order. Bold packing quantity is our mandatory packing. Orders to be placed by Legrand (India) Stockist in multiples of the same.

DPX³ MCCB

DPX³ MCCB with New Electronics S10 Protection Unit

| Category | Type | Rated Current (A) | 3P | | | 4P | | |
|----------|------|-------------------|---------|-------------|------|---------|-------------|------|
| | | | Cat.Nos | MRP*/₹/Unit | Pack | Cat.Nos | MRP*/₹/Unit | Pack |

Electronic S10 (LSIg) Protection Unit

| | | | | | | | | |
|--------|-----------------------|------|--------|---|---|--------|---|---|
| 100 KA | DPX ³ 630 | 320 | 422851 | ■ | 1 | 422856 | ■ | 1 |
| | | 400 | 422852 | ■ | 1 | 422857 | ■ | 1 |
| | | 500 | 422853 | ■ | 1 | 422858 | ■ | 1 |
| | | 630 | 422854 | ■ | 1 | 422859 | ■ | 1 |
| | DPX ³ 1600 | 800 | 422951 | ■ | 1 | 422956 | ■ | 1 |
| | | 1000 | 422952 | ■ | 1 | 422957 | ■ | 1 |
| | | 1250 | 422953 | ■ | 1 | 422958 | ■ | 1 |
| | | | | | | | | |

Electronic S10 (LSIg) Protection Unit with Measure

| | | | | | | | | |
|--------|-----------------------|------|--------|--------|---|--------|--------|---|
| 36 KA | DPX ³ 630 | 320 | 422861 | 95430 | 1 | 422866 | 108530 | 1 |
| | | 400 | 422862 | 95430 | 1 | 422867 | 108530 | 1 |
| | | 500 | 422863 | 101280 | 1 | 422868 | 122920 | 1 |
| | | 630 | 422864 | 101280 | 1 | 422869 | 122920 | 1 |
| | DPX ³ 1600 | 800 | 422961 | 184500 | 1 | 422966 | 214950 | 1 |
| | | 1000 | 422962 | 235660 | 1 | 422967 | 309620 | 1 |
| | | 1250 | 422963 | 255580 | 1 | 422968 | 345110 | 1 |
| | | 1600 | 422964 | 270760 | 1 | 422969 | 400330 | 1 |
| 50 KA | DPX ³ 630 | 320 | 422871 | 100240 | 1 | 422876 | 115720 | 1 |
| | | 400 | 422872 | 100240 | 1 | 422877 | 115720 | 1 |
| | | 500 | 422873 | 110320 | 1 | 422878 | 134660 | 1 |
| | | 630 | 422874 | 110320 | 1 | 422879 | 134660 | 1 |
| | DPX ³ 1600 | 800 | 422971 | 166710 | 1 | 422976 | 201150 | 1 |
| | | 1000 | 422972 | 199110 | 1 | 422977 | 299760 | 1 |
| | | 1250 | 422973 | 283980 | 1 | 422978 | 366810 | 1 |
| | | 1600 | 422974 | 335260 | 1 | 422979 | 426950 | 1 |
| 70 KA | DPX ³ 630 | 320 | 422881 | 113550 | 1 | 422886 | 133940 | 1 |
| | | 400 | 422882 | 113550 | 1 | 422887 | 133940 | 1 |
| | | 500 | 422883 | 126830 | 1 | 422888 | 163140 | 1 |
| | | 630 | 422884 | 126830 | 1 | 422889 | 163140 | 1 |
| | DPX ³ 1600 | 800 | 422981 | 177080 | 1 | 422986 | 229750 | 1 |
| | | 1000 | 422982 | 280030 | 1 | 422987 | 371580 | 1 |
| | | 1250 | 422983 | 322040 | 1 | 422988 | 426420 | 1 |
| | | 1600 | 422984 | 426560 | 1 | 422989 | 498450 | 1 |
| 100 KA | DPX ³ 630 | 320 | 422891 | ■ | 1 | 422896 | ■ | 1 |
| | | 400 | 422892 | ■ | 1 | 422897 | ■ | 1 |
| | | 500 | 422893 | ■ | 1 | 422898 | ■ | 1 |
| | | 630 | 422894 | ■ | 1 | 422899 | ■ | 1 |
| | DPX ³ 1600 | 800 | 422991 | ■ | 1 | 422996 | ■ | 1 |
| | | 1000 | 422992 | ■ | 1 | 422997 | ■ | 1 |
| | | 1250 | 422993 | ■ | 1 | 422998 | ■ | 1 |
| | | | | | | | | |

■ Price available on request.

* MRP - Maximum Retail Price Inclusive of all taxes including GST.

Bold Cat.Nos are products normally available with Legrand (India) Stockists. Cat.Nos that are not bold - delivery within 4 - 8 weeks from the date of order. Bold packing quantity is our mandatory packing. Orders to be placed by Legrand (India) Stockist in multiples of the same.

DPX³ MCCB

DPX³ MCCB with Thermal Magnetic Protection Unit

- Range: 16A – 1250A, Ics=100%Icu, Four Optimum Frames
 - Thermal Adjustable – 0.8 to 1In, Magnetic Adjustable** – 5 to 10In
 - Breaking Capacity# – 16kA, 25kA, 36kA, 50kA, 70kA & 100kA
 - Option for In built or add on module for Earth Leakage Protection##
 - Adjustable sensitivity: 0.03 - 0.3 - 1 - 3 A
 - Adjustable tripping: 0 - 0.3 - 1 - 3s
 - Suitable for Isolation
- ** Fixed at 10In for DPX³ 160
 # Refer Catalogue for frame wise data
 ## For DPX³ 160, DPX³ 250 and DPX³ 630 Only

| Category | Type | Rated Current (A) | 3P | | | 4P | | |
|----------|------|-------------------|---------|-------------|------|---------|-------------|------|
| | | | Cat.Nos | MRP*/₹/Unit | Pack | Cat.Nos | MRP*/₹/Unit | Pack |

Thermal Magnetic : O/L & S/C Protection

| | | | | | | | | |
|-------|----------------------|-----|---------|-------|---|---------|-------|---|
| 16 KA | DPX ³ 160 | 16 | 4200 00 | 9700 | 1 | 4200 10 | 12920 | 1 |
| | | 25 | 4200 01 | 9700 | 1 | 4200 11 | 12920 | 1 |
| | | 40 | 4200 02 | 9700 | 1 | 4200 12 | 12920 | 1 |
| | | 63 | 4200 03 | 9700 | 1 | 4200 13 | 12920 | 1 |
| | | 80 | 4200 04 | 9700 | 1 | 4200 14 | 12920 | 1 |
| | | 100 | 4200 05 | 9700 | 1 | 4200 15 | 12920 | 1 |
| | | 125 | 4200 06 | 10490 | 1 | 4200 16 | 13010 | 1 |
| | | 160 | 4200 07 | 13540 | 1 | 4200 17 | 17040 | 1 |
| 25 KA | DPX ³ 160 | 16 | 4200 40 | 11340 | 1 | 4200 50 | 15760 | 1 |
| | | 25 | 4200 41 | 11340 | 1 | 4200 51 | 15760 | 1 |
| | | 40 | 4200 42 | 11340 | 1 | 4200 52 | 15760 | 1 |
| | | 63 | 4200 43 | 11340 | 1 | 4200 53 | 15760 | 1 |
| | | 80 | 4200 44 | 11340 | 1 | 4200 54 | 15760 | 1 |
| | | 100 | 4200 45 | 11340 | 1 | 4200 55 | 15760 | 1 |
| | | 125 | 4200 46 | 16390 | 1 | 4200 56 | 19900 | 1 |
| | | 160 | 4200 47 | 21310 | 1 | 4200 57 | 25340 | 1 |
| | DPX ³ 250 | 200 | 4202 08 | 29450 | 1 | 4202 18 | 35580 | 1 |
| | | 250 | 4202 09 | 34140 | 1 | 4202 19 | 46010 | 1 |

■ Price available on request.

* MRP - Maximum Retail Price Inclusive of all taxes including GST.

Bold Cat.Nos are products normally available with Legrand (India) Stockists. Cat.Nos that are not bold - delivery within 4 - 8 weeks from the date of order. Bold packing quantity is our mandatory packing. Orders to be placed by Legrand (India) Stockist in multiples of the same.

DPX³ MCCB

DPX³ MCCB with Thermal Magnetic Protection Unit

| Category | Type | Rated Current (A) | 3P | | | 4P | | |
|----------|------|-------------------|---------|-------------|------|---------|-------------|------|
| | | | Cat.Nos | MRP*/₹/Unit | Pack | Cat.Nos | MRP*/₹/Unit | Pack |

Thermal Magnetic : O/L & S/C Protection

| | | | | | | | | |
|-----------------------|----------------------|---------|---------|-------|---------|---------|-------|---|
| 36 KA | DPX ³ 160 | 16 | 4200 80 | 14360 | 1 | 4200 90 | 17930 | 1 |
| | | 25 | 4200 81 | 14360 | 1 | 4200 91 | 17930 | 1 |
| | | 40 | 4200 82 | 14360 | 1 | 4200 92 | 17930 | 1 |
| | | 63 | 4200 83 | 14360 | 1 | 4200 93 | 17930 | 1 |
| | | 80 | 4200 84 | 14360 | 1 | 4200 94 | 17930 | 1 |
| | | 100 | 4200 85 | 14360 | 1 | 4200 95 | 17930 | 1 |
| | | 125 | 4200 86 | 16850 | 1 | 4200 96 | 21980 | 1 |
| | | 160 | 4200 87 | 21700 | 1 | 4200 97 | 25550 | 1 |
| | DPX ³ 250 | 200 | 4202 38 | 37120 | 1 | 4202 48 | 46930 | 1 |
| | | 250 | 4202 39 | 41180 | 1 | 4202 49 | 50260 | 1 |
| | DPX ³ 630 | 320 | 4220 01 | 49730 | 1 | 4220 06 | 56480 | 1 |
| | | 400 | 4220 02 | 49730 | 1 | 4220 07 | 57720 | 1 |
| | | 500 | 4220 03 | 59830 | 1 | 4220 08 | 71170 | 1 |
| | | 630 | 4220 04 | 59830 | 1 | 4220 09 | 73000 | 1 |
| DPX ³ 1600 | 800 | 4222 52 | 91310 | 1 | 4222 57 | 106190 | 1 | |
| | 1000 | 4222 53 | 107570 | 1 | 4222 58 | 150650 | 1 | |
| | 1250 | 4222 54 | 166160 | 1 | 4222 59 | 181240 | 1 | |

■ Price available on request.

* MRP - Maximum Retail Price inclusive of all taxes including GST.

Bold Cat.Nos are products normally available with Legrand (India) Stockists. Cat.Nos that are not bold - delivery within 4 - 8 weeks from the date of order. Bold packing quantity is our mandatory packing. Orders to be placed by Legrand (India) Stockist in multiples of the same.

DPX³ MCCB

DPX³ MCCB with Thermal Magnetic Protection Unit

| Category | Type | Rated Current (A) | 3P | | | 4P | | | |
|--|-----------------------|----------------------|---------|-------------|-------|---------|-------------|-------|---|
| | | | Cat.Nos | MRP*/₹/Unit | Pack | Cat.Nos | MRP*/₹/Unit | Pack | |
| Thermal Magnetic : O/L & S/C Protection | | | | | | | | | |
| 50 KA | DPX ³ 160 | 16 | 4201 20 | 19130 | 1 | 4201 30 | 24110 | 1 | |
| | | 25 | 4201 21 | 19130 | 1 | 4201 31 | 24110 | 1 | |
| | | 40 | 4201 22 | 19130 | 1 | 4201 32 | 24110 | 1 | |
| | | 63 | 4201 23 | 19130 | 1 | 4201 33 | 24110 | 1 | |
| | | 80 | 4201 24 | 19130 | 1 | 4201 34 | 24110 | 1 | |
| | | 100 | 4201 25 | 19130 | 1 | 4201 35 | 24110 | 1 | |
| | | 125 | 4201 26 | 25080 | 1 | 4201 36 | 28900 | 1 | |
| | | 160 | 4201 27 | 28220 | 1 | 4201 37 | 32830 | 1 | |
| | DPX ³ 250 | 200 | 4202 68 | 44980 | 1 | 4202 78 | 56820 | 1 | |
| | | 250 | 4202 69 | 47470 | 1 | 4202 79 | 59100 | 1 | |
| | DPX ³ 630 | 320 | 4220 15 | 49940 | 1 | 4220 20 | 65810 | 1 | |
| | | 400 | 4220 16 | 55150 | 1 | 4220 21 | 65810 | 1 | |
| | | 500 | 4220 17 | 63150 | 1 | 4220 22 | 86220 | 1 | |
| | | 630 | 4220 18 | 68270 | 1 | 4220 23 | 88400 | 1 | |
| | DPX ³ 1600 | 800 | 4222 64 | 100520 | 1 | 4222 69 | 125410 | 1 | |
| | | 1000 | 4222 65 | 153010 | 1 | 4222 70 | 177010 | 1 | |
| | | 1250 | 4222 66 | 224780 | 1 | 4222 71 | 236020 | 1 | |
| | 70 KA | DPX ³ 250 | 100 | 4206 05 | 39400 | 1 | 4206 15 | 43490 | 1 |
| | | | 160 | 4206 07 | 49220 | 1 | 4206 17 | 61200 | 1 |
| | | | 200 | 4206 08 | 60610 | 1 | 4206 18 | 74580 | 1 |
| | | | 250 | 4206 09 | 64420 | 1 | 4206 19 | 77640 | 1 |
| DPX ³ 630 | | 320 | 4220 29 | 65260 | 1 | 4220 34 | 80820 | 1 | |
| | | 400 | 4220 30 | 65270 | 1 | 4220 35 | 80820 | 1 | |
| | | 500 | 4220 31 | 76200 | 1 | 4220 36 | 98180 | 1 | |
| | | 630 | 4220 32 | 80090 | 1 | 4220 37 | 106140 | 1 | |
| DPX ³ 1600 | | 800 | 4222 76 | 148620 | 1 | 4222 81 | 186260 | 1 | |
| | | 1000 | 4222 77 | 222840 | 1 | 4222 82 | 315530 | 1 | |
| | | 1250 | 4222 78 | 228300 | 1 | 4222 83 | 393340 | 1 | |

* MRP - Maximum Retail Price Inclusive of all taxes including GST.
 ■ Price available on request.

Bold Cat.Nos are products normally available with Legrand (India) Stockists. Cat.Nos that are not bold - delivery within 4 - 8 weeks from the date of order. Bold packing quantity is our mandatory packing. Orders to be placed by Legrand (India) Stockist in multiples of the same.

DPX³ MCCB

DPX³ MCCB with Thermal Magnetic Protection Unit

| Category | Type | Rated Current (A) | 3P | | | 4P | | | | |
|---|----------------------|-------------------|----------------------|-------------|---------|---------|-------------|---------|-------|---|
| | | | Cat.Nos | MRP*/₹/Unit | Pack | Cat.Nos | MRP*/₹/Unit | Pack | | |
| Thermal Magnetic + Electronic Earth Leakage Module | | | | | | | | | | |
| 16 KA | DPX ³ 160 | 16 | - | - | - | 4200 30 | 41830 | 1 | | |
| | | 25 | - | - | - | 4200 31 | 41830 | 1 | | |
| | | 40 | - | - | - | 4200 32 | 41830 | 1 | | |
| | | 63 | - | - | - | 4200 33 | 41830 | 1 | | |
| | | 80 | - | - | - | 4200 34 | 41830 | 1 | | |
| | | 100 | - | - | - | 4200 35 | 41830 | 1 | | |
| | | 125 | - | - | - | 4200 36 | 44110 | 1 | | |
| | | 160 | - | - | - | 4200 37 | 55970 | 1 | | |
| 25 KA | DPX ³ 160 | 16 | - | - | - | 4200 70 | 52950 | 1 | | |
| | | 25 | - | - | - | 4200 71 | 52950 | 1 | | |
| | | 40 | - | - | - | 4200 72 | 52950 | 1 | | |
| | | 63 | - | - | - | 4200 73 | 52950 | 1 | | |
| | | 80 | - | - | - | 4200 74 | 52950 | 1 | | |
| | | 100 | - | - | - | 4200 75 | 52950 | 1 | | |
| | | 125 | - | - | - | 4200 76 | 52970 | 1 | | |
| | | 160 | - | - | - | 4200 77 | 62540 | 1 | | |
| | DPX ³ 250 | 100 | - | - | - | 4202 25 | 63840 | 1 | | |
| | | 160 | - | - | - | 4202 27 | 67100 | 1 | | |
| | | 200 | - | - | - | 4202 28 | 69700 | 1 | | |
| | | 250 | - | - | - | 4202 29 | 74540 | 1 | | |
| | | 36 KA | DPX ³ 160 | 16 | - | - | - | 4201 10 | 64410 | 1 |
| | | | | 25 | - | - | - | 4201 11 | 64410 | 1 |
| 40 | - | | | - | - | 4201 12 | 64410 | 1 | | |
| 63 | - | | | - | - | 4201 13 | 64410 | 1 | | |
| 80 | - | | | - | - | 4201 14 | 64410 | 1 | | |
| 100 | - | | | - | - | 4201 15 | 64410 | 1 | | |
| 125 | - | | | - | - | 4201 16 | 64760 | 1 | | |
| 160 | - | | | - | - | 4201 17 | 77030 | 1 | | |
| DPX ³ 250 | 100 | - | - | - | 4202 55 | 66640 | 1 | | | |
| | 160 | - | - | - | 4202 57 | 77630 | 1 | | | |
| | 200 | - | - | - | 4202 58 | 81410 | 1 | | | |
| | 250 | - | - | - | 4202 59 | 87060 | 1 | | | |
| 50 KA | DPX ³ 160 | 16 | - | - | - | 4201 50 | 74590 | 1 | | |
| | | 25 | - | - | - | 4201 51 | 74590 | 1 | | |
| | | 40 | - | - | - | 4201 52 | 74590 | 1 | | |
| | | 63 | - | - | - | 4201 53 | 74590 | 1 | | |
| | | 80 | - | - | - | 4201 54 | 74590 | 1 | | |
| | | 100 | - | - | - | 4201 55 | 74590 | 1 | | |
| | | 125 | - | - | - | 4201 56 | 79470 | 1 | | |
| | | 160 | - | - | - | 4201 57 | 85040 | 1 | | |
| | DPX ³ 250 | 100 | - | - | - | 4202 85 | 79960 | 1 | | |
| | | 160 | - | - | - | 4202 87 | 92560 | 1 | | |
| | | 200 | - | - | - | 4202 88 | 97530 | 1 | | |
| | | 250 | - | - | - | 4202 89 | 103630 | 1 | | |

■ Price available on request.

* MRP - Maximum Retail Price Inclusive of all taxes including GST.

Bold Cat.Nos are products normally available with Legrand (India) Stockists. Cat.Nos that are not bold - delivery within 4 - 8 weeks from the date of order. Bold packing quantity is our mandatory packing. Orders to be placed by Legrand (India) Stockist in multiples of the same.

DPX³ MCCB

DPX³ MCCB with Electronic S2* (LSI)* Protection Pnit

- Range: 40A – 1600A, Ics=100%Icu, Three Optimum Frames
- Protection against overloads:
 - Ir adjustable from 0.4 to 1 x In
 - tr adjustable from 3 to 30s#
- Protection against short circuits:
 - Isd adjustable from 1.5 to 10 x Ir
 - tsd adjustable from 0 to 0.5s
- Inbuilt Instantaneous Protection:
 - li# – Fixed
- Option for In built or add on module for Earth Leakage Protection##
 - Adjustable sensitivity: 0.03 - 0.3 - 1 - 3 A
 - Adjustable tripping: 0 - 0.3 - 1 - 3s
- Breaking Capacity# – 25kA, 36kA, 50kA, 70kA & 100kA
- In built Display for Current Metering with accuracy of class 1
- Internal Battery with battery measure function
- Communication Ready via COMM Port
- Logical Selectivity Ready (Zone Selective Interlocking)
- Dynamic Selectivity as per Selectivity Charts
- In Built USB Port for Software Diagnosis
- Suitable for Isolation

| Category | Type | Rated Current (A) | 3P | | | 4P | | |
|----------|------|-------------------|---------|-------------|------|---------|-------------|------|
| | | | Cat.Nos | MRP*/₹/Unit | Pack | Cat.Nos | MRP*/₹/Unit | Pack |

Electronic S2

| | | | | | | | | |
|-----------------------|-----------------------|---------|---------|-------|---------|---------|-------|---|
| 25 KA | DPX ³ 250 | 40 | 4203 02 | 31420 | 1 | 4203 12 | 41260 | 1 |
| | | 100 | 4203 05 | 31420 | 1 | 4203 15 | 41260 | 1 |
| | | 160 | 4203 07 | 40700 | 1 | 4203 17 | 48680 | 1 |
| | | 250 | 4203 09 | 53080 | 1 | 4203 19 | 65810 | 1 |
| 36 KA | DPX ³ 250 | 40 | 4203 32 | 35290 | 1 | 4203 42 | 43500 | 1 |
| | | 100 | 4203 35 | 35290 | 1 | 4203 45 | 43500 | 1 |
| | | 160 | 4203 37 | 44230 | 1 | 4203 47 | 59010 | 1 |
| | | 250 | 4203 39 | 59260 | 1 | 4203 49 | 68190 | 1 |
| | DPX ³ 630 | 320 | 4220 57 | ■ | 1 | 4220 62 | ■ | 1 |
| | | 400 | 4220 58 | ■ | 1 | 4220 63 | ■ | 1 |
| | | 500 | 4220 59 | ■ | 1 | 4220 64 | ■ | 1 |
| | | 630 | 4220 60 | ■ | 1 | 4220 65 | ■ | 1 |
| DPX ³ 1600 | 800 | 4223 00 | ■ | 1 | 4223 06 | ■ | 1 | |
| | 1000 | 4223 01 | ■ | 1 | 4223 07 | ■ | 1 | |
| | 1250 | 4223 02 | ■ | 1 | 4223 08 | ■ | 1 | |
| | 1600 | 4223 03 | ■ | 1 | 4223 09 | ■ | 1 | |
| 50 KA | DPX ³ 250 | 40 | 4203 62 | 41960 | 1 | 4203 72 | 55910 | 1 |
| | | 100 | 4203 65 | 41960 | 1 | 4203 75 | 55910 | 1 |
| | | 160 | 4203 67 | 50650 | 1 | 4203 77 | 60490 | 1 |
| | | 250 | 4203 69 | 67590 | 1 | 4203 79 | 81820 | 1 |
| | DPX ³ 630 | 320 | 4220 67 | ■ | 1 | 4220 72 | ■ | 1 |
| | | 400 | 4220 68 | ■ | 1 | 4220 73 | ■ | 1 |
| | | 500 | 4220 69 | ■ | 1 | 4220 74 | ■ | 1 |
| | | 630 | 4220 70 | ■ | 1 | 4220 75 | ■ | 1 |
| | DPX ³ 1600 | 800 | 4223 12 | ■ | 1 | 4223 18 | ■ | 1 |
| | | 1000 | 4223 13 | ■ | 1 | 4223 19 | ■ | 1 |
| | | 1250 | 4223 14 | ■ | 1 | 4223 20 | ■ | 1 |
| | | 1600 | 4223 15 | ■ | 1 | 4223 21 | ■ | 1 |

* MRP - Maximum Retail Price Inclusive of all taxes including GST.
 ■ Price available on request.

Bold Cat.Nos are products normally available with Legrand (India) Stockists. Cat.Nos that are not bold - delivery within 4 - 8 weeks from the date of order. Bold packing quantity is our mandatory packing. Orders to be placed by Legrand (India) Stockist in multiples of the same.

DPX³ MCCB

DPX³ MCCB with Electronic S2[#] (LSI)[#] Protection Unit

| Category | Type | Rated Current (A) | 3P | | | 4P | | |
|----------|------|-------------------|---------|-------------|------|---------|-------------|------|
| | | | Cat.Nos | MRP*/₹/Unit | Pack | Cat.Nos | MRP*/₹/Unit | Pack |

Electronic S2

| | | | | | | | | |
|-------|-----------------------|------|---------|-------|---|---------|--------|---|
| 70 KA | DPX ³ 250 | 40 | 4206 35 | 51350 | 1 | 4206 45 | 67920 | 1 |
| | | 100 | 4206 37 | 51860 | 1 | 4206 47 | 67920 | 1 |
| | | 160 | 4206 38 | 67920 | 1 | 4206 48 | 78020 | 1 |
| | | 250 | 4206 39 | 77540 | 1 | 4206 49 | 100080 | 1 |
| | DPX ³ 630 | 320 | 4220 77 | ■ | 1 | 4220 82 | ■ | 1 |
| | | 400 | 4220 78 | ■ | 1 | 4220 83 | ■ | 1 |
| | | 500 | 4220 79 | ■ | 1 | 4220 84 | ■ | 1 |
| | | 630 | 4220 80 | ■ | 1 | 4220 85 | ■ | 1 |
| | DPX ³ 1600 | 800 | 4223 24 | ■ | 1 | 4223 30 | ■ | 1 |
| | | 1000 | 4223 25 | ■ | 1 | 4223 31 | ■ | 1 |
| | | 1250 | 4223 26 | ■ | 1 | 4223 32 | ■ | 1 |
| | | 1600 | 4223 27 | ■ | 1 | 4223 33 | ■ | 1 |

Electronic S2 + Electronic Earth Leakage Module

| | | | | | | | | |
|-------|----------------------|-----|---|---|---|---------|---|---|
| 25 kA | DPX ³ 250 | 40 | - | - | ■ | 4203 22 | ■ | 1 |
| | | 100 | - | - | ■ | 4203 25 | ■ | 1 |
| | | 160 | - | - | ■ | 4203 27 | ■ | 1 |
| | | 250 | - | - | ■ | 4203 29 | ■ | 1 |
| 36 kA | DPX ³ 250 | 40 | - | - | ■ | 4203 52 | ■ | 1 |
| | | 100 | - | - | ■ | 4203 55 | ■ | 1 |
| | | 160 | - | - | ■ | 4203 57 | ■ | 1 |
| | | 250 | - | - | ■ | 4203 59 | ■ | 1 |
| 50 kA | DPX ³ 250 | 40 | - | - | ■ | 4203 82 | ■ | 1 |
| | | 100 | - | - | ■ | 4203 85 | ■ | 1 |
| | | 160 | - | - | ■ | 4203 87 | ■ | 1 |
| | | 250 | - | - | ■ | 4203 89 | ■ | 1 |
| 70 kA | DPX ³ 250 | 40 | - | - | ■ | 4206 55 | ■ | 1 |
| | | 100 | - | - | ■ | 4206 57 | ■ | 1 |
| | | 160 | - | - | ■ | 4206 58 | ■ | 1 |
| | | 250 | - | - | ■ | 4206 59 | ■ | 1 |

■ Price available on request.

* MRP - Maximum Retail Price Inclusive of all taxes including GST.

Bold Cat.Nos are products normally available with Legrand (India) Stockists. Cat.Nos that are not bold - delivery within 4 - 8 weeks from the date of order. Bold packing quantity is our mandatory packing. Orders to be placed by Legrand (India) Stockist in multiples of the same.

DPX³ MCCB

DPX³ MCCB with Electronic Sg (LSIg) Protection Unit

- Range: 40A – 1600A, Ics=100%Icu, Three Optimum Frames
- Protection against Overloads:
 - Ir adjustable from 0.4 to 1 x In
 - tr adjustable from 3 to 30s#
- Protection against Short Circuits:
 - Isd adjustable from 1.5 to 10 x Ir
 - tsd adjustable from 0 to 0.5s
- Inbuilt Instantaneous Protection:
 - li# – Fixed
- Protection against Ground Fault:
 - Ig adjustable from 0.2 to 1 In & OFF
 - tg adjustable from 0.1 to 1s
- Breaking Capacity#– 25kA, 36kA, 50kA, 70kA & 100kA
- In built Display for Current Metering with high accuracy of class 1
- Internal Battery with battery measure function
- Communication Ready via COMM Port
- Logical Selectivity Ready (Zone Selective Interlocking)
- Dynamic Selectivity as per Selectivity Charts
- In Built USB Port for Software Diagnosis
- Switchable Thermal Memory
- Suitable for Isolation

| Category | Type | Rated Current (A) | 3P | | | 4P | | |
|----------|------|-------------------|---------|-------------|------|---------|-------------|------|
| | | | Cat.Nos | MRP*/₹/Unit | Pack | Cat.Nos | MRP*/₹/Unit | Pack |

Electronic Sg

| | | | | | | | | |
|-----------------------|-----------------------|---------|---------|-------|---------|---------|-------|---|
| 25 KA | DPX ³ 250 | 40 | 4205 02 | 58370 | 1 | 4205 12 | 65350 | 1 |
| | | 100 | 4205 05 | 58370 | 1 | 4205 15 | 65350 | 1 |
| | | 160 | 4205 07 | 64950 | 1 | 4205 17 | 72010 | 1 |
| | | 250 | 4205 09 | 71800 | 1 | 4205 19 | 84020 | 1 |
| 36 KA | DPX ³ 250 | 40 | 4205 22 | 61810 | 1 | 4205 32 | 69650 | 1 |
| | | 100 | 4205 25 | 61810 | 1 | 4205 35 | 69650 | 1 |
| | | 160 | 4205 27 | 68260 | 1 | 4205 37 | 72390 | 1 |
| | | 250 | 4205 29 | 70100 | 1 | 4205 39 | 74240 | 1 |
| | DPX ³ 630 | 320 | 4221 37 | ■ | 1 | 4221 42 | ■ | 1 |
| | | 400 | 4221 38 | ■ | 1 | 4221 43 | ■ | 1 |
| | | 500 | 4221 39 | ■ | 1 | 4221 44 | ■ | 1 |
| | | 630 | 4221 40 | ■ | 1 | 4221 45 | ■ | 1 |
| DPX ³ 1600 | 800 | 4223 96 | ■ | 1 | 4224 02 | ■ | 1 | |
| | 1000 | 4223 97 | ■ | 1 | 4224 03 | ■ | 1 | |
| | 1250 | 4223 98 | ■ | 1 | 4224 04 | ■ | 1 | |
| | 1600 | 4223 99 | ■ | 1 | 4224 05 | ■ | 1 | |
| 50 KA | DPX ³ 250 | 40 | 4205 42 | 63660 | 1 | 4205 52 | 70370 | 1 |
| | | 100 | 4205 45 | 63660 | 1 | 4205 55 | 70370 | 1 |
| | | 160 | 4205 47 | 70070 | 1 | 4205 57 | 76640 | 1 |
| | | 250 | 4205 49 | 71900 | 1 | 4205 59 | 89800 | 1 |
| | DPX ³ 630 | 320 | 4221 47 | ■ | 1 | 4221 52 | ■ | 1 |
| | | 400 | 4221 48 | ■ | 1 | 4221 53 | ■ | 1 |
| | | 500 | 4221 49 | ■ | 1 | 4221 54 | ■ | 1 |
| | | 630 | 4221 50 | ■ | 1 | 4221 55 | ■ | 1 |
| | DPX ³ 1600 | 800 | 4224 08 | ■ | 1 | 4224 14 | ■ | 1 |
| | | 1000 | 4224 09 | ■ | 1 | 4224 15 | ■ | 1 |
| | | 1250 | 4224 10 | ■ | 1 | 4224 16 | ■ | 1 |
| | | 1600 | 4224 11 | ■ | 1 | 4224 17 | ■ | 1 |

* MRP - Maximum Retail Price Inclusive of all taxes including GST.
 ■ Price available on request.

Bold Cat.Nos are products normally available with Legrand (India) Stockists. Cat.Nos that are not bold - delivery within 4 - 8 weeks from the date of order. Bold packing quantity is our mandatory packing. Orders to be placed by Legrand (India) Stockist in multiples of the same.

DPX³ MCCB

DPX³ MCCB with Electronic Sg (LSIg) Protection Unit

| Category | Type | Rated Current (A) | 3P | | | 4P | | |
|----------------------|-----------------------|-------------------|---------|-------------|------|---------|-------------|------|
| | | | Cat.Nos | MRP*/₹/Unit | Pack | Cat.Nos | MRP*/₹/Unit | Pack |
| Electronic Sg | | | | | | | | |
| 70 kA | DPX ³ 250 | 40 | 4206 92 | 66910 | 1 | 4207 02 | 75840 | 1 |
| | | 100 | 4206 95 | 66910 | 1 | 4207 05 | 75840 | 1 |
| | | 160 | 4206 97 | 78230 | 1 | 4207 07 | 87460 | 1 |
| | | 250 | 4206 99 | 80120 | 1 | 4207 09 | 92060 | 1 |
| | DPX ³ 630 | 320 | 4221 57 | ■ | 1 | 4221 62 | ■ | 1 |
| | | 400 | 4221 58 | ■ | 1 | 4221 63 | ■ | 1 |
| | | 500 | 4221 59 | ■ | 1 | 4221 64 | ■ | 1 |
| | | 630 | 4221 60 | ■ | 1 | 4221 65 | ■ | 1 |
| | DPX ³ 1600 | 800 | 4224 20 | ■ | 1 | 4224 26 | ■ | 1 |
| | | 1000 | 4224 21 | ■ | 1 | 4224 27 | ■ | 1 |
| | | 1250 | 4224 22 | ■ | 1 | 4224 28 | ■ | 1 |
| | | 1600 | 4224 23 | ■ | 1 | 4224 29 | ■ | 1 |

DPX³ MCCB

DPX³ MCCB with Electronic S2[#] (LSI)[#] & Energy Metering Protection Unit

- Range: 40A – 1600A, Ics=100%Icu, Three Optimum Frames
- Protection against overloads:
 - Ir adjustable from 0.4 to 1 x In
 - tr adjustable from 3 to 30s#
- Protection against short circuits:
 - Isd adjustable from 1.5 to 10 x Ir
 - tsd adjustable from 0 to 0.5s
- Inbuilt Instantaneous Protection:
 - li# – Fixed
- Option for In built or add on module for Earth Leakage Protection##
 - Adjustable sensitivity: 0.03 - 0.3 - 1 - 3 A
 - Adjustable tripping: 0 - 0.3 - 1 - 3s
- Breaking Capacity# – 25kA, 36kA, 50kA, 70kA & 100kA
- Integrated energy metering with accuracy class 2
- Measure for currents, voltage, frequency, power, energy and harmonics
- Internal Battery with battery measure function
- Communication Ready via COMM Port
- Logical Selectivity Ready (Zone Selective Interlocking)
- Dynamic Selectivity as per Selectivity Charts
- In Built USB Port for Software Diagnosis
- Suitable for Isolation

| Category | Type | Rated Current (A) | 3P | | | 4P | | |
|----------|------|-------------------|---------|-------------|------|---------|-------------|------|
| | | | Cat.Nos | MRP*/₹/Unit | Pack | Cat.Nos | MRP*/₹/Unit | Pack |

Electronic S2 + Energy Metering

| | | | | | | | | |
|-------|----------------------|-----|---------|-------|---|---------|-------|---|
| 25 KA | DPX ³ 250 | 40 | 4204 02 | 62990 | 1 | 4204 12 | 72110 | 1 |
| | | 100 | 4204 05 | 62990 | 1 | 4204 15 | 72130 | 1 |
| | | 160 | 4204 07 | 68300 | 1 | 4204 17 | 78180 | 1 |
| | | 250 | 4204 09 | 73950 | 1 | 4204 19 | 84320 | 1 |
| 36 kA | DPX ³ 250 | 40 | 4204 32 | 67370 | 1 | 4204 42 | 73170 | 1 |
| | | 100 | 4204 35 | 67370 | 1 | 4204 45 | 73170 | 1 |
| | | 160 | 4204 37 | 73460 | 1 | 4204 47 | 82110 | 1 |
| | | 250 | 4204 39 | 79370 | 1 | 4204 49 | 92390 | 1 |
| | DPX ³ 630 | 320 | 4220 97 | ■ | 1 | 4221 02 | ■ | 1 |
| | | 400 | 4220 98 | ■ | 1 | 4221 03 | ■ | 1 |
| | | 500 | 4220 99 | ■ | 1 | 4221 04 | ■ | 1 |
| | | 630 | 4221 00 | ■ | 1 | 4221 05 | ■ | 1 |

■ Price available on request.

* MRP - Maximum Retail Price Inclusive of all taxes including GST.

Bold Cat.Nos are products normally available with Legrand (India) Stockists. Cat.Nos that are not bold - delivery within 4 - 8 weeks from the date of order. Bold packing quantity is our mandatory packing. Orders to be placed by Legrand (India) Stockist in multiples of the same.

DPX³ MCCB
DPX³ MCCB with Electronic S2[#] (LSI)[#] & Energy Metering Protection Unit

| Category | Type | Rated Current (A) | 3P | | | 4P | | |
|----------|------|-------------------|---------|-------------|------|---------|-------------|------|
| | | | Cat.Nos | MRP*/₹/Unit | Pack | Cat.Nos | MRP*/₹/Unit | Pack |

Electronic S2 + Energy Metering

| | | | | | | | | |
|-----------------------|-----------------------|---------|---------|-------|---------|---------|--------|---|
| 36 KA | DPX ³ 1600 | 800 | 4223 48 | ■ | 1 | 4223 54 | ■ | 1 |
| | | 1000 | 4223 49 | ■ | 1 | 4223 55 | ■ | 1 |
| | | 1250 | 4223 50 | ■ | 1 | 4223 56 | ■ | 1 |
| | | 1600 | 4223 51 | ■ | 1 | 4223 57 | ■ | 1 |
| 50 KA | DPX ³ 250 | 40 | 4204 62 | 75880 | 1 | 4204 72 | 82150 | 1 |
| | | 100 | 4204 65 | 75880 | 1 | 4204 75 | 82150 | 1 |
| | | 160 | 4204 67 | 83350 | 1 | 4204 77 | 90320 | 1 |
| | | 250 | 4204 69 | 88130 | 1 | 4204 79 | 101770 | 1 |
| | DPX ³ 630 | 320 | 4221 07 | ■ | 1 | 4221 12 | ■ | 1 |
| | | 400 | 4221 08 | ■ | 1 | 4221 13 | ■ | 1 |
| | | 500 | 4221 09 | ■ | 1 | 4221 14 | ■ | 1 |
| | | 630 | 4221 10 | ■ | 1 | 4221 15 | ■ | 1 |
| DPX ³ 1600 | 800 | 4223 60 | ■ | 1 | 4223 66 | ■ | 1 | |
| | 1000 | 4223 61 | ■ | 1 | 4223 67 | ■ | 1 | |
| | 1250 | 4223 62 | ■ | 1 | 4223 68 | ■ | 1 | |
| | 1600 | 4223 63 | ■ | 1 | 4223 69 | ■ | 1 | |
| 70 KA | DPX ³ 250 | 40 | 4206 65 | 79690 | 1 | 4206 75 | 88200 | 1 |
| | | 100 | 4206 67 | 79690 | 1 | 4206 77 | 88200 | 1 |
| | | 160 | 4206 68 | 95260 | 1 | 4206 78 | 101180 | 1 |
| | | 250 | 4206 69 | 95430 | 1 | 4206 79 | 138780 | 1 |
| | DPX ³ 630 | 320 | 4221 17 | ■ | 1 | 4221 22 | ■ | 1 |
| | | 400 | 4221 18 | ■ | 1 | 4221 23 | ■ | 1 |
| | | 500 | 4221 19 | ■ | 1 | 4221 24 | ■ | 1 |
| | | 630 | 4221 20 | ■ | 1 | 4221 25 | ■ | 1 |
| DPX ³ 1600 | 800 | 4223 72 | ■ | 1 | 4223 78 | ■ | 1 | |
| | 1000 | 4223 73 | ■ | 1 | 4223 79 | ■ | 1 | |
| | 1250 | 4223 74 | ■ | 1 | 4223 80 | ■ | 1 | |
| | 1600 | 4223 75 | ■ | 1 | 4223 81 | ■ | 1 | |

Electronic S2 + Energy Metering + Electronic Earth Leakage Module

| | | | | | | | | |
|-------|----------------------|-----|---|---|---|---------|--------|---|
| 25 KA | DPX ³ 250 | 40 | ■ | ■ | ■ | 4204 22 | 135710 | 1 |
| | | 100 | ■ | ■ | ■ | 4204 25 | 136360 | 1 |
| | | 160 | ■ | ■ | ■ | 4204 27 | 144990 | 1 |
| | | 250 | ■ | ■ | ■ | 4204 29 | 163310 | 1 |
| 36 KA | DPX ³ 250 | 40 | ■ | ■ | ■ | 4204 52 | 137450 | 1 |
| | | 100 | ■ | ■ | ■ | 4204 55 | 137630 | 1 |
| | | 160 | ■ | ■ | ■ | 4204 57 | 146160 | 1 |
| | | 250 | ■ | ■ | ■ | 4204 59 | 163880 | 1 |
| 50 KA | DPX ³ 250 | 40 | ■ | ■ | ■ | 4204 82 | 142840 | 1 |
| | | 100 | ■ | ■ | ■ | 4204 85 | 144040 | 1 |
| | | 160 | ■ | ■ | ■ | 4204 87 | 153300 | 1 |
| | | 250 | ■ | ■ | ■ | 4204 89 | 172410 | 1 |
| 70 KA | DPX ³ 250 | 40 | ■ | ■ | ■ | 4206 85 | 143880 | 1 |
| | | 100 | ■ | ■ | ■ | 4206 87 | 145190 | 1 |
| | | 160 | ■ | ■ | ■ | 4206 88 | 153770 | 1 |
| | | 250 | ■ | ■ | ■ | 4206 89 | 183050 | 1 |

* MRP - Maximum Retail Price Inclusive of all taxes including GST.
 ■ Price available on request.

Bold Cat.Nos are products normally available with Legrand (India) Stockists. Cat.Nos that are not bold - delivery within 4 - 8 weeks from the date of order. Bold packing quantity is our mandatory packing. Orders to be placed by Legrand (India) Stockist in multiples of the same.

DPX³ MCCB

DPX³ MCCB with Electronic Sg (LSIg) & Energy Metering Protection Unit

- Range: 250A – 1600A, Ics=100%Icu, Two Optimum Frames
- Protection against Overloads:
 - Ir adjustable from 0.4 to 1 x In
 - tr adjustable from 3 to 30s
- Protection against Short Circuits:
 - Isd adjustable from 1.5 to 10 x Ir
 - tsd adjustable from 0 to 0.5s
- Inbuilt Instantaneous Protection:
 - li – Fixed
- Protection against Ground Fault:
 - Ig adjustable from 0.2 to 1 In & OFF
 - tg adjustable from 0.1 to 1s
- Breaking Capacity – 36kA, 50kA, 70kA & 100kA
- Integrated energy metering with accuracy class 2
- Measure for currents, voltage, frequency, power, energy and harmonics
- Internal Battery with battery measure function
- Communication Ready via COMM Port
- Logical Selectivity Ready (Zone Selective Interlocking)
- Dynamic Selectivity as per Selectivity Charts
- In Built USB Port for Software Diagnosis
- Switchable Thermal Memory
- Suitable for Isolation

| Category | Type | Rated Current (A) | 3P | | | 4P | | |
|----------|------|-------------------|---------|-------------|------|---------|-------------|------|
| | | | Cat.Nos | MRP*/₹/Unit | Pack | Cat.Nos | MRP*/₹/Unit | Pack |

Electronic Sg + Energy Metering

| | | | | | | | | |
|-------|-----------------------|------|---------|---|---|---------|---|---|
| 36 KA | DPX ³ 630 | 320 | 4221 77 | ■ | 1 | 4221 82 | ■ | 1 |
| | | 400 | 4221 78 | ■ | 1 | 4221 83 | ■ | 1 |
| | | 500 | 4221 79 | ■ | 1 | 4221 84 | ■ | 1 |
| | | 630 | 4221 80 | ■ | 1 | 4221 85 | ■ | 1 |
| | DPX ³ 1600 | 800 | 4224 44 | ■ | 1 | 4224 50 | ■ | 1 |
| | | 1000 | 4224 45 | ■ | 1 | 4224 51 | ■ | 1 |
| | | 1250 | 4224 46 | ■ | 1 | 4224 52 | ■ | 1 |
| | | 1600 | 4224 47 | ■ | 1 | 4224 53 | ■ | 1 |
| 50 KA | DPX ³ 630 | 320 | 4221 87 | ■ | 1 | 4221 92 | ■ | 1 |
| | | 400 | 4221 88 | ■ | 1 | 4221 93 | ■ | 1 |
| | | 500 | 4221 89 | ■ | 1 | 4221 94 | ■ | 1 |
| | | 630 | 4221 90 | ■ | 1 | 4221 95 | ■ | 1 |
| | DPX ³ 1600 | 800 | 4224 56 | ■ | 1 | 4224 62 | ■ | 1 |
| | | 1000 | 4224 57 | ■ | 1 | 4224 63 | ■ | 1 |
| | | 1250 | 4224 58 | ■ | 1 | 4224 64 | ■ | 1 |
| | | 1600 | 4224 59 | ■ | 1 | 4224 65 | ■ | 1 |
| 70 KA | DPX ³ 630 | 320 | 4221 97 | ■ | 1 | 4222 02 | ■ | 1 |
| | | 400 | 4221 98 | ■ | 1 | 4222 03 | ■ | 1 |
| | | 500 | 4221 99 | ■ | 1 | 4222 04 | ■ | 1 |
| | | 630 | 4222 00 | ■ | 1 | 4222 05 | ■ | 1 |
| | DPX ³ 1600 | 800 | 4224 68 | ■ | 1 | 4224 74 | ■ | 1 |
| | | 1000 | 4224 69 | ■ | 1 | 4224 75 | ■ | 1 |
| | | 1250 | 4224 70 | ■ | 1 | 4224 76 | ■ | 1 |
| | | 1600 | 4224 71 | ■ | 1 | 4224 77 | ■ | 1 |

Switch Disconnector

| | | | | | | | |
|-----------------------|------|---------|-------|---|---------|-------|---|
| DPX ³ 160 | 160 | 4201 98 | 12980 | 1 | 4201 99 | 16310 | 1 |
| | 250 | 4202 99 | 25340 | 1 | 4203 00 | 34850 | 1 |
| DPX ³ 630 | 400 | 4222 16 | 36540 | 1 | 4222 18 | 46700 | 1 |
| | 630 | 4222 17 | 42250 | 1 | 4222 19 | 58580 | 1 |
| DPX ³ 1600 | 800 | 4224 91 | ■ | 1 | 4224 95 | ■ | 1 |
| | 1250 | 4224 92 | ■ | 1 | 4224 96 | ■ | 1 |
| | 1600 | 4224 93 | ■ | 1 | 4224 97 | ■ | 1 |

■ Price available on request.

* MRP - Maximum Retail Price Inclusive of all taxes including GST.

Bold Cat.Nos are products normally available with Legrand (India) Stockists. Cat.Nos that are not bold - delivery within 4 - 8 weeks from the date of order. Bold packing quantity is our mandatory packing. Orders to be placed by Legrand (India) Stockist in multiples of the same.

DPX³ MCCB

| Category | Type | Rated Current (A) | 3P | | | 4P | | |
|----------|------|-------------------|---------|-------------|------|---------|-------------|------|
| | | | Cat.Nos | MRP*/₹/Unit | Pack | Cat.Nos | MRP*/₹/Unit | Pack |

Only Magnetic

| | | | | | | | | |
|-------|----------------------|-----|---------|-------|---|---|---|---|
| 16 KA | DPX ³ 160 | 16 | 4207 10 | 18800 | 1 | ■ | ■ | ■ |
| | | 25 | 4207 11 | 18800 | 1 | ■ | ■ | ■ |
| | | 50 | 4207 12 | 18800 | 1 | ■ | ■ | ■ |
| | | 63 | 4207 13 | 18800 | 1 | ■ | ■ | ■ |
| 25 KA | DPX ³ 160 | 16 | 4207 14 | 21380 | 1 | ■ | ■ | ■ |
| | | 25 | 4207 15 | 21380 | 1 | ■ | ■ | ■ |
| | | 50 | 4207 16 | 21380 | 1 | ■ | ■ | ■ |
| | | 63 | 4207 17 | 21380 | 1 | ■ | ■ | ■ |
| 36 KA | DPX ³ 250 | 100 | 4207 18 | 37160 | 1 | ■ | ■ | ■ |
| | | 160 | 4207 19 | 37160 | 1 | ■ | ■ | ■ |
| | | 200 | 4207 20 | 39300 | 1 | ■ | ■ | ■ |
| | | 250 | 4207 21 | 41420 | 1 | ■ | ■ | ■ |
| 70 KA | DPX ³ 250 | 100 | 4207 22 | 36320 | 1 | ■ | ■ | ■ |
| | | 160 | 4207 23 | 36320 | 1 | ■ | ■ | ■ |
| | | 200 | 4207 24 | 38590 | 1 | ■ | ■ | ■ |
| | | 250 | 4207 25 | 40860 | 1 | ■ | ■ | ■ |

Accessories

| Type | Rotary handle | | | | Shunt release | | | | | | | | | | | |
|--|---------------|------|------------|------|---------------|------|---------|------|---------|------|---------|------|---------|------|---------|------|
| | Direct | | Vary depth | | 12 V | | 24 V | | 48 V | | 110 V | | 230 V | | 400 V | |
| | Cat.No | MRP | Cat.No | MRP | Cat.No | MRP | Cat.No | MRP | Cat.No | MRP | Cat.No | MRP | Cat.No | MRP | Cat.No | MRP |
| DPX ³ 160 DPX ³ 250 | 4201 60 | 1850 | 4201 61 | 2680 | 4210 12 | 3600 | 4210 13 | 3600 | 4210 14 | 3600 | 4210 15 | 3600 | 4210 16 | 3600 | 4210 17 | 3600 |
| DPX ³ 630 | 4201 62 | 2960 | 4201 63 | 5090 | | | | | | | | | | | | |
| DPX ³ 1600 | 0262 61 | 6200 | 0262 83 | 9520 | - | - | 4222 39 | 3830 | 4222 40 | 3570 | 4222 41 | 3570 | 4222 42 | 3830 | 4222 43 | 3830 |

| Type | U/V release | | | | | | | | | | | | | |
|---|-------------|------|---------|------|---------|------|---------|------|---------|------|---------|------|---------|------|
| | 12 V | | 24 V | | 48 V | | 110 V | | 230 V | | 400 V | | 480 V | |
| | Cat.No | MRP | Cat.No | MRP | Cat.No | MRP | Cat.No | MRP | Cat.No | MRP | Cat.No | MRP | Cat.No | MRP |
| DPX ³ 160 DPX ³ 250 | 4210 18 | 4510 | 4210 19 | 4510 | 4210 20 | 4510 | 4210 21 | 4460 | 4210 22 | 4460 | 4210 24 | 4460 | 4210 25 | 4460 |
| DPX ³ 630 DPX ³ 1600 | - | - | 4222 45 | 5060 | 4222 46 | 5060 | 4222 47 | 5020 | 4222 48 | 5380 | 4222 49 | 5380 | - | - |

| Type | Rated Current (A) | Spreaders** | | | | Motor Operator | | | | | | | | | |
|-----------------------|-------------------|---------------|-------|---------------|-------|----------------|-------|---------|-------|---------|-------|---------|-------|---------|-------|
| | | 3P (Set of 3) | | 4P (Set of 4) | | 24-230V Side | | 24V | | 48V | | 110V | | 230V | |
| | | Cat.No | MRP | Cat.No | MRP | Cat.No | MRP | Cat.No | MRP | Cat.No | MRP | Cat.No | MRP | Cat.No | MRP |
| DPX ³ 160 | | 6250 02 | 1020 | 6250 06 | 1380 | | | | | | | | | | |
| DPX ³ 250 | | 6250 14 | 1020 | 6250 18 | 1380 | 4210 60 | 50880 | 4210 61 | 45700 | 4210 61 | 45700 | 4210 61 | 45700 | 4210 61 | 45700 |
| DPX ³ 630 | Upto 400 A | 4226 31 | 2060 | 4226 32 | 2750 | | | | | | | | | | |
| | 630 A | 6250 04 | 2450 | 6250 08 | 3140 | - | - | 0261 40 | 78130 | 0261 41 | 78130 | - | - | 0261 44 | 74410 |
| DPX ³ 1600 | Upto 1250 A | 4226 24 | 14710 | 4226 25 | 17870 | - | - | 0261 24 | ■ | 0261 25 | ■ | 0261 26 | 79700 | 0261 23 | 86160 |
| | 1600 A | 0262 73 | 38340 | 0262 74 | 40440 | - | - | 0261 19 | ■ | 0261 28 | ■ | 0261 29 | ■ | 0261 27 | 81180 |

* MRP - Maximum Retail Price Inclusive of all taxes including GST.
 ■ Price available on request.

Bold Cat.Nos are products normally available with Legrand (India) Stockists.
 Cat.Nos that are not bold - delivery within 4 - 8 weeks from the date of order.
 Bold packing quantity is our mandatory packing. Orders to be placed by Legrand (India) Stockist in multiples of the same.

DPX³ 160

Equipment & Mounting Accessories

| Cat.Nos | Description | MRP* ₹ / Unit | Pack |
|---------|-------------|------------------|------|
|---------|-------------|------------------|------|

Equipment for Plug-in Version

| | | | |
|---------|--|-------|---|
| 4210 40 | For DPX ³ 160 - 3P | 30520 | 1 |
| 4210 41 | For DPX ³ 160 - 4P | 40910 | 1 |
| 4210 44 | Set of connectors for auxiliary contacts | 4370 | 1 |
| 4210 45 | Key barrel and flat key for Padlocks | 27860 | 1 |
| 4210 46 | Key barrel and star key for Padlocks | 25220 | 1 |
| 4210 47 | Padlock accessory | 7740 | 1 |

Connection Accessories

| | | | |
|---------|---|-------|---|
| 4210 26 | Set of 3 terminals for High capacity cage terminals | 11620 | 1 |
| 4210 27 | Set of 4 terminals for High capacity cage terminals | 15350 | 1 |
| 4210 70 | Set of 3 Insulated Shields/ Phase barriers | 250 | 1 |
| 4210 28 | Set of 3 terminals Screw terminals for copper bars connection | 1320 | 1 |
| 4210 29 | Set of 4 terminals Screw terminals for copper bars connection | 1370 | 1 |
| 6250 02 | Set of 3 spreaders for DPX ³ 160 3P | 1020 | 1 |
| 6250 06 | Set of 4 spreaders for DPX ³ 160 4P | 1380 | 1 |

Connection Accessories

| | | | |
|---------|---|------|---|
| 4210 36 | Set of 3 rear terminals for DPX ³ 160 3P | 6220 | 1 |
| 4210 37 | Set of 4 rear terminals for DPX ³ 160 4P | 8330 | 1 |

Sealable terminal shields

For Front Terminals

| | | | |
|---------|-----------------------------|------|---|
| 4210 54 | For DPX ³ 160 3P | 6790 | 1 |
| 4210 55 | For DPX ³ 160 3P | 7150 | 1 |

For Rear Terminals

| | | | |
|---------|-----------------------------|------|---|
| 4210 50 | For DPX ³ 160 3P | 4280 | 1 |
| 4210 51 | For DPX ³ 160 4P | 3800 | 1 |

Fixing Plates

| | | | |
|---------|--|------|---|
| 4210 71 | For DPX ³ 160 3P / 4P without earth leakage module | 620 | 1 |
| 4210 73 | For DPX ³ 160 4P with earth leakage module | 1540 | 1 |
| 4210 68 | For DPX ³ 160 3P / 4P with side mounting motor operator | 1570 | 1 |

■ Price available on request.

* MRP - Maximum Retail Price Inclusive of all taxes including GST.



4210 40



4210 36

DPX³ 160 and 250

Common Auxiliaries & Accessories

| Cat.Nos | Description | MRP* ₹ / Unit | Pack |
|---------|-------------|------------------|------|
|---------|-------------|------------------|------|

Supply Inverter Type

| | | | |
|---------|----------------------------------|------|---|
| 4210 58 | For fixed version | 5720 | 1 |
| 4210 59 | For plug-in and draw-out version | 6100 | 1 |

Rotary Handles

| | | | |
|---------|---|------|---|
| 4201 60 | Standard handle for thermal magnetic DPX ³ | 1850 | 1 |
| 4201 61 | Vari-depth standard handles | 2680 | 1 |
| 4201 67 | Key Lock for VD RH DPX ³ 160 & 250 | 3260 | 1 |
| 4201 65 | Key Lock for DIR RH Type A DPX ³ 160 & 250 | 3160 | 1 |
| 4201 68 | Key Lock for VD RH Type A DPX ³ 160 & 250 | 3260 | 1 |
| 4201 66 | Key Lock for DIR RH Type B DPX ³ 160 & 250 | 3160 | 1 |
| 4201 69 | Key Lock for VD RH Type B DPX ³ 160 & 250 | 3260 | 1 |

Motor-Driven Handles

| | | | |
|---------|--|-------|---|
| 4210 60 | Side motor operator | 50880 | 1 |
| 4210 61 | Front motor operator | 45700 | 1 |
| 4210 62 | Ronis key barrel for front motor operator | 10440 | 1 |
| 4210 63 | Profalux key barrel for front motor operator | 24800 | 1 |

DPX³ 160 and 250 common

Auxiliaries & Accessories

| | | | |
|---------|---|-------|---|
| 4210 64 | Padlock for front motor operator | 3540 | 1 |
| 4210 65 | Ronis key barrel for side motor operator | 27540 | 1 |
| 4210 66 | Profalux key barrel for side motor operator | 25020 | 1 |
| 4210 67 | Padlock for side motor operator | 3760 | 1 |

Auxiliary Contacts

| | | | |
|---------|--|------|---|
| 4210 10 | 1 N/C + 1 N/O auxiliary contact for rotary handles | 2080 | 1 |
| 4210 11 | Auxiliary contact or fault signalling contact | 1620 | 1 |
| 4210 48 | Signalling contact plugged-in/drawn-out (for DPX ³ plug-in version) | 1740 | 1 |

Locking Accessory

| | | | |
|---------|--|-------|---|
| 4210 49 | Padlock for locking in "open" position | 28420 | 1 |
|---------|--|-------|---|

Communication Interface

| | | | |
|---------|--------|-------|---|
| 4210 75 | Modbus | 23510 | 1 |
|---------|--------|-------|---|



4210 58



4210 10



4210 11

Bold Cat.Nos are products normally available with Legrand (India) Stockists. Cat.Nos that are not bold - delivery within 4 - 8 weeks from the date of order. Bold packing quantity is our mandatory packing. Orders to be placed by Legrand (India) Stockist in multiples of the same.

DPX³ 250 Equipment & Mounting Accessories

| Cat.Nos | Description | MRP* ₹ / Unit | Pack |
|---------|-------------|------------------|------|
|---------|-------------|------------------|------|

Equipment for Plug-in Version

| | | | |
|---------|--|-------|---|
| 4210 42 | For DPX ³ 250 - 3P | 34180 | 1 |
| 4210 43 | For DPX ³ 250 - 4P with or without earth leakage module | 41170 | 1 |
| 4210 44 | Set of connectors for auxiliary contacts | 4370 | 1 |
| 4210 45 | Key barrel and flat key N° ABA90GEL6149 for Padlocks | 27860 | 1 |
| 4210 46 | Key barrel and star key N° HBA90GPS6149 for Padlocks | 25220 | 1 |
| 4210 47 | Padlock accessory | 7740 | 1 |

Connection Accessories

| | | | |
|---------|-------------------------|------|---|
| 4210 30 | Set of 3 cage terminals | 4680 | 1 |
| 4210 31 | Set of 4 cage terminals | 6100 | 1 |
| 4210 70 | Set of 3 phase barriers | 250 | 1 |

Connection Accessories

| | | | |
|---------|---|------|---|
| 6250 14 | Set of 3 spreaders for DPX ³ 250 3P | 1020 | 1 |
| 6250 18 | Set of 4 spreaders for DPX ³ 250 4P | 1380 | 1 |
| 4210 38 | Set of 3 rear terminals for DPX ³ 250 3P | 6280 | 1 |
| 4210 39 | Set of 4 rear terminals for DPX ³ 250 4P | 8450 | 1 |

Sealable Terminal Shields

For Front Terminals

| | | | |
|---------|-----------------------------|------|---|
| 4210 56 | For DPX ³ 250 3P | 7020 | 1 |
| 4210 57 | For DPX ³ 250 4P | 7440 | 1 |

For Rear Terminals

| | | | |
|---------|-----------------------------|------|---|
| 4210 52 | For DPX ³ 250 3P | 4190 | 1 |
| 4210 53 | For DPX ³ 250 4P | 4610 | 1 |

Fixing Plates

| | | | |
|---------|--|------|---|
| 4210 72 | For DPX ³ 250 3P / 4P without earth leakage module | 620 | 1 |
| 4210 74 | For DPX ³ 250 4P with earth leakage module | 2660 | 1 |
| 4210 69 | For DPX ³ 250 3P / 4P with side mounting motor operator | 1560 | 1 |

DPX³ 630 Equipment & Accessories

Plug-in Version

| | | | |
|---------|---|------|---|
| 4222 20 | Set of incoming and outgoing terminals - 3P (6 terminals for 3P DPX ³ or 8 terminals for 4P DPX ³) | 5570 | 1 |
|---------|---|------|---|

DPX³ 630 Equipment & Accessories

| Cat.Nos | Description | MRP* ₹ / Unit | Pack |
|---------|-------------|------------------|------|
|---------|-------------|------------------|------|

Plug-in Version

| | | | |
|---------|---|-------|---|
| 4222 21 | Set of incoming and outgoing terminals - 4P (6 terminals for 3P DPX ³ or 8 terminals for 4P DPX ³) | 6500 | 1 |
| 4222 22 | Front terminal mounting base for DPX ³ only - 3P | 12980 | 1 |
| 4222 24 | Flat rear terminal mounting base for DPX ³ only - 3P | 20220 | 1 |
| 4222 23 | Front terminal mounting base for DPX ³ only - 4P | 16250 | 1 |
| 4222 25 | Flat rear terminal mounting base for DPX ³ only - 4P | 40120 | 1 |
| 4222 26 | Front terminal mounting base for DPX ³ with earth leakage module - 4 P | ■ | 1 |
| 4222 27 | Flat rear terminal mounting base for DPX ³ with earth leakage module - 4P | ■ | 1 |
| 4222 37 | For fixing the signalling contact - 4P Cat.No 0265 74 on a DPX ³ plug-in version | 4320 | 1 |
| 4222 28 | Set of 2 extractor handle | 6060 | 1 |
| 4222 29 | Set of connectors (24-pin) | 3400 | 1 |

Draw-out Version

| | | | |
|---------|--|-------|---|
| 4222 31 | "Debro-lift" mechanism for DPX ³ base only - 3P | 39860 | 1 |
| 4222 32 | "Debro-lift" mechanism for DPX ³ base only - 4P | 41740 | 1 |
| 4222 33 | "Debro-lift" mechanism for DPX ³ base with elm - 4P | ■ | 1 |
| 0265 76 | One key for "Debro-lift" mechanism for DPX ³ only - Flat key | ■ | 1 |
| 0265 78 | Two keys (one key supplied) for "Debro-lift" mechanism for motorised DPX ³ or with rotary handle - Flat key | ■ | 1 |
| 0263 48 | One key for "Debro-lift" mechanism for DPX ³ only - Star key | ■ | 1 |
| 0265 77 | Two keys (one key supplied) for motorised DPX ³ or with rotary handle - Star key | ■ | 1 |
| 0265 75 | Handle for drawing-out for "Debro-lift" mechanism | 6400 | 1 |
| 0265 74 | Signalling contact (plugged-in/drawn-out) for "Debro-lift" mechanism | 4360 | 1 |
| 4222 36 | For fixing the signalling contact Cat.No 0265 74 on a DPX ³ draw-out version | 4360 | 1 |

■ Price available on request.

* MRP - Maximum Retail Price inclusive of all taxes including GST.

Bold Cat.Nos are products normally available with Legrand (India) Stockists. Cat.Nos that are not bold - delivery within 4 - 8 weeks from the date of order. Bold packing quantity is our mandatory packing. Orders to be placed by Legrand (India) Stockist in multiples of the same.

DPX³ 630 Equipment & Accessories

| Cat.Nos | Description | MRP* ₹ / Unit | Pack |
|---------|-------------|------------------|------|
|---------|-------------|------------------|------|

Draw-out Version

| | | | |
|---------|---|------|---|
| 4222 30 | Block of 6 automatic auxiliary contacts for DPX ³ draw-out version (up to 2 blocks by DPX ³) | 1660 | 1 |
|---------|---|------|---|

Supply inverter type

| | | | |
|---------|---|-------|---|
| 0264 09 | Plate for MCCB or trip-free switch fixed version | 13930 | 1 |
| 0264 04 | Plate for MCCB or trip-free switch plug-in and draw-out version | 18800 | 1 |

Rotary Handles

| | | | |
|---------|--|------|---|
| 4201 62 | Direct rotary handle | 2960 | 1 |
| 4201 63 | Vari-depth rotary handle | 5090 | 1 |
| 4201 70 | Key Lock for VD RH DPX ³ 630 | 3540 | 1 |
| 4201 71 | Key Lock for VD RH Type A DPX ³ 630 | 3540 | 1 |
| 4201 72 | Key Lock for VD RH Type B DPX ³ 630 | 3540 | 1 |

Motor-Driven Handles

| | | | |
|---------|------------------------|-------|---|
| 0261 40 | Front operated 24 V~/= | 78130 | 1 |
| 0261 41 | Front operated 48 V~/= | 78130 | 1 |
| 0261 44 | Front operated 230 V~ | 74410 | 1 |
| 422806 | Lock and flat key | ■ | 1 |
| 0261 58 | Lock and star key | 19980 | 1 |

Accessories

| | | | |
|---------|--|-------|---|
| 0262 30 | Set of 3 Insulated Shields/ Phase barriers | 310 | 1 |
| 0262 44 | Set of 2 sealable terminal shields - 3P | 8664 | 1 |
| 0262 45 | Set of 2 sealable terminal shields - 4P | 2420 | 1 |
| 0262 40 | Padlock for locking in "OPEN" position - 4P | 3130 | 1 |
| 0262 46 | Set of 4 adaptors + Insulated Shields/ Phase barriers for lug - 4P | ■ | 1 |
| 0262 47 | Set of 4 extended front terminals-4P | 8570 | 1 |
| 6250 04 | Set of incoming or outgoing spreaders - 3P | 2450 | 1 |
| 6250 08 | Set of incoming or outgoing spreaders - 4P | 3140 | 1 |
| 0263 50 | Set of incoming or outgoing swivel rear terminals - 3P | ■ | 1 |
| 0263 52 | Set of incoming or outgoing flat rear terminals - 3P | 27660 | 1 |
| 0263 51 | Set of incoming or outgoing swivel terminals - 4P | ■ | 1 |
| 0263 53 | Set of incoming or outgoing flat terminals - 4P | 23490 | 1 |
| 4222 34 | Set of 2 IP 20 terminal covers - 3P | 1850 | 1 |
| 4222 35 | Set of 2 IP 20 terminal covers - 4P | 6410 | 1 |



0261 40



6250 04



4222 34



4222 35

■ Price available on request.

* MRP - Maximum Retail Price Inclusive of all taxes including GST.

DPX³ 630 Earth Leakage Module

| Type and frame size | Rated Current (A) | Poles | Cat.Nos | MRP* ₹ / Unit | Pack |
|---------------------|-------------------|-------|---------|------------------|------|
|---------------------|-------------------|-------|---------|------------------|------|

Earth Leakage Module

Standard

| | | | | | |
|----------------------|-------|--------|---------|-------|---|
| DPX ³ 630 | 400 A | 3 Pole | 0260 60 | 50430 | 1 |
| | 630 A | 3 Pole | 0260 64 | 94510 | 1 |
| | 400 A | 4 Pole | 0260 61 | 89090 | 1 |
| | 630 A | 4 Pole | 0260 65 | 93900 | 1 |

LED Version

| | | | | | |
|----------------------|-------|--------|---------|-------|---|
| DPX ³ 630 | 400 A | 4 Pole | 0260 63 | ■ | 1 |
| | 630 A | 4 Pole | 0260 67 | 92000 | 1 |

DPX³ 1600 Equipment & Accessories

| Cat.Nos | Description | MRP* ₹ / Unit | Pack |
|---------|-------------|------------------|------|
|---------|-------------|------------------|------|

Draw-out Version

| | | | |
|---------|---|------|---|
| 4225 86 | Front terminals - 3P | ■ | 1 |
| 4225 88 | Rear terminals - 3P | ■ | 1 |
| 4225 87 | Front terminals - 4P | ■ | 1 |
| 4225 89 | Rear terminals - 4P | ■ | 1 |
| 4225 93 | Debro-lift mechanism For DPX ³ 1600 - 3P | ■ | 1 |
| 4225 94 | Debro-lift mechanism for DPX ³ 1600 - 4P | ■ | 1 |
| 4225 95 | For fixing the signalling contact Cat.No 0265 74 on a DPX ³ draw-out version | ■ | 1 |
| 0265 76 | One key for "Debro-lift" mechanism for DPX ³ only - Flat key | ■ | 1 |
| 0265 80 | Two key (one key supplied) for motorised DPX ³ or with rotary handle | ■ | 1 |
| 0263 48 | One key for DPX ³ only - Starkey | ■ | 1 |
| 0265 79 | Two key (one key supplied) for motorised DPX ³ or with rotary handle | ■ | 1 |
| 0265 75 | Handle for drawing-out for "Debro-lift" mechanism | 6400 | 1 |
| 0265 74 | Signalling contact (plugged-in/drawn-out) | 4360 | 1 |
| 4222 30 | Block of 6 automatic auxiliary contacts for DPX ³ draw-out version (up to 2 blocks by DPX ³) | 1660 | 1 |



4225 88
+
4225 93

Bold Cat.Nos are products normally available with Legrand (India) Stockists. Cat.Nos that are not bold - delivery within 4 - 8 weeks from the date of order. Bold packing quantity is our mandatory packing. Orders to be placed by Legrand (India) Stockist in multiples of the same.

DPX³ 1600

Equipment & Accessories

| Cat.Nos | Description | MRP* ₹ / Unit | Pack |
|---------|-------------|------------------|------|
|---------|-------------|------------------|------|

Supply Inverter Type

| | | | |
|---------|--|-------|---|
| 0264 10 | Plate for MCCBs or trip-free switch fixed version | 16880 | 1 |
| 0264 05 | Plate for MCCBs or trip-free switch plug-in and draw-out version | ■ | 1 |

Rotary Handles

| | | | |
|---------|---|-------|---|
| 0262 61 | Standard (black) direct on DPX ³ | 6200 | 1 |
| 0262 83 | Standard (black) vari-depth handle IP 55 | 9520 | 1 |
| 0262 93 | Key barrel and flat key | 3530 | 1 |
| 0262 94 | Key barrel and star key | 18200 | 1 |

Motor-Driven Handles

| | | | |
|---------|--|--------|---|
| 0261 54 | Front operated 230 V± | 101280 | 1 |
| 0261 24 | Front operated 24 V±/= for In ≤ 1250 A | ■ | 1 |
| 0261 25 | Front operated 48 V±/= for In ≤ 1250 A | ■ | 1 |

Motor-Driven Handles

| | | | |
|---------|---|-------|---|
| 0261 26 | Front operated 110 V±/= for In ≤ 1250 A | 79700 | 1 |
| 0261 23 | Front operated 230 V±/= for In ≤ 1250 A | 86160 | 1 |
| 0261 19 | Front operated 24 V±/= for In = 1600 A | ■ | 1 |
| 0261 28 | Front operated 48 V±/= for In = 1600 A | ■ | 1 |
| 0261 29 | Front operated 110 V±/= for In = 1600 A | ■ | 1 |
| 0261 27 | Front operated 230 V±/= for In = 1600 A | 81180 | 1 |
| 4228 06 | Mech Support DPX ³ 630/1600 Key lock | 10990 | 1 |
| 0261 58 | Key and star key | 19980 | 1 |

Accessories

| | | | |
|---------|---|------|---|
| 0262 66 | Set of 3 Insulated Shields/ Phase barriers | 600 | 1 |
| 0262 64 | Set of 2 sealable terminal shields - 3P | ■ | 1 |
| 0262 65 | Set of 2 sealable terminal shields - 4P | 3250 | 1 |
| 0262 60 | Padlock for locking in "open" position | 2810 | 1 |
| 0262 67 | Set of 4 extended front short terminals for 630 - 1250 A (2 bars max. per pole) | ■ | 1 |



0262 60

■ Price available on request.

* MRP - Maximum Retail Price Inclusive of all taxes including GST.

DPX³ 630 and 1600

Common Auxiliaries

| Cat.Nos | Description | MRP* ₹ / Unit | Pack |
|---------|-------------|------------------|------|
|---------|-------------|------------------|------|

Accessories

| | | | |
|---------|--|-------|---|
| 0262 68 | Set of 4 extended front Long terminals for 1600 A (3 bars max. per pole) | 27690 | 1 |
| 4226 24 | Set of incoming or outgoing spreaders for 800 A & 1000 A - 3P | 14710 | 1 |
| 4226 25 | Set of incoming or outgoing spreaders for 800 A & 1000 A - 4P | 17870 | 1 |
| 0262 73 | Set of incoming or outgoing spreaders for 1250 A & 1600 A - 3P | 38340 | 1 |
| 0262 74 | Set of incoming or outgoing spreaders for 1250 A & 1600 A - 4P | 40440 | 1 |
| 0263 80 | Short rear terminals - 3P | ■ | 1 |
| 0263 81 | Long rear terminals - 3P | ■ | 1 |
| 0263 82 | Short rear terminals - 4P | ■ | 1 |
| 0263 83 | Long rear terminals - 4P | ■ | 1 |
| 4225 90 | Set of 2 IP 20 terminal covers - 3P | 2050 | 1 |
| 4225 91 | Set of 2 IP 20 terminal covers - 4P | 3330 | 1 |
| 4225 92 | External neutral - 4P | 21750 | 1 |



0262 67 + 0262 68

Common Auxiliaries

| | | | |
|---------|---|------|---|
| 4210 11 | For signalling the state of the contacts or opening of the MCCB on a fault For DPX ³ /DPX ³ -I Changeover switch 3 A - 240 V± | 1620 | 1 |
|---------|---|------|---|

Releases

Allow remote tripping of a DPX³

Time-lag undervoltage releases (800 ms)

Prevent false tripping in the event of power supply microbreaks.

Require a time-lag module connected to the undervoltage release Cat.No 4226 23

| | | | |
|---------|---------------------------------|---|---|
| 0261 90 | Time-lag module 230 VA 3 module | ■ | 1 |
|---------|---------------------------------|---|---|

Bold Cat.Nos are products normally available with Legrand (India) Stockists. Cat.Nos that are not bold - delivery within 4 - 8 weeks from the date of order. Bold packing quantity is our mandatory packing. Orders to be placed by Legrand (India) Stockist in multiples of the same.

DPX³ 630 and 1600

Common Auxiliaries

| Cat.Nos | Description | MRP* ₹ / Unit | Pack |
|---------|-------------|---------------------|------|
|---------|-------------|---------------------|------|

Releases

| | | | |
|---------|---|---|---|
| 0261 91 | Time-lag module 400 VA | ■ | 1 |
| 4226 23 | Undervoltage release for DPX ³ 630 and 1600 | ■ | 1 |

Auto Transfer Controller

| | | | |
|---------|----------------------|-------|---|
| 4226 81 | Standard unit | 45720 | 1 |
| 4226 82 | Advanced unit | 53350 | 1 |
| 4226 89 | Communication module | 14300 | 1 |



4226 82



0260 88

Residual Current Relay

| | | | |
|---------|--|-------|---|
| 0260 88 | Residual current relay to clip on module 2 rail | 31960 | 1 |
|---------|--|-------|---|

Current Transformer

| | | | |
|---------|---------------------|-------|---|
| 0260 92 | Coil Ø35 mm | 17450 | 1 |
| 0260 93 | Coil Ø80 mm | 25460 | 1 |
| 0260 94 | Coil Ø110 mm | 39250 | 1 |
| 0260 95 | Coil Ø140 mm | 41300 | 1 |
| 0260 96 | Coil Ø210 mm | 70450 | 1 |
| 0260 97 | Coil Ø150 mm - open | ■ | 1 |
| 0260 98 | Coil Ø300 mm - open | ■ | 1 |



0260 93
coil for use
with relay



0260 98

Metal One Way Enclosures for MCCB

| Cat.Nos | Description | No. of modules | MRP* ₹ / Unit | Pack |
|---------|-------------|-------------------|---------------------|------|
|---------|-------------|-------------------|---------------------|------|

| | | | | |
|---------|--|-----|-------|---|
| 5078 01 | DPX ³ 160 MCCB enclosure | 3&4 | 6242 | 1 |
| 5078 02 | DPX ³ 250 MCCB enclosure | 3&4 | 10976 | 1 |
| 5078 04 | DPX ³ 630 MCCB enclosure | 3&4 | 17050 | 1 |

■ Price available on request.

* MRP - Maximum Retail Price Inclusive of all taxes including GST.

DRX

MCCB RANGE

Powerful Protection, Compact Design Engineered for Enduring Safety



The DRX MCCB range delivers dependable circuit protection with a robust design and a wide range of accessories. Engineered for efficiency and affordability, it offers adjustable protection settings and advanced safety features to safeguard electrical installations across industrial and commercial applications up to 630A.

Features

- Accurate performance at higher temperatures with no deration up to 50°C
- Adjustable protection settings with overload and pre-alarm indication
- Integrated contact module for status indication and monitoring
- In-built neutral protection available in 4-pole configuration

Benefits

- Ensures reliable circuit protection even in demanding environments
- Enables flexible configuration for different electrical protection needs
- Improves monitoring and operational visibility of electrical systems
- Provides enhanced safety and protection for electrical installations



A COMPREHENSIVE RANGE

The robust design of DRX MCCB offer adjustable protection, different accessories for connection and remote tripping. They are the ideal choice in terms of efficiency and affordability for protection of your electrical installations of up to 630A.



QCO Certified

Scan to know more about the product.



DRX MCCB

DRX MCCB with Thermal Magnetic Protection Unit

Range – 16A to 630A

Ics = 100% Icu

Thermal Adjustable – 0.8 to 1 In

Magnetic Setting – 10 In for DRX125HP

Magnetic Setting – Adjustable 5 to 10 In for DRX250HP and DRX630

Suitable for Isolation

| Category | Type | Rated Current (A) | 3P | | | 4P | | |
|----------|------|-------------------|---------|-------------|------|---------|-------------|------|
| | | | Cat.Nos | MRP*/₹/Unit | Pack | Cat.Nos | MRP*/₹/Unit | Pack |

Thermal Magnetic : O/L & S/C Protection

| | | | | | | | | |
|-------|-----------------------|-----|---------|-------|---|---------|-------|---|
| 25 KA | DRX 125 ^{HP} | 16 | 6697 00 | 10260 | 1 | 6697 10 | 14270 | 1 |
| | | 20 | 6697 01 | 10260 | 1 | 6697 11 | 14270 | 1 |
| | | 25 | 6697 02 | 10260 | 1 | 6697 12 | 14270 | 1 |
| | | 32 | 6697 03 | 10260 | 1 | 6697 13 | 14270 | 1 |
| | | 40 | 6697 04 | 10260 | 1 | 6697 14 | 14270 | 1 |
| | | 50 | 6697 05 | 10260 | 1 | 6697 15 | 14270 | 1 |
| | | 63 | 6697 06 | 10260 | 1 | 6697 16 | 14270 | 1 |
| | | 80 | 6697 07 | 10260 | 1 | 6697 17 | 14270 | 1 |
| | | 100 | 6697 08 | 10260 | 1 | 6697 18 | 14270 | 1 |
| | | 125 | 6697 09 | 15200 | 1 | 6697 19 | 18030 | 1 |
| 36 KA | DRX 125 ^{HP} | 16 | 6697 20 | 13360 | 1 | 6697 30 | 16660 | 1 |
| | | 20 | 6697 21 | 13360 | 1 | 6697 31 | 16660 | 1 |
| | | 25 | 6697 22 | 13360 | 1 | 6697 32 | 16660 | 1 |
| | | 32 | 6697 23 | 13360 | 1 | 6697 33 | 16660 | 1 |
| | | 40 | 6697 24 | 13360 | 1 | 6697 34 | 16660 | 1 |
| | | 50 | 6697 25 | 13360 | 1 | 6697 35 | 16660 | 1 |
| | | 63 | 6697 26 | 13360 | 1 | 6697 36 | 16660 | 1 |
| | | 80 | 6697 27 | 13360 | 1 | 6697 37 | 16660 | 1 |
| | | 100 | 6697 28 | 13360 | 1 | 6697 38 | 16660 | 1 |
| | | 125 | 6697 29 | 15380 | 1 | 6697 39 | 19400 | 1 |
| 50 KA | DRX 125 ^{HP} | 16 | 6697 40 | 17080 | 1 | 6697 50 | 21520 | 1 |
| | | 20 | 6697 41 | 17080 | 1 | 6697 51 | 21520 | 1 |
| | | 25 | 6697 42 | 17080 | 1 | 6697 52 | 21520 | 1 |
| | | 32 | 6697 43 | 17080 | 1 | 6697 53 | 21520 | 1 |
| | | 40 | 6697 44 | 17080 | 1 | 6697 54 | 21520 | 1 |
| | | 50 | 6697 45 | 17080 | 1 | 6697 55 | 21520 | 1 |
| | | 63 | 6697 46 | 17080 | 1 | 6697 56 | 21520 | 1 |
| | | 80 | 6697 47 | 17080 | 1 | 6697 57 | 21520 | 1 |
| | | 100 | 6697 48 | 17080 | 1 | 6697 58 | 21520 | 1 |
| | | 125 | 6697 49 | 22380 | 1 | 6697 59 | 25780 | 1 |

* MRP - Maximum Retail Price Inclusive of all taxes including GST.

Bold Cat.Nos are products normally available with Legrand (India) Stockists. Cat.Nos that are not bold - delivery within 4 - 8 weeks from the date of order. Bold packing quantity is our mandatory packing. Orders to be placed by Legrand (India) Stockist in multiples of the same.

DRX MCCB

DRX MCCB with Thermal Magnetic Protection Unit

| Category | Type | Rated Current (A) | 3P | | | 4P | | |
|----------|------|-------------------|---------|-------------|------|---------|-------------|------|
| | | | Cat.Nos | MRP*/₹/Unit | Pack | Cat.Nos | MRP*/₹/Unit | Pack |

Thermal Magnetic : O/L & S/C Protection

| | | | | | | | | | |
|-------|-----------------------|---------|---------|---------|---------|---------|---------|-------|---|
| 25 KA | DRX 250 ^{HP} | 16 | 6690 00 | ■ | 1 | 6690 20 | ■ | 1 | |
| | | 20 | 6690 01 | ■ | 1 | 6690 21 | ■ | 1 | |
| | | 25 | 6690 02 | ■ | 1 | 6690 22 | ■ | 1 | |
| | | 32 | 6690 03 | ■ | 1 | 6690 23 | ■ | 1 | |
| | | 40 | 6690 04 | 15500 | 1 | 6690 24 | 18890 | 1 | |
| | | 50 | 6690 05 | 15500 | 1 | 6690 25 | 18890 | 1 | |
| | | 63 | 6690 06 | 15500 | 1 | 6690 26 | 18890 | 1 | |
| | | 80 | 6690 07 | 15500 | 1 | 6690 27 | 18890 | 1 | |
| | | 100 | 6690 08 | 16320 | 1 | 6690 28 | 19830 | 1 | |
| | | 125 | 6690 09 | 17230 | 1 | 6690 29 | 21310 | 1 | |
| | | 160 | 6690 10 | 21750 | 1 | 6690 30 | 25230 | 1 | |
| | | 200 | 6690 11 | 24760 | 1 | 6690 31 | 30350 | 1 | |
| 250 | 6690 12 | 28800 | 1 | 6690 32 | 34450 | 1 | | | |
| 36 KA | DRX 250 ^{HP} | 16 | 6690 40 | ■ | 1 | 6690 60 | ■ | 1 | |
| | | 20 | 6690 41 | ■ | 1 | 6690 61 | ■ | 1 | |
| | | 25 | 6690 42 | ■ | 1 | 6690 62 | ■ | 1 | |
| | | 32 | 6690 43 | ■ | 1 | 6690 63 | ■ | 1 | |
| | | 40 | 6690 44 | 15970 | 1 | 6690 64 | 19680 | 1 | |
| | | 50 | 6690 45 | 15970 | 1 | 6690 65 | 19680 | 1 | |
| | | 63 | 6690 46 | 15970 | 1 | 6690 66 | 19680 | 1 | |
| | | 80 | 6690 47 | 15970 | 1 | 6690 67 | 19680 | 1 | |
| | | 100 | 6690 48 | 16770 | 1 | 6690 68 | 20640 | 1 | |
| | | 125 | 6690 49 | 18830 | 1 | 6690 69 | 22090 | 1 | |
| | | 160 | 6690 50 | 21980 | 1 | 6690 70 | 25560 | 1 | |
| | | 200 | 6690 51 | 27200 | 1 | 6690 71 | 35130 | 1 | |
| | 250 | 6690 52 | 31140 | 1 | 6690 72 | 37520 | 1 | | |
| | | DRX 630 | 320 | 6676 50 | 38380 | 1 | 6676 54 | 46740 | 1 |
| | | | 400 | 6676 51 | 38380 | 1 | 6676 55 | 47610 | 1 |
| | | | 500 | 6676 52 | 49470 | 1 | 6676 56 | 62260 | 1 |
| | 630 | | 6676 53 | 49470 | 1 | 6676 57 | 65230 | 1 | |



6676 51

■ Price available on request.

* MRP - Maximum Retail Price Inclusive of all taxes including GST.

Bold Cat.Nos are products normally available with Legrand (India) Stockists. Cat.Nos that are not bold - delivery within 4 - 8 weeks from the date of order. Bold packing quantity is our mandatory packing. Orders to be placed by Legrand (India) Stockist in multiples of the same.

DRX MCCB

DRX MCCB with Thermal Magnetic Protection Unit

| Category | Type | Rated Current (A) | 3P | | | 4P | | |
|----------|------|-------------------|---------|-------------|------|---------|-------------|------|
| | | | Cat.Nos | MRP*/₹/Unit | Pack | Cat.Nos | MRP*/₹/Unit | Pack |

Thermal Magnetic : O/L & S/C Protection

| | | | | | | | | |
|-------|-----------------------|-------|---------|-------|---------|---------|-------|---------|
| 50 KA | DRX 250 ^{HP} | 16 | 6690 80 | ■ | 1 | 6691 00 | ■ | 1 |
| | | 20 | 6690 81 | ■ | 1 | 6691 01 | ■ | 1 |
| | | 25 | 6690 82 | ■ | 1 | 6691 02 | ■ | 1 |
| | | 32 | 6690 83 | ■ | 1 | 6691 03 | ■ | 1 |
| | | 40 | 6690 84 | 22540 | 1 | 6691 04 | 27090 | 1 |
| | | 50 | 6690 85 | 22540 | 1 | 6691 05 | 27120 | 1 |
| | | 63 | 6690 86 | 22540 | 1 | 6691 06 | 27120 | 1 |
| | | 80 | 6690 87 | 22540 | 1 | 6691 07 | 27120 | 1 |
| | | 100 | 6690 88 | 23670 | 1 | 6691 08 | 28470 | 1 |
| | | 125 | 6690 89 | 24550 | 1 | 6691 09 | 29560 | 1 |
| | | 160 | 6690 90 | 27430 | 1 | 6691 10 | 31950 | 1 |
| | | 200 | 6690 91 | 33170 | 1 | 6691 11 | 41270 | 1 |
| | | 250 | 6690 92 | 35660 | 1 | 6691 12 | 43920 | 1 |
| | | 50 KA | DRX 630 | 320 | 6676 58 | 42250 | 1 | 6676 62 |
| 400 | 6676 59 | | | 42250 | 1 | 6676 63 | 53140 | 1 |
| 500 | 6676 60 | | | 59850 | 1 | 6676 64 | 74770 | 1 |
| 630 | 6676 61 | | | 59850 | 1 | 6676 65 | 74770 | 1 |



6690 92



6676 61

DRX MCCB

DRX MCCB with Electronic S2 (LSI) Protection Unit

- Range: 40A – 630A, Ics=100%Icu, Two Optimum Frames
- Protection against overloads:
 - Ir adjustable from 0.4 to 1 x In
 - tr adjustable from 3 to 30s#
- Protection against short circuits:
 - I_{sd} adjustable from 1.5 to 10 x Ir
 - t_{sd} adjustable from 0 to 0.5s
- Inbuilt Instantaneous Protection:
 - I_{i#} – Fixed
- Overload Alarm Indication - I > 1.05 Ir
- Pre-Overload Alarm Indication - I > 0.9 Ir
- Over temperature Alarm Indication - T > 90 °C
- Integrated Contact Module (On/Off/ Trip) for DRX 250HP Electronic MCCBs
- Suitable for Isolation

| Category | Type | Rated Current (A) | 3P | | | 4P | | |
|----------|------|-------------------|---------|-------------|------|---------|-------------|------|
| | | | Cat.Nos | MRP*/₹/Unit | Pack | Cat.Nos | MRP*/₹/Unit | Pack |

Electronic S2

| | | | | | | | | | |
|-------|-----------------------|---------|---------|---------|-------|---------|---------|-------|---|
| 36 KA | DRX 250 ^{HP} | 40 | 6691 70 | 23550 | 1 | 6691 80 | 29930 | 1 | |
| | | 100 | 6691 71 | 23550 | 1 | 6691 81 | 29930 | 1 | |
| | | 160 | 6691 72 | 30140 | 1 | 6691 82 | 42160 | 1 | |
| | | 250 | 6691 73 | 41370 | 1 | 6691 83 | 56450 | 1 | |
| | 36 KA | DRX 630 | 320 | 6699 01 | 53390 | 1 | 6699 06 | 65760 | 1 |
| | | | 400 | 6699 02 | 53390 | 1 | 6699 07 | 65760 | 1 |
| | | | 630 | 6699 04 | 59960 | 1 | 6699 09 | 78530 | 1 |

* MRP - Maximum Retail Price Inclusive of all taxes including GST.
 ■ Price available on request.

Bold Cat.Nos are products normally available with Legrand (India) Stockists. Cat.Nos that are not bold - delivery within 4 - 8 weeks from the date of order. Bold packing quantity is our mandatory packing. Orders to be placed by Legrand (India) Stockist in multiples of the same.

DRX MCCB

DRX MCCB with Electronic S2 (LSI) Protection Unit

Electronic S2

| | | | | | | | | |
|-------|-----------------------|---------|---------|-------|---------|---------|-------|---|
| 50 KA | DRX 250 ^{HP} | 40 | 6691 90 | 28380 | 1 | 6692 00 | 39190 | 1 |
| | | 100 | 6691 91 | 28380 | 1 | 6692 01 | 39190 | 1 |
| | | 160 | 6691 92 | 36870 | 1 | 6692 02 | 48320 | 1 |
| | | 250 | 6691 93 | 47060 | 1 | 6692 03 | 60280 | 1 |
| | DRX 630 | 320 | 6699 11 | 58410 | 1 | 6699 16 | 74470 | 1 |
| | | 400 | 6699 12 | 58410 | 1 | 6699 17 | 74470 | 1 |
| 630 | | 6699 14 | 64800 | 1 | 6699 19 | 82970 | 1 | |

DRX MCCB

DRX MCCB with Electronic Sg (LSIg) Protection Unit

- Range: 40A – 630A, Ics=100%Icu, Two Optimum Frames
- Protection against overloads:
 - Ir adjustable from 0.4 to 1 x In
 - tr adjustable from 3 to 30s#
- Protection against short circuits:
 - I_{sd} adjustable from 1.5 to 10 x Ir
 - t_{sd} adjustable from 0 to 0.5s
- Inbuilt Instantaneous Protection:
 - I_{i#} – Fixed
- Protection against Ground Fault:
 - I_g adjustable from 0.2 to 1 In & OFF
 - t_g adjustable from 0.1 to 1s
- Overload Alarm Indication - I > 1.05 Ir
- Pre-Overload Alarm Indication - I > 0.9 Ir
- Over temperature Alarm Indication - T > 90 °C
- Integrated Contact Module (On/Off/ Trip) for DRX 250HP Electronic MCCBs
- Suitable for Isolation

| Category | Type | Rated Current (A) | 3P | | | 4P | | |
|----------|------|-------------------|---------|-------------|------|---------|-------------|------|
| | | | Cat.Nos | MRP*/₹/Unit | Pack | Cat.Nos | MRP*/₹/Unit | Pack |

Electronic Sg

| | | | | | | | | |
|-------|-----------------------|---------|---------|-------|---------|---------|-------|---|
| 36 KA | DRX 250 ^{HP} | 40 | 6691 75 | 42600 | 1 | 6691 85 | 49520 | 1 |
| | | 100 | 6691 76 | 42600 | 1 | 6691 86 | 49520 | 1 |
| | | 160 | 6691 77 | 48530 | 1 | 6691 87 | 59420 | 1 |
| | | 250 | 6691 78 | 57450 | 1 | 6691 88 | 71300 | 1 |
| | DRX 630 | 320 | 6699 21 | 72500 | 1 | 6699 26 | 83420 | 1 |
| | | 400 | 6699 22 | 72500 | 1 | 6699 27 | 83420 | 1 |
| 630 | | 6699 24 | 78450 | 1 | 6699 29 | 97040 | 1 | |
| 50 KA | DRX 250 ^{HP} | 40 | 6691 95 | 46550 | 1 | 6692 05 | 55200 | 1 |
| | | 100 | 6691 96 | 46550 | 1 | 6692 06 | 55200 | 1 |
| | | 160 | 6691 97 | 55460 | 1 | 6692 07 | 65860 | 1 |
| | | 250 | 6691 98 | 62400 | 1 | 6692 08 | 73610 | 1 |
| | DRX 630 | 320 | 6699 31 | 75030 | 1 | 6699 36 | 90540 | 1 |
| | | 400 | 6699 32 | 75030 | 1 | 6699 37 | 90540 | 1 |
| 630 | | 6699 34 | 80980 | 1 | 6699 39 | 101000 | 1 | |



6691 98

* MRP - Maximum Retail Price Inclusive of all taxes including GST.

Bold Cat.Nos are products normally available with Legrand (India) Stockists. Cat.Nos that are not bold - delivery within 4 - 8 weeks from the date of order. Bold packing quantity is our mandatory packing. Orders to be placed by Legrand (India) Stockist in multiples of the same.

Accessories

| Type | Rotary handle | | | | | |
|-----------|---------------|------|------|------------|------|------|
| | Direct | | | Vary depth | | |
| | Cat.No | MRP | Pack | Cat.No | MRP | Pack |
| DRX 125HP | 6687 70 | 1530 | 1 | 6687 71 | 2330 | 1 |
| DRX 250HP | 6687 72 | 1550 | 1 | 6687 73 | 2420 | 1 |
| DRX 630 | 6687 80 | 2750 | 1 | 6687 81 | 4530 | 1 |



0271 54



4222 42

| Type | Shunt release | | | | | |
|-----------|---------------|------|------|---------|------|------|
| | 240V AC | | | 415V AC | | |
| | Cat.No | MRP | Pack | Cat.No | MRP | Pack |
| DRX 125HP | 0271 54 | 2880 | 1 | 0271 55 | 2880 | 1 |
| DRX 250HP | | | | | | |
| DRX 630 | 4222 42 | ■ | 1 | 4222 43 | ■ | 1 |



0271 65

| Type | Undervoltage | | | | | |
|-----------|--------------|------|------|---------|------|------|
| | 240V AC | | | 415V AC | | |
| | Cat.No | MRP | Pack | Cat.No | MRP | Pack |
| DRX 125HP | 0271 64 | 3990 | 1 | 0271 65 | 3990 | 1 |
| DRX 250HP | | | | | | |
| DRX 630 | 4222 48 | ■ | 1 | 4222 49 | ■ | 1 |

| Type | Rated Current (A) | Spreaders | | | | | |
|-----------|-------------------|-------------|------|------|-------------|------|------|
| | | 3P One Side | | | 4P One Side | | |
| | | Cat.No | MRP | Pack | Cat.No | MRP | Pack |
| DRX 125HP | 125A | 6250 10 | 330 | 1 | 6250 11 | 480 | 1 |
| DRX 250HP | 250A | 6250 14 | 1020 | 1 | 6250 18 | 1380 | 1 |
| DRX 630 | 400A | 4226 31 | 2060 | 1 | 4226 32 | 2750 | 1 |
| | 630A | 6250 04 | 2450 | 1 | 6250 08 | 3140 | 1 |

| Type | Rated Current (A) | Phase Barriers | | | | | |
|-----------|-------------------|----------------|-----|------|-------------|-----|------|
| | | 3P One Side | | | 4P One Side | | |
| | | Cat.No | MRP | Pack | Cat.No | MRP | Pack |
| DRX 125HP | 125A | 6693 00 | 210 | 1 | 6693 01 | 260 | 1 |
| DRX 250HP | 250A | | | | | | |
| DRX 630 | 400A | 0262 30 | 310 | 1 | 0262 30 | 310 | 1 |
| | 630A | | | | | | |

* MRP - Maximum Retail Price Inclusive of all taxes including GST.
 ■ Price available on request.

Bold Cat.Nos are products normally available with Legrand (India) Stockists. Cat.Nos that are not bold - delivery within 4 - 8 weeks from the date of order. Bold packing quantity is our mandatory packing. Orders to be placed by Legrand (India) Stockist in multiples of the same.

Accessories



0271 80

| Type | Rated Current (A) | Padlocks | | |
|-----------|-------------------|-------------|------|------|
| | | 3P One Side | | |
| | | Cat.No | MRP | Pack |
| DRX 125HP | 125A | 0271 80 | 2080 | 1 |
| DRX 250HP | 250A | | | |
| DRX 630 | 400A | 0262 40 | 3130 | 1 |
| | 630A | | | |

Key Locks

| Type | | Cat.No | MRP | Pack |
|---------------------------------------|--------|---------|------|------|
| For DRX 125HP/250HP for Direct Handle | Random | 6687 74 | 3220 | 1 |
| | A | 6687 75 | 3220 | 1 |
| | B | 6687 76 | 3220 | 1 |

Key Locks

| Type | | Cat.No | MRP | Pack |
|---|--------|---------|------|------|
| For DRX 125HP/250HP for Vary Depth Handle | Random | 6687 77 | 3170 | 1 |
| | A | 6687 78 | 3170 | 1 |
| | B | 6687 79 | 3170 | 1 |

Key Locks

| Type | | Cat.No | MRP | Pack |
|-----------------------------------|--------|---------|------|------|
| For DRX 630 for Vary Depth Handle | Random | 6687 82 | 3170 | 1 |
| | A | 6687 83 | 3170 | 1 |
| | B | 6687 84 | 3170 | 1 |

Auxiliary Contact

| | Cat.No | MRP | Pack |
|------------------------|---------|------|------|
| DRX 125HP DRX 250HP | 0271 40 | 1330 | 1 |
| DRX 630 | 4210 11 | ■ | 1 |

Trip Alarm Contact

| | | | |
|------------------------|---------|------|---|
| DRX 125HP DRX 250HP | 0271 41 | 1330 | 1 |
| DRX 630 | 4210 11 | ■ | 1 |

Trip Alarm Contact

| | | | |
|------------------------|---------|------|---|
| DRX 125HP DRX 250HP | 0271 42 | 2320 | 1 |
|------------------------|---------|------|---|

* MRP - Maximum Retail Price Inclusive of all taxes including GST.
■ Price available on request.

DRX™ MCCB

| Type and frame size | Rated Current (A) | Poles | Cat.Nos | MRP* ₹ / Unit | Pack |
|---------------------|-------------------|-------|---------|---------------|------|
|---------------------|-------------------|-------|---------|---------------|------|

DRX MCCBs

| | | | | | |
|------------------------|-------|--------|---------|------|------|
| DRX 100 Icu = 10 kA | 63 A | 3 Pole | 0270 39 | 4450 | 1/12 |
| | 75 A | 3 Pole | 0270 07 | 4450 | 1/12 |
| | 100 A | 3 Pole | 0270 08 | 4450 | 1/12 |
| | 125 A | 3 Pole | 0270 09 | 5840 | 1/12 |
| | 63 A | 4 Pole | 0270 29 | 6410 | 1/12 |
| | 75 A | 4 Pole | 0270 17 | 6410 | 1/12 |
| | 100 A | 4 Pole | 0270 18 | 6410 | 1/12 |
| | 125 A | 4 Pole | 0270 19 | 6890 | 1/12 |



0270 08

| Description | Cat.Nos | MRP* ₹ / Unit | Pack |
|-------------|---------|---------------|------|
|-------------|---------|---------------|------|

Din Rail Adaptor

| | | | |
|---------|---------|-----|---|
| DRX 100 | 0271 87 | 610 | 1 |
|---------|---------|-----|---|

Rotary Handles - Direct

| | | | |
|---------|---------|------|---|
| DRX 100 | 6687 70 | 1530 | 1 |
|---------|---------|------|---|

Rotary Handles - Vary-Depth

| | | | |
|---------|---------|------|---|
| DRX 100 | 6687 71 | 2330 | 1 |
|---------|---------|------|---|

Padlocking Support For Operating Handle

| | | | |
|---------|---------|------|---|
| DRX 100 | 0271 80 | 2080 | 1 |
|---------|---------|------|---|

Connection Accessories

| | | | |
|-----------------------------|---------|-----|---|
| Set of 2 shields for 3 pole | 0271 81 | 150 | 1 |
|-----------------------------|---------|-----|---|

Sealable Terminal Shields (Moulded Shrouds)

| | | | |
|----------------------|---------|------|---|
| For DRX 100 - 3 pole | 0271 83 | 1990 | 1 |
| For DRX 100 - 4 pole | 0271 84 | 1860 | 1 |



0271 83

Cage Terminals

| | | | |
|----------------------|---------|-----|---|
| For DRX 100 - 3 pole | 0271 71 | 400 | 1 |
| For DRX 100 - 4 pole | 0271 73 | 380 | 1 |

Electrical Accessories

| | | | |
|---|---------|------|---|
| Block with 1 auxiliary (1 AUX) | 0271 40 | 1330 | 1 |
| Block with 1 alarm (1 AL) | 0271 41 | 1330 | 1 |
| Block with 1 auxiliary + 1 alarm (1 AUX + 1 AL) | 0271 42 | 2320 | 1 |



0271 40

Current Shunt Coils

| | | | |
|------------------|---------|------|---|
| 200/277 V~ and = | 0271 54 | 2880 | 1 |
| 380/480 V~ and = | 0271 55 | 2880 | 1 |

Undervoltage Release Coils

| | | | |
|------------|---------|------|---|
| 200/240 V~ | 0271 64 | 3990 | 1 |
| 380/415 V~ | 0271 65 | 3990 | 1 |

DRX Spreader Links

| | | | |
|--------------------|---------|-----|---|
| 3 Links set for TP | 6250 10 | 330 | 1 |
| 4 Links set for FP | 6250 11 | 480 | 1 |

Metal One Way Enclosures For MCCB

| Cat.Nos | Description | No. of modules | MRP* ₹ / Unit | Pack |
|---------|---------------------------|----------------|---------------|------|
| 5078 05 | DRX 100 MCCB enclosure-TP | 3 | ■ | 1 |
| 5078 06 | DRX 100 MCCB enclosure-FP | 3 | 3176 | 1 |

* MRP - Maximum Retail Price Inclusive of all taxes including GST.
Bold Cat.Nos are products normally available with Legrand (India) Stockists.
Cat.Nos that are not bold - delivery within 4 - 8 weeks from the date of order.
Bold packing quantity is our mandatory packing. Orders to be placed by Legrand (India) Stockist in multiples of the same.



0271 40

CAST RESIN

Transformers

High-Efficiency Power Distribution for Critical Installations



Green T.HE cast resin transformers are designed for efficient and reliable power distribution in indoor environments such as data centres, commercial buildings, and critical infrastructure. Engineered to reduce electrical losses and improve operational performance, they support energy-efficient installations while helping lower CO₂ emissions.

Features

- Power ratings from 100 kVA to 3150 kVA
- 10% reduced No load losses
- Copper or aluminium windings for flexible performance and cost optimisation
- Designed in compliance with IEC 60076-11 & EN 50708
- E2-C2-F1 Certified

Benefits

- High reliability for critical power distribution applications
- Reduced energy losses and operating costs
- Lower maintenance with dry-type transformer construction
- Environmentally responsible solution with reduced lifecycle impact

Scan to know more about the product.



XL³ DO

Smart Switchboard complying IEC61439 1&2



MECHANICAL STRENGTH
• 5-Fold Uprights
• 2mm Load Bearing Member



DMC Busbar Support
to handle 960° C



EXTENDABLE PANEL DESIGN
• Complete Bolted design



Design Ambient
• Designed for 50°C to withstand the harsh Indian conditions



3-WAY CORNER BLOCK
• Zero welding corners
• Higher Life



Special Hinge design
• Spacious compartment
• Easy maintenance



**IP54 /
IP43**



Mechanical Impact
• Tested for 1K10



APPLICATION



Commercial Building



Airports



Data Center



Hospital



Marine & MES



Chemical Industry

LBPLUS DATA

High-Efficiency Lighting and Power Distribution



The LB PLUS range is a modular busbar system engineered for high-performance energy distribution in commercial and industrial ceilings. Designed as a plug-and-play alternative to traditional cable trays, it enables scalable power distribution for standard LED lighting as well as advanced smart lighting management.

Features

- Dual-profile design for standard and long-span installations
- IP55 and IK07 protection for demanding environments
- DATA version supporting DALI and 1–10V lighting control
- Rapid-connect tap-off plugs in 10A, 16A, and 25A options

Benefits

- Enables flexible power distribution with quick addition or relocation of power points
- Reduces installation time with modular plug-and-play assembly
- Supports energy-efficient lighting through intelligent control systems
- Ensures dependable performance with certified safety and compliance standards

Scan to know more about
the product.

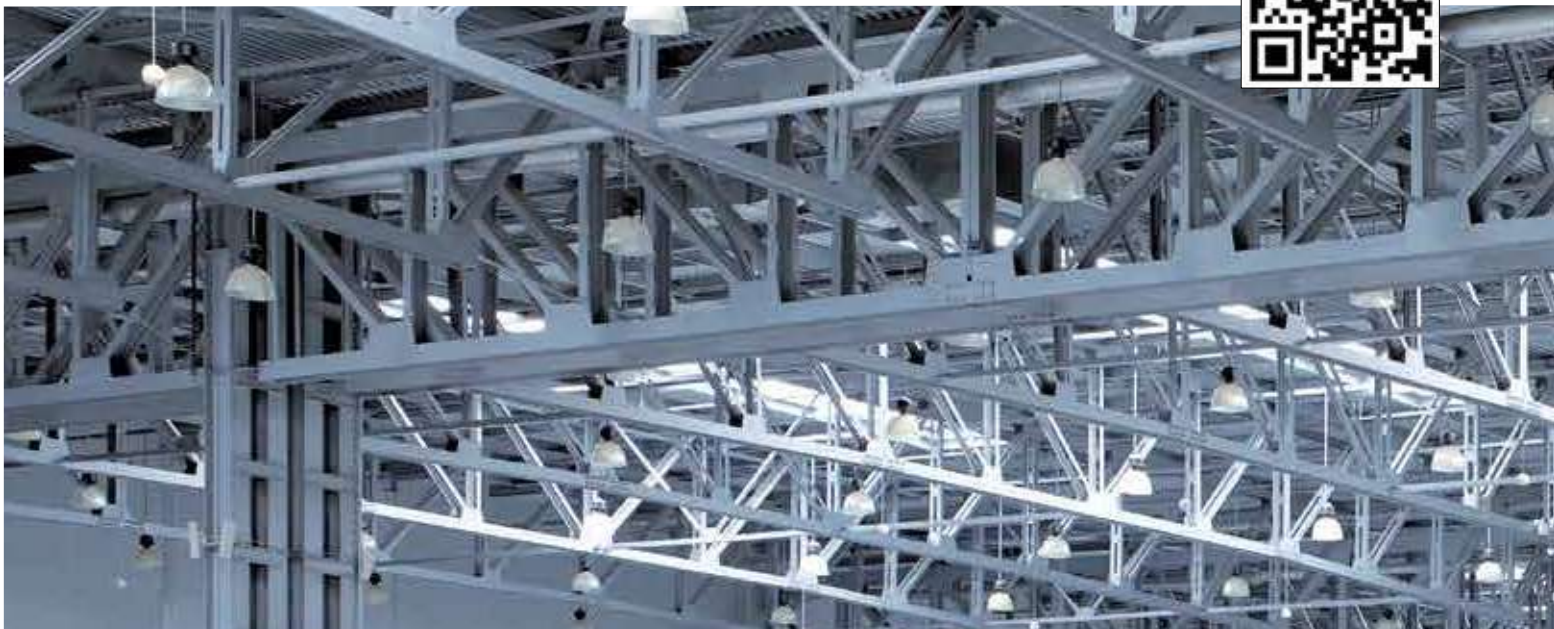

RCP IP68

Resin Cast Busbar



Reliable High-Power Energy Distribution

The RCP IP68 Resin Busbar Trunking System is engineered for high-power distribution in demanding industrial environments. Its sealed construction ensures reliable operation in areas exposed to moisture, corrosion, or temporary immersion while complying with IEC 61439-6 Busbar Trunking Systems standards.

Features

- IP68 protection against dust and water immersion
- Current ratings from 630 A to 6300 A for high-power distribution
- Fully encapsulated with Epoxy Resin
- Conductors insulated in polyester film
- Maintenance Free
- Mechanical Impact : IK10

Benefits

- Ensures reliable power distribution in harsh corrosive environments
- Reduced maintenance due to sealed, durable design
- Optimized for continuous high-current power distribution
- Long service life with robust insulation and mechanical strength

Scan to know more about the product.



DSX

Switch Disconnecter & Changeovers

Safety, Strength & Easy DIN-Rail Installation



DSX DIN Frame 2 is a range of switch disconnectors and transfer switches designed for modern power switching applications. With visible contact separation, pop-up ON/OFF indication, and robust AC23A performance, it ensures safe isolation and dependable operation.

Features

- Visible contact separation with pop-up status indication
- Compact DIN-rail or plate mounting design with ratings up to 320 A
- AC23A rated switching performance
- IEC 60947-3 compliant with accessory compatibility

Benefits

- Enhances operator safety with clear switching visibility
- Saves panel space with a compact installation footprint
- Ensures reliable switching for demanding load conditions
- Enables flexible installation with Legrand's MCCB and MCB systems



Range



SD DIN LINE



TSE DIN LINE



SD POWER LINE



TSE POWER LINE

Scan to know more about
the product.



DSX

NEW RANGE FOR POWER SWITCHING NEEDS OF MODERN INSTALLATIONS

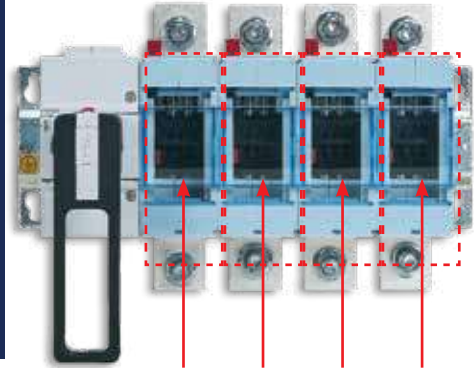

The physical separation of the main contacts is visible through a transparent cover.



Pop up indicators

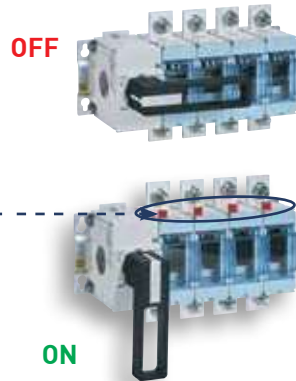

Innovative Design



Safe



Ease of Installation



Robust

DSX SD/TSE

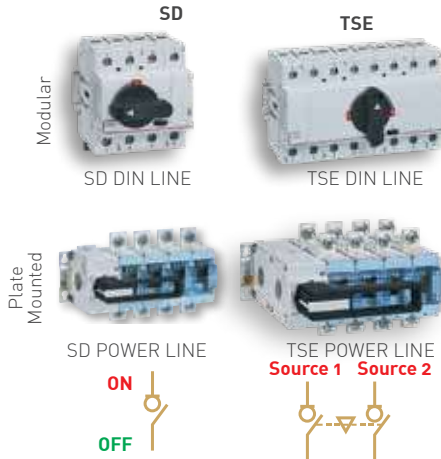

| Frame --> | DIN LINE 1 | DIN LINE 2 | POWER LINE 1 | POWER LINE 2 |
|-------------------------------|--------------------|--------------------|-----------------------|--------------------|
| Ratings | 32A, 40A, 63A | 100A, 125A, 160A | 63A, 100A, 125A, 160A | 200A, 250A, 320A |
| Rated Operational Voltage, Ue | 690V AC 250V DC | 500V AC 250V DC | 690V AC 250V DC | 690V AC 250V DC |
| Rated Insulation Voltage, Ui | 690V AC | 690V AC | 1000V AC | |
| Rated Impulse Voltage, Uimp | 8KV | 8KV | 8KV | 12KV |
| Mechanical Life | 10000 | 7000 | 10000 | 10000 |
| Electrical Life | 2000 | 1000 | 2500 | 2000 |
| Icw for 1 Sec | 1.5KA | 2.5KA | 8KA | 12.5KA |

@12000 for DIN LINE 1 SD/ 10000 for DIN LINE 1 TSE

| Type | Rated Current (A) | Switch Disconnecter | | | TSE (Changeover Switch) | | | TSE (Changeover Switch) with Enclosure | | |
|---------------------------|-------------------|---------------------|-------------|------|-------------------------|-------------|------|--|-------------|------|
| | | Cat.Nos | MRP*/₹/Unit | Pack | Cat.Nos | MRP*/₹/Unit | Pack | Cat.Nos | MRP*/₹/Unit | Pack |
| DIN Line Frame 1 (3P + N) | 32A | 4240 06 | 4040 | 1 | 4241 06 | 7220 | 1 | | | |
| | 40A | 4240 07 | 4240 | 1 | 4241 07 | 7540 | 1 | | | |
| | 63A | 4240 08 | 5040 | 1 | 4241 08 | 8800 | 1 | | | |
| DIN Line Frame 2 (3P) | 100A | 4240 03 | 8260 | 1 | 4241 03 | ■ | 1 | | | |
| | 125A | 4240 04 | 8500 | 1 | 4241 04 | ■ | 1 | | | |
| | 160A | 4240 05 | 10620 | 1 | 4241 05 | ■ | 1 | | | |
| DIN Line Frame 2 (4P) | 100A | 4240 09 | 8730 | 1 | 4241 09 | 17700 | 1 | | | |
| | 125A | 4240 46 | 9090 | 1 | 4241 46 | 18880 | 1 | | | |
| | 160A | 4240 47 | 14750 | 1 | 4241 47 | 25960 | 1 | | | |
| POWER Line Frame 1 (4P) | 63A | 4240 82 | 6020 | 1 | 4241 82 | 10600 | 1 | 424192 | 15790 | 1 |
| | 100A | 4240 83 | 11120 | 1 | 4241 83 | 13310 | 1 | 424193 | 19200 | 1 |
| | 125A | 4240 84 | 13640 | 1 | 4241 84 | 18150 | 1 | 424194 | 22040 | 1 |
| | 160A | 4240 85 | 18410 | 1 | 4241 85 | 20660 | 1 | 424195 | 28400 | 1 |
| POWER Line Frame 2 (4P) | 200A | 4240 86 | 20000 | 1 | 4241 86 | 27620 | 1 | 424196 | 33890 | 1 |
| | 250A | 4240 87 | 23380 | 1 | 4241 87 | 38140 | 1 | 424197 | 45680 | 1 |
| | 320A | 4240 88 | 25820 | 1 | 4241 88 | 39070 | 1 | 424198 | 47870 | 1 |

Accessories

| | DIN LINE 1 | | |
|--|------------|-------------|------|
| | Cat.Nos | MRP*/₹/Unit | Pack |
| Shorting Links for TSE (set of 4) | 4242 01 | 1120 | 1 |
| Terminal Shield IP20 - 3P# | 4242 02 | 460 | 1 |
| Terminal Shield IP20 - 1P# | 4242 03 | 370 | 1 |
| Auxiliary contact (1 NO + 1 NC) | 4242 08 | 590 | 1 |
| Vary Depth Handle | 4242 09 | 1650 | 1 |
| | DIN LINE 2 | | |
| | Cat.Nos | MRP*/₹/Unit | Pack |
| DSX Shorting links ECO Frame 2 (160A) 4P - DIN | 4242 12 | 2360 | 1 |
| DSX DIN Shorting links 160A 3P | 4242 11 | 2120 | 1 |

| | POWER LINE 1 | | | POWER LINE 2 | | |
|--|--------------|-------------|------|--------------|-------------|------|
| | Cat.Nos | MRP*/₹/Unit | Pack | Cat.Nos | MRP*/₹/Unit | Pack |
| Auxiliary contact 4 NO + 4NC | 4242 45 | 1650 | 1 | 4242 45 | 1650 | 1 |
| Aux Contact (1NO+1NC) Early Make/Break | 4242 44 | 1950 | 1 | 4242 44 | 1950 | 1 |
| Spreaders Terminals (One Side i.e. Set of 4) | 4242 54 | 1300 | 1 | 4242 38 | 2580 | 1 |
| Terminal Shield IP20 - 4P | 4242 47 | 1320 | 1 | 4242 36 | 1520 | 1 |
| Phase Barriers | 4242 51 | 260 | 1 | 4242 43 | 330 | 1 |
| Inter Source Barrier | 4242 52 | 330 | 1 | 4242 39 | 530 | 1 |
| Shorting Links for TSE (Set of 4) | 4242 49 | 3170 | 1 | 4242 41 | 4770 | 1 |
| Direct Handle | 4242 30 | 1390 | 1 | 4242 30 | 1390 | 1 |
| Vary Depth Handle | 4242 31 | 1980 | 1 | 4242 31 | 1980 | 1 |
| Direct Key Lock | 4242 34 | 1390 | 1 | 4242 34 | 1390 | 1 |

To be Ordered together as 1 set for 4P SD and 2 sets for 4P TSE.

SD POWER LINE --> Packaging Includes SD, Phase Barriers, Vary Depth Handle.

TSE POWER LINE --> Packaging Includes TSE, Phase Barriers, Inter Source Barrier, Vary Depth Handle, Shorting Links.

■ Price available on request.

EMDX³

Smart Electricity Meters

Sustainable Energy Savings for your Installations



The EMDX³ range of smart multifunction meters enables precise energy monitoring for single-phase and three-phase electrical networks. Designed for commercial and industrial applications, the meters support direct or CT connections and integrate with supervision systems

Features

- Single-phase, three-phase, and CT-based metering options
- MID-certified models with bi-directional energy measurement
- Advanced electrical and power quality monitoring
- Modbus RS-485 and pulse output connectivity

Benefits

- Improves energy efficiency through accurate consumption monitoring
- Supports sustainable energy management and reporting
- Enables reliable sub-metering for billing and cost allocation
- Enhances network reliability with continuous power quality monitoring



A meter should be selected according to the network (single-phase or three-phase) and its maximum current, required displayed values and communication type allowing it to be run by a supervision system.



Conforming to standards IEC 61557-12, IEC 62053-21/23, IEC 62052-11, IEC 62052-31, EN 50470-1/3 [for the MID version]

Scan to know more about the product.



EMDX³
Multi-Function Meters for Smart Distribution Board

Din Rail Mounting

Din Rail Meters for Smart Distribution Board. LCD meter with bright graphical back lit display. 1P / 3P Direct connection or connection with CT. Measures kWh as well as other values like current, voltage, active energy, power etc.

Confirms to Standards: IEC 61557-12; IEC 62053-21/23; IEC 62052-11 and IEC 62052-31

MID* compliance ensures accuracy for billing

Dual Tariff meters

WAGES Enabled (1 Pulse input to connect water meter, gas meter etc.)

*MID - Measuring Instruments Directive. The meters comply to MID, ensures the highest levels of reliability and transparency, and in order to provide complete metrological assurance, applications that necessitate the installation of meters dedicated to invoicing purposes.

Direct Connection

Single Phase

| Cat. Nos | Current Rating (A) | Description | No. of Modules | MRP* ₹ / Unit | Pack |
|----------|--------------------|---|----------------|---------------|------|
| 0046 70 | 32 | 32A 1P Energy Meter with Pulse Output | 1 | ■ | 1 |
| 4120 68 | 45 | 45A 1P Multi Function Meter with RS-485 | 1 | ■ | 1 |
| 4120 69 | 45 | 45A 1P Multi Function Meter with Pulse Output - MID | 1 | ■ | 1 |
| 4120 80 | 63 | 63A 1P Multi Function Meter with WAGES & Pulse Output | 2 | ■ | 1 |
| 4120 82 | 63 | 63A 1P Multi Function Meter with WAGES & Pulse Output - MID | 2 | ■ | 1 |
| 4120 81 | 63 | 63A 1P Multi Function Meter with Dual Tariff / WAGES & RS-485 | 2 | ■ | 1 |
| 4120 83 | 63 | 63A 1P Multi Function Meter with Dual Tariff / WAGES & RS-485 - MID | 2 | ■ | 1 |

* MRP - Maximum Retail Price Inclusive of all taxes including GST.
 ■ Price available on request.



4120 80



4120 91

EMDX³
Multi-Function Meters for Smart Distribution Board

| Cat. Nos | Current Rating (A) | Description | No. of Modules | MRP* ₹ / Unit | Pack |
|----------|--------------------|-------------|----------------|---------------|------|
|----------|--------------------|-------------|----------------|---------------|------|

Direct Connection

Three Phase

| | | | | | |
|---------|-----|--|---|---|---|
| 4120 90 | 63 | 63A 3P Multi Function Meter with WAGES & Pulse Output | 4 | ■ | 1 |
| 4120 92 | 63 | 63A 3P Multi Function Meter with WAGES & Pulse Output - MID | 4 | ■ | 1 |
| 4120 91 | 63 | 63A 3P Multi Function Meter with Dual Tariff / WAGES & RS-485 | 4 | ■ | 1 |
| 4120 93 | 63 | 63A 3P Multi Function Meter with Dual Tariff / WAGES & RS-485 - MID | 4 | ■ | 1 |
| 4120 74 | 125 | 125A 3P Multi Function Meter with Dual Tariff / WAGES, RS-485 & Pulse Output | 6 | ■ | 1 |
| 4120 75 | 125 | 125A 3P Multi Function Meter with Dual Tariff / WAGES, RS-485 & Pulse Output - MID | 6 | ■ | 1 |

Connection with CT

| | | | | | |
|---------|---|---|---|---|---|
| 4120 40 | 5 | 3P with CT Multi Function Meter with WAGES & Pulse Output | 4 | ■ | 1 |
| 4120 42 | 5 | 3P with CT Multi Function Meter with WAGES & Pulse Output - MID | 4 | ■ | 1 |
| 4120 41 | 5 | 3P with CT Multi Function Meter with Dual Tariff / WAGES & RS-485 | 4 | ■ | 1 |
| 4120 43 | 5 | 3P with CT Multi Function Meter with Dual Tariff / WAGES & RS-485 - MID | 4 | ■ | 1 |

Bold Cat.Nos are products normally available with Legrand (India) Stockists. Cat.Nos that are not bold - delivery within 4 - 8 weeks from the date of order. Bold packing quantity is our mandatory packing. Orders to be placed by Legrand (India) Stockist in multiples of the same.

EMDX³ Digital Panel Meter

| Cat. Nos | Description | MRP* ₹ / Unit | Pack |
|----------|-------------|------------------|------|
|----------|-------------|------------------|------|

Modular Multi Function Meter

LCD meter with bright graphical back lit display.

4 Dedicated Keys (V / I / P Q S / E P F F)

Precision class 1 / 0.5

Connection with current transformers (CT)

Measurement of currents, voltages, frequency, active, reactive and apparent power, power factor, active and reactive energy

4 tariff metering

THD voltages, currents and harmonic analysis up to order 25th (available on Modbus COM port)

Programmable alarms on all functions

RS 485 and pulse output

Phase sequence correction diagnostic

Customized display page

| Cat. Nos | Current Rating (A) | Description | No. of Modules | MRP* ₹ / Unit | Pack |
|----------|--------------------|-------------|----------------|------------------|------|
|----------|--------------------|-------------|----------------|------------------|------|

| | | | | | |
|---------|---|--|---|---|---|
| 4120 45 | 5 | Modular Multi Function Meter with THD - RS-485 & Pulse Output CI 1 | 4 | ■ | 1 |
|---------|---|--|---|---|---|

| | | | | | |
|---------|---|---|---|---|---|
| 4120 51 | 5 | 4 Tariff Modular Multi Function Meter with Individual THD, Programmable alarms - RS-485 & Pulse Output CI 0.5 | 4 | ■ | 1 |
|---------|---|---|---|---|---|



4120 51

Pulse Concentrator

For collecting and transmitting measurements taken by 12 universal pulse electricity meters.

Collects pulses from other meters (gas meters, water meters, etc.) RS-485 output

| Cat. Nos | Description | No. of Modules | MRP* ₹ / Unit | Pack |
|----------|-------------|----------------|------------------|------|
|----------|-------------|----------------|------------------|------|

| | | | | |
|---------|--------------------|---|---|---|
| 4120 65 | Pulse Concentrator | 4 | ■ | 1 |
|---------|--------------------|---|---|---|



4120 65

* MRP - Maximum Retail Price Inclusive of all taxes including GST.
■ Price available on request.

EMDX³ Digital Panel Meter

| Cat. Nos | Description | MRP* ₹ / Unit | Pack |
|----------|-------------|------------------|------|
|----------|-------------|------------------|------|

Communication Interface

For mounting on door or solid faceplate

Dimensions: 96 x 96 x 62 mm

LCD meter with bright graphical back lit display.

4 Dedicated Keys (V / I / P Q S / E P F F)

Measurement of currents, voltages, active, reactive and apparent power and power factor

Metering:

- Active energy consumed or produced
- Reactive energy consumed or produced
- Operating time
- Pulses
- THD voltages, currents, and individual harmonic up to order 25(1)
- RS 485 communication and Pulse output
- Phase sequence correction diagnostic
- Optorelays with potential-free SPST-NO contact
- Customized display page

| Cat. Nos | Description | MRP* ₹ / Unit | Pack |
|----------|-------------|------------------|------|
|----------|-------------|------------------|------|

| | | | |
|---------|--|---|---|
| 4120 47 | Multi Function Meter with THD - RS-485 & Pulse Output CI 1 | ■ | 1 |
|---------|--|---|---|

| | | | |
|---------|---|---|---|
| 4120 52 | Advance Multi Function Meter with Individual THD - RS-485 & Pulse Output CI 0.5 | ■ | 1 |
|---------|---|---|---|



4120 52

Power Quality & Network Analyzer with Data Logger

Dimensions: 96 x 96 x 62 mm

LCD meter with bright graphical back lit display.

Customized display page

4 Dedicated Keys (V / I / P Q S / E P F F)

Precision class: 0.5

Measurement of currents, voltages, active, reactive

Bold Cat.Nos are products normally available with Legrand (India) Stockists. Cat.Nos that are not bold - delivery within 4 - 8 weeks from the date of order. Bold packing quantity is our mandatory packing. Orders to be placed by Legrand (India) Stockist in multiples of the same.

EMDX³
Power Quality & Network Analyzer with Data Logger

| Cat. Nos | Description | MRP* ₹ / Unit | Pack |
|----------|-------------|------------------|------|
|----------|-------------|------------------|------|

and apparent power, internal temperature and power factor

Metering:

- active energy consumed or produced
- Reactive energy consumed or produced
- Operating time
- THD
- Programmable alarms on all functions
- Power quality functions: harmonics (U & I) to 50th, dips, swells, interruption, rapid voltage change and flickers
- Memory embedded (8 Mb)
- RTC (real time clock)
- Can take 4 EMDX3 optional modules

| Cat. Nos | Description | MRP* ₹ / Unit | Pack |
|----------|-------------|------------------|------|
|----------|-------------|------------------|------|

| | | | |
|---------|---|---|---|
| 4120 53 | Power Quality & Network Analyzer with Data Logger | ■ | 1 |
| 4120 55 | R485 communication module with Modbus link | ■ | 1 |
| 4120 59 | 2 Pulse output module for energy count | ■ | 1 |
| 4120 57 | 2 inputs / 2 outputs module | ■ | 1 |
| 4120 60 | 2 analog outputs module | ■ | 1 |
| 4120 58 | Temperature module | ■ | 1 |

* MRP - Maximum Retail Price Inclusive of all taxes including GST.
 ■ Price available on request.



0046 89

EMDX³
Energy Management Multi-Support Web Servers

| Cat. Nos | Description | MRP* ₹ / Unit | Pack |
|----------|-------------|------------------|------|
|----------|-------------|------------------|------|

RS485 / Ethernet

| | | | |
|---------|---|---|---|
| 0046 89 | IP converter For RS 485/Ethernet conversion for connecting electricity meters and measurement control units to an IP network | ■ | 1 |
|---------|---|---|---|

Energy Management Multi-Support Web Servers

Allow remote configuration, test, control and visualization, via a web browser on PCs, smartphones, web viewers, tablet computers, of data

Features

- In-built IP converter
- Power supply: 9 to 28 V= with the help of a single-phase switching mode power supply Cat.No 1 467 21 to be ordered separately
- With the Legrand Power supervision system, circuit breakers are integrated in a supervision system
- You can therefore check the status of the circuit breakers, measure the electrical values and control the circuit breakers remotely
- MODBUS protocol

| Cat. Nos | Description | MRP* ₹ / Unit | Pack |
|----------|-------------|------------------|------|
|----------|-------------|------------------|------|

| | | | |
|---------|--|---|---|
| 4149 47 | For 10 Modbus addresses or 10 pulse modules | ■ | 1 |
| 4149 48 | For 32 Modbus addresses or 32 pulse modules | ■ | 1 |
| 4149 49 | For 255 Modbus addresses or 255 pulse modules Supplied with external power supply and fixing" brackets | ■ | 1 |



4149 48

Bold Cat.Nos are products normally available with Legrand (India) Stockists. Cat.Nos that are not bold - delivery within 4 - 8 weeks from the date of order. Bold packing quantity is our mandatory packing. Orders to be placed by Legrand (India) Stockist in multiples of the same.

PMX

DIGITAL PANEL METERS

Precise Monitoring for Smarter Energy Management



The PMX series of digital panel meters provides a comprehensive metering solution for low-voltage installations, ranging from basic volt and amp meters to advanced multifunction meters and power quality analyzers. These meters help monitor, analyse, and optimise electrical loads across panels, generators, and industrial equipment.

Features

- Wide range from basic meters to advanced multifunction models
- True RMS measurements with high accuracy
- Universal power supply with flexible CT/PT configurations
- Communication-ready with Modbus and pulse outputs

Benefits

- Improves visibility of electrical parameters for better load management
- Enables accurate energy monitoring and cost allocation
- Enhances reliability through power quality and demand tracking
- Simplifies panel design by replacing multiple analog meters with a compact digital solution



Scan to know more about the product.



PMX Digital Panel Meters

| Cat.Nos | Model Series | Description | MRP* ₹ / Unit | Pack |
|---------|--------------|-------------|------------------|------|
|---------|--------------|-------------|------------------|------|

PMX 1000 Precise Single Function Meters

Features

- **RoHS Compliance**
- True RMS measurement
- High accuracy with class 1 as per IEC 62053-21
- Volts & Amps: $\pm 1.0\%$ of Rated Current.
- **Bright 7 Segment LED display with four digit resolution and 14mm Height**
- Auto and Manual scrolling
- **Site selectable CT/PT ratios**
- Site selectable CT Secondary 1 A/5 A
- **Site selectable 3Phase 4Wire, 3Phase 3Wire & 1Ph configuration**
- Suitable for 50/60 Hz
- Wide range of control power supply 80 - 300 V AC, 40-70 Hz
- Low burden < 0.2 VA per phase Volts & Amps
- Average & Phase wise measurements
- Password protection



4149 77



4149 78

| | | | | |
|---------|----------|-------------------------|------|---|
| 4149 75 | PMX 1100 | 1Ph Ammeter CI 1 | 1652 | 1 |
| 4149 76 | PMX 1200 | 1Ph Voltmeter CI 1 | 1652 | 1 |
| 4149 77 | PMX 1103 | 3 Ph Ammeter CI 1 | 2392 | 1 |
| 4149 78 | PMX 1203 | 3Ph Voltmeter CI 1 + Hz | 2392 | 1 |

PMX 4000 True VAF + PF Meter

Features

- **RoHS Compliance**
- **Displays Current, line to neutral & line to line Voltages, frequency & Power Factor. (VA & PF - Phase Wise & Average)**
- **Display on Hours**
- True RMS measurement with simulations sampling of Current & Voltage
- High accuracy with class 1 as per IEC 62053-21 Volts & Amps: $\pm 1.0\%$ of Rated Current.
- **3 Row Display with LED status for different parameter selection.**
- Auto and Manual scrolling
- Site selectable CT/PT ratios
- Site selectable CT Secondary 1 A/5 A
- Site selectable 3Phase 4Wire, 3Phase 3Wire & 1Ph configuration
- Suitable for 50/60 Hz
- Universal control power supply 80 - 300 V AC/DC, 40-70 Hz
- Low burden < 0.2 VA per phase Volts & Amps
- Average & Phase wise measurements
- **Password protection**
- **Seamless integration with EMS/SCADA system with RS485 serial channel communication,**



4149 82

PMX Digital Panel Meters

| Cat.Nos | Model Series | Description | MRP* ₹ / Unit | Pack |
|---------|--------------|-------------|------------------|------|
|---------|--------------|-------------|------------------|------|

Industry standard Modbus RTU protocol.

| | | | | |
|---------|----------|-------------------------------------|------|---|
| 4149 79 | PMX 4000 | 3 Ph VAF + PF meter CI 1 | 4050 | 1 |
| 4149 80 | PMX 4000 | 3 Ph VAF + PF meter CI 1 with RS485 | 4830 | 1 |



4149 80

PMX 5000 Smart Energy Meters For Smart Energy Billing

Features

- **RoHS Compliance**
- kWh/kVA
- **Old Energy register for back up of last cleared energy values**
- Bright LED with parameter name and value
- Auto scaling capability in adjustment of Kilo, Mega, Giga.
- kWh / kVA / PF / W - any one programmable
- **Positive energy accumulation even with CT polarity reversal with reverse lock program**
- High Accuracy with class 1 as per IEC 62053-21
- Site selectable CT/PT ratios
- Site selectable CT Secondary 1 A/5 A
- Universal control power supply 80 - 300 V AC/DC, 40-70 Hz
- Password protection for tamper proofing
- **Seamless integration with EMS/SCADA system with RS485 serial channel communication, Industry standard Modbus RTU protocol.**
- **Pulse output for integration into a process through PLC/DCS for online energy management**
- Provision for Tamper proofing with meter casing* *optional strip for tamper proofing.

| | | | | |
|---------|----------|--------------------------------------|------|---|
| 4149 81 | PMX 5000 | kWh LED meter CI 1 | 4642 | 1 |
| 4149 82 | PMX 5000 | kWh LED meter CI 1 with RS485 | 5332 | 1 |
| 4149 83 | PMX 5000 | kWh LED meter CI 1 with Pulse Output | 6480 | 1 |

PMX 6000 Multi Dual Source Meter

Features

- **RoHS Compliance**
- **Bright LED display for showing parameters for both EB & DG**
- **Displays full range of parameters**
Basic : VLL, VLN, A (Avg. & Phase wise), F
Power: W, PF (Avg. & Phase wise)
Energy: Wh
- **Load Hours, Run Hours, Old Wh, Old Load Hours for both EB & DG.**
- **DG Sensing input - 230 VAC**
- Auto scaling capability in adjustment of Kilo, Mega, Giga.
- Positive energy accumulation even with CT polarity reversal with reverse lock program.
- High Accuracy with class 1 as per IEC 62053-21 & class 0.5 as per IEC 62053-22

Bold Cat.Nos are products normally available with Legrand (India) Stockists. Cat.Nos that are not bold - delivery within 4 - 8 weeks from the date of order. Bold packing quantity is our mandatory packing. Orders to be placed by Legrand (India) Stockist in multiples of the same.

* MRP - Maximum Retail Price Inclusive of all taxes including GST.

PMX Digital Panel Meters

| Cat.Nos | Model Series | Description | MRP* ₹ / Unit | Pack |
|---------|--------------|-------------|------------------|------|
|---------|--------------|-------------|------------------|------|

- Site selectable CT/PT ratios
- Site selectable CT Secondary 1 A/5 A
- Universal control power supply 80 – 300 V AC/DC, 40-70 Hz
- Password protection for tamper proofing
- **Seamless integration with EMS/SCADA system with RS485 serial channel communication, Industry standard Modbus RTU protocol.**
- Provision for Tamper proofing with meter casing*
*optional strip for tamper proofing



4149 85

| | | | | |
|---------|----------|---|------|---|
| 4149 84 | PMX 6000 | Dual Source LED meter CI 1 with RS485 | 8280 | 1 |
| 4149 85 | PMX 6000 | Dual Source LED meter CI 0.5 with RS485 | 9860 | 1 |

PMX 7000 Multifunction Meter

Features

- **RoHS Compliance**
- **Bright LED display to view more than 25 parameters.**
- Displays full range of parameters
Basic : VLL, VLN, A (Avg. & Phase Wise), F
Power: W, PF, VA (Avg. & Phase Wise)
Energy: Wh,
- **Load Hours, Run Hours, Old Wh, Old Load Hours**
- Auto scaling capability in adjustment of Kilo, Mega, Giga.
- **Positive energy accumulation even with CT polarity reversal with reverse lock programmable**
- High Accuracy with class 1 as per IEC 62053-21
- Site selectable CT/PT ratios
- Site selectable CT Secondary 1 A/5 A
- Universal control power supply 80 – 300 V AC/DC, 40-70 Hz
- Password protection for tamper proofing
- **Seamless integration with EMS/SCADA system with RS485 serial channel communication, Industry standard Modbus RTU protocol**
- Provision for Tamper proofing with meter casing*
*optional strip for tamper proofing



4149 90



4149 91

| | | | | |
|---------|----------|---|-------|---|
| 4149 90 | PMX 7000 | MFM (VAF + W/VA/PF/Wh) LED meter CI 1 with RS485 [^] | 8230 | 1 |
| 4149 91 | PMX 7300 | MFM LED meter CI 1 | 9950 | 1 |
| 4149 92 | PMX 7300 | MFM LED meter CI 1 with RS485 | 11880 | 1 |

* MRP - Maximum Retail Price Inclusive of all taxes including GST.

PMX Digital Panel Meters

| Cat.Nos | Model Series | Description | MRP* ₹ / Unit | Pack |
|---------|--------------|-------------|------------------|------|
|---------|--------------|-------------|------------------|------|

PMX 7400

Advance Multifunction Meter / Load Manager / Demand Monitor

Features

- **RoHS Compliance**
- **Advance multifunction meter with High/Low recording of VLL, VLN, A, Hz, PF, Var with time stamp.**
- **Voltage & Current THD (Total Harmonics Distortion) with Individual harmonics up to 31st order.**
- **K-factor V & A to keep check on the losses due to harmonic load currents & their effects on transformer heating.**
- Load manager with demand monitoring
- **RTC based Demand management**
- **Import/Export/Net monitoring of Wh, VAh, VARh Inductive/Capacitive, Load hours**
- Auto scaling capability in adjustment of Kilo, Mega, Giga.
- **Positive energy accumulation even with CT polarity reversal with reverse lock programmable**
- High Accuracy with class 1 as per IEC 62053-21 & class 0.5s as per IEC 62053-22
- Site selectable CT/PT ratios
- Site selectable CT Secondary 1 A/5 A
- Universal control power supply 80-300 V AC/DC, 40-70 Hz
- Password protection for tamper proofing
- **Seamless integration with EMS/SCADA system with RS485 serial channel communication, Industry standard Modbus RTU protocol.**
- Byte order option – Field Programmable Float/ Little Endian/ Big Endian data formats

| | | | | |
|---------|----------|--|-------|---|
| 4149 93 | PMX 7400 | MFM + THD LED meter CI 1 with RS485 | 15900 | 1 |
| 4149 94 | PMX 7400 | MFM + THD LED meter CI 0.5 with RS485 | 19500 | 1 |
| 4149 95 | PMX 7410 | MFM + THD + Demand monitoring LED meter CI 1 with RS485 | 23090 | 1 |
| 4149 96 | PMX 7420 | MFM + THD with Individual + Harmonics + Demand + Import/Export LED meter CI 1 with RS485 | 23930 | 1 |



4149 96

Bold Cat.Nos are products normally available with Legrand (India) Stockists. Cat.Nos that are not bold - delivery within 4 - 8 weeks from the date of order. Bold packing quantity is our mandatory packing. Orders to be placed by Legrand (India) Stockist in multiples of the same.

PMX Digital Panel Meters

| Cat.Nos | Model Series | Description | MRP* ₹ / Unit | Pack |
|---------|--------------|---|------------------|------|
| 4149 97 | PMX 7420 | MFM + THD with Individual + Harmonics + Demand + Import/Export LED meter CI 0.5s with RS485 | 27680 | 1 |

PMX 8000 Advance Demand Controller

Features

- RoHS Compliance
- Demand controller with 4 relay output
- High memory Data Logger (8MB) for storing multiple parameters.
- Predictive demand with date & time stamping
- Voltage & Current THD (Total Harmonics Distortion) with Individual harmonics up to 31st order.
- K-factor V & A to keep check on the losses due to harmonic load currents & their effects on transformer heating.
- Advance multifunction meter with High/Low recording of VLL, VLN, A, Hz, PF, Var with time stamp.
- RTC based Demand management
- Import/Export/Net monitoring of Wh, VAH, VARh Inductive/Capacitive, Load hours
- Auto scaling capability in adjustment of Kilo, Mega, Giga.
- Positive energy accumulation even with CT polarity reversal with reverse lock programmable
- High Accuracy with class 1 as per IEC 62053-21
- Site selectable CT/PT ratios
- Site selectable CT Secondary 1 A/5 A
- Universal control power supply 80 - 300 V AC/DC, 40-70 Hz
- Password protection for tamper proofing
- Seamless integration with EMS/SCADA system with RS485 serial channel communication, Industry standard Modbus RTU protocol.
- Byte order option - Field Programmable Float/ Little Endian/ Big Endian data formats



4149 98

| | | | | |
|---------|-------------|--|-------|---|
| 4149 98 | PMX 8000 | Demand Controller CI 1 with data logger + Bi directional + THD with Individual Harmonics | 53650 | 1 |
|---------|-------------|--|-------|---|

* MRP - Maximum Retail Price Inclusive of all taxes including GST.

CTX³ MINI Contactors

Ultra-Compact Contactor
for Motor, Lighting & Heating
Control (Up to 16 A)



CTX³ MINI contactors are compact switching devices designed for reliable control of motors, lighting, and heating circuits up to 16 A. With a space-saving design, flexible mounting options, and integrated auxiliary contacts, they provide an efficient solution for modern distribution boards and control panels where space and reliability are essential.

Features

- Ultra-compact 3-pole design up to 16 A
- DIN-rail or plate mounting options
- IP2X protected screw terminals
- Integrated auxiliary contact for control signalling

Benefits

- Enables space-efficient installation in electrical panels
- Simplifies and speeds up installation and retrofits
- Enhances safety with touch-proof terminal protection
- Ensures reliable switching for motor, lighting, and heating applications



Scan to know more about
the product.

CTX³ RTX³ MPX³

Motor Control Range

Uncompromising Performance for Motor Protection and Control



The CTX³ contactors, RTX³ thermal relays and MPX³ motor protection circuit breakers form a complete and coordinated range for reliable motor protection and control. Designed for commercial and industrial applications, the range combines compact dimensions with robust performance.

Features

- CTX³ contactors and RTX³ thermal relays up to 800 A
- MPX³ motor protection circuit breakers up to 100 A
- High endurance with reliable overload and short-circuit protection
- Compact design with flexible mounting and accessories

Benefits

- Enables simpler motor control architecture with an integrated solution
- Optimises panel layout with reduced wiring complexity
- Enhances system reliability with robust motor protection
- Supports flexible installations across diverse motor applications



Scan to know more about the product.



Mini Contactors CTX³ 6 to 16 A Industrial Contactors

| Cat.Nos | Max. opt. current AC 3 | Max. opt. current AC 1 | Control voltage | MRP* ₹ / Unit | Pack |
|---------|------------------------|------------------------|-----------------|---------------|------|
|---------|------------------------|------------------------|-----------------|---------------|------|

An Ultra Compact Solution Upto 16A (AC3) 3P & 4P

For Switching Motors, Lighting and Heating Circuits
Ultra High Reliability
Ultra High Endurance
Ultra Low Wattloss

Features

Conforms to IEC/EN 60947-4-1
CE & UL Certified
Range From 6A to 16A AC3
Available in 3P & 4P
Click fit accessories
Ultra Compact design
Front and side add on auxiliary contact
Mechanical Interlock unit
mini Thermal Overload Relay

Spare Coils available

RoHS Compliant

3 Pole Mini Contactors

With integrated auxiliary contact
Power terminals: screw terminals



4170 00



4170 01

6 A - Integrated auxiliary contact 1 NO

| | | | | | |
|---------|-----|------|--------|------|---|
| 4170 00 | 6 A | 20 A | 24 V~ | 1810 | 1 |
| 4170 01 | 6 A | 20 A | 24 V= | 2470 | 1 |
| 4170 04 | 6 A | 20 A | 110 V~ | 1810 | 1 |
| 4170 06 | 6 A | 20 A | 230 V~ | 1810 | 1 |
| 4170 09 | 6 A | 20 A | 415 V~ | 1810 | 1 |

6 A - Integrated auxiliary contact 1 NC

| | | | | | |
|---------|-----|------|--------|------|---|
| 4170 10 | 6 A | 20 A | 24 V~ | 1810 | 1 |
| 4170 11 | 6 A | 20 A | 24 V= | 2470 | 1 |
| 4170 14 | 6 A | 20 A | 110 V~ | 1810 | 1 |
| 4170 16 | 6 A | 20 A | 230 V~ | 1810 | 1 |
| 4170 19 | 6 A | 20 A | 415 V~ | 1810 | 1 |

9 A - Integrated auxiliary contact 1 NO

| | | | | | |
|---------|-----|------|--------|------|---|
| 4170 20 | 9 A | 20 A | 24 V~ | 1980 | 1 |
| 4170 21 | 9 A | 20 A | 24 V= | 2630 | 1 |
| 4170 24 | 9 A | 20 A | 110 V~ | 1980 | 1 |
| 4170 26 | 9 A | 20 A | 230 V~ | 1980 | 1 |
| 4170 29 | 9 A | 20 A | 415 V~ | 1980 | 1 |

9 A - Integrated auxiliary contact 1 NC

| | | | | | |
|---------|-----|------|--------|------|---|
| 4170 30 | 9 A | 20 A | 24 V~ | 1980 | 1 |
| 4170 31 | 9 A | 20 A | 24 V= | 2630 | 1 |
| 4170 34 | 9 A | 20 A | 110 V~ | 1980 | 1 |
| 4170 36 | 9 A | 20 A | 230 V~ | 1980 | 1 |
| 4170 39 | 9 A | 20 A | 415 V~ | 1980 | 1 |

12 A - Integrated auxiliary contact 1 NO

| | | | | | |
|---------|------|------|--------|------|---|
| 4170 40 | 12 A | 20 A | 24 V~ | 2150 | 1 |
| 4170 41 | 12 A | 20 A | 24 V= | 3210 | 1 |
| 4170 44 | 12 A | 20 A | 110 V~ | 2150 | 1 |
| 4170 46 | 12 A | 20 A | 230 V~ | 2150 | 1 |
| 4170 49 | 12 A | 20 A | 415 V~ | 2150 | 1 |

12 A - Integrated auxiliary contact 1 NC

| | | | | | |
|---------|------|------|--------|------|---|
| 4170 50 | 12 A | 20 A | 24 V~ | 2150 | 1 |
| 4170 51 | 12 A | 20 A | 24 V= | 3210 | 1 |
| 4170 54 | 12 A | 20 A | 110 V~ | 2150 | 1 |
| 4170 56 | 12 A | 20 A | 230 V~ | 2150 | 1 |
| 4170 59 | 12 A | 20 A | 415 V~ | 2150 | 1 |

* MRP - Maximum Retail Price Inclusive of all taxes including GST.
■ Price available on request.

Mini Contactors CTX³ 6 to 16 A Industrial Contactors

| Cat.Nos | Max. opt. current AC 3 | Max. opt. current AC 1 | Control voltage | MRP* ₹ / Unit | Pack |
|---------|------------------------|------------------------|-----------------|---------------|------|
|---------|------------------------|------------------------|-----------------|---------------|------|

16 A - Integrated auxiliary contact 1 NO

| | | | | | |
|---------|------|------|--------|------|---|
| 4170 60 | 16 A | 20 A | 24 V~ | 2580 | 1 |
| 4170 61 | 16 A | 20 A | 24 V= | 3720 | 1 |
| 4170 64 | 16 A | 20 A | 110 V~ | 2580 | 1 |
| 4170 66 | 16 A | 20 A | 230 V~ | 2580 | 1 |
| 4170 69 | 16 A | 20 A | 415 V~ | 2580 | 1 |

16 A - Integrated auxiliary contact 1 NC

| | | | | | |
|---------|------|------|--------|------|---|
| 4170 70 | 16 A | 20 A | 24 V~ | 2580 | 1 |
| 4170 71 | 16 A | 20 A | 24 V= | 3720 | 1 |
| 4170 74 | 16 A | 20 A | 110 V~ | 2580 | 1 |
| 4170 76 | 16 A | 20 A | 230 V~ | 2580 | 1 |
| 4170 79 | 16 A | 20 A | 415 V~ | 2580 | 1 |

4-Pole Mini Contactors

Without integrated auxiliary contact
Power terminals: screw terminals

| Cat.Nos | Max. opt. current AC 1 | Max. opt. current AC 3 | Control voltage | MRP* ₹ / Unit | Pack |
|---------|------------------------|------------------------|-----------------|---------------|------|
|---------|------------------------|------------------------|-----------------|---------------|------|

20 A

| | | | | | |
|---------|------|------|--------|------|---|
| 4171 40 | 20 A | 16 A | 24 V~ | 2340 | 1 |
| 4171 41 | 20 A | 16 A | 24 V= | 2960 | 1 |
| 4171 44 | 20 A | 16 A | 110 V~ | 2340 | 1 |
| 4171 46 | 20 A | 16 A | 230 V~ | 2340 | 1 |
| 4171 49 | 20 A | 16 A | 415 V~ | 2340 | 1 |

Mini Thermal Overload Relays RTX³ mini

For Mini Contactors

| Cat.Nos | Setting Range | MRP* ₹ / Unit | Pack |
|---------|---------------|---------------|------|
|---------|---------------|---------------|------|

Features

Conforms to IEC/EN 60947-4-1
CE & UL Certified
Thermal protection of circuits against overload, long starting times, and phase failure
Trip Class 10A
Trip Indication
Manual/Automatic Reset
Integrated auxiliary contacts 1 NO & 1 NC

Thermal Overload Relays For 3 Pole Mini Contactors

Class 10 A - Integrated auxiliary contacts 1 NO + 1 NC

| | | | |
|---------|-------------|------|---|
| 4170 80 | 0.1~0.16 A | 2090 | 1 |
| 4170 81 | 0.16~0.25 A | 2090 | 1 |
| 4170 82 | 0.25~0.4 A | 2090 | 1 |
| 4170 83 | 0.4~0.63 A | 2090 | 1 |
| 4170 84 | 0.63~1 A | 2090 | 1 |
| 4170 85 | 1~1.6 A | 2090 | 1 |
| 4170 86 | 1.6~2.5 A | 2090 | 1 |
| 4170 87 | 2.5~4 A | 2090 | 1 |
| 4170 88 | 4~6 A | 2090 | 1 |
| 4170 89 | 5~8 A | 2090 | 1 |
| 4170 90 | 6~9 A | 2090 | 1 |
| 4170 91 | 7~10 A | 2090 | 1 |
| 4170 92 | 9~13 A | 2090 | 1 |
| 4170 93 | 12~16 A | 2090 | 1 |



4170 88

Bold Cat.Nos are products normally available with Legrand (India) Stockists.
Cat.Nos that are not bold - delivery within 4 - 8 weeks from the date of order.
Bold packing quantity is our mandatory packing. Orders to be placed by Legrand (India) Stockist in multiples of the same.

Mini Thermal Overload Relays

RTX³ mini

Accessories for Mini Contactors CTX³

| Cat.Nos | Setting Range | MRP* ₹ / Unit | Pack |
|---------|---------------|------------------|------|
|---------|---------------|------------------|------|

Add on Auxiliary Blocks for Mini Contactors

High Thermal current - 10 A
lth: 10 A

Front Mounting

| | | | |
|---------|-------------|-----|----|
| 4171 50 | 1 NO + 1 NC | 610 | 10 |
| 4171 51 | 2 NO | 610 | 10 |
| 4171 52 | 2 NC | 610 | 10 |
| 4171 53 | 4 NO | 940 | 10 |
| 4171 54 | 3 NO + 1 NC | 940 | 10 |
| 4171 55 | 2 NO + 2 NC | 940 | 10 |
| 4171 56 | 1 NO + 3 NC | 940 | 10 |
| 4171 57 | 4 NC | 940 | 10 |

Side Mounting

| | | | |
|---------|------|-----|----|
| 4171 58 | 1 NO | 610 | 10 |
| 4171 59 | 1 NC | 610 | 10 |

Interlock Unit

| | | | |
|---------|--|-----|---|
| 4171 60 | Mechanical interlock for mini contactors | 980 | 5 |
|---------|--|-----|---|

Spare Coils

| | | | |
|---------|--------|------|---|
| 4171 70 | 24 V~ | 1090 | 5 |
| 4171 71 | 24 V= | 1480 | 5 |
| 4171 74 | 110 V~ | 1090 | 5 |
| 4171 76 | 230 V~ | 1090 | 5 |
| 4171 79 | 415 V~ | 1090 | 5 |

Power Contactors CTX³

Uncompromising Performance For Motor

Protection & Control

Range from 9A to 800A (AC3) Contactors

Features

Conforms to IEC/EN 60947-4-1

CE & UL Certified

Extra Mechanical life upto 15 Million

Extra Electrical life upto 2.5 Million

Extra Low Consumption

Compact size

integrated auxiliary contacts

Front safety Cover to prevent dust entry

Direct Clipping on Din Rail

Both Sides Terminal connection

Click fit accessories

Interlocking kits

Spare Coils

RoHS Complaint

3 Pole Contactors CTX³

9 A To 100 A Industrial Contactors

| Cat.Nos | Max. opt. current AC 3 | Max. opt. current AC 1 | Control voltage | MRP* ₹ / Unit | Pack |
|---------|------------------------|------------------------|-----------------|------------------|------|
|---------|------------------------|------------------------|-----------------|------------------|------|

CTX³ 22

With integrated auxiliary contacts

Power terminals: screw terminals

9 A - Integrated auxiliary contacts 1 NO + 1 NC

| | | | | | |
|---------|-----|------|--------|------|---|
| 4160 80 | 9 A | 25 A | 24 V~ | 1940 | 1 |
| 4160 81 | 9 A | 25 A | 24 V= | 3190 | 1 |
| 4160 82 | 9 A | 25 A | 48 V~ | 1940 | 1 |
| 4160 83 | 9 A | 25 A | 48 V= | 3190 | 1 |
| 4160 84 | 9 A | 25 A | 110 V~ | 1940 | 1 |
| 4160 86 | 9 A | 25 A | 230 V~ | 1940 | 1 |
| 4160 88 | 9 A | 25 A | 380 V~ | 1940 | 1 |
| 4160 89 | 9 A | 25 A | 415 V~ | 1940 | 1 |

* MRP - Maximum Retail Price Inclusive of all taxes including GST.

3 Pole Contactors CTX³

9 A to 100 A Industrial Contactors

| Cat.Nos | Max. opt. current AC 3 | Max. opt. current AC 1 | Control voltage | MRP* ₹ / Unit | Pack |
|---------|------------------------|------------------------|-----------------|------------------|------|
|---------|------------------------|------------------------|-----------------|------------------|------|

12 A - Integrated auxiliary contacts 1 NO + 1 NC

| | | | | | |
|---------|------|------|--------|------|---|
| 4160 90 | 12 A | 25 A | 24 V~ | 2190 | 1 |
| 4160 91 | 12 A | 25 A | 24 V= | 3450 | 1 |
| 4160 92 | 12 A | 25 A | 48 V~ | 2190 | 1 |
| 4160 93 | 12 A | 25 A | 48 V= | 3450 | 1 |
| 4160 94 | 12 A | 25 A | 110 V~ | 2190 | 1 |
| 4160 96 | 12 A | 25 A | 230 V~ | 2190 | 1 |
| 4160 98 | 12 A | 25 A | 380 V~ | 2190 | 1 |
| 4160 99 | 12 A | 25 A | 415 V~ | 2190 | 1 |

18 A - Integrated auxiliary contacts 1 NO + 1 NC

| | | | | | |
|---------|------|------|--------|------|---|
| 4161 00 | 18 A | 40 A | 24 V~ | 2580 | 1 |
| 4161 01 | 18 A | 40 A | 24 V= | 4200 | 1 |
| 4161 02 | 18 A | 40 A | 48 V~ | 2580 | 1 |
| 4161 03 | 18 A | 40 A | 48 V= | 4200 | 1 |
| 4161 04 | 18 A | 40 A | 110 V~ | 2580 | 1 |
| 4161 06 | 18 A | 40 A | 230 V~ | 2580 | 1 |
| 4161 08 | 18 A | 40 A | 380 V~ | 2580 | 1 |
| 4161 09 | 18 A | 40 A | 415 V~ | 2580 | 1 |

22 A - Integrated auxiliary contacts 1 NO + 1 NC

| | | | | | |
|---------|------|------|--------|------|---|
| 4161 10 | 22 A | 40 A | 24 V~ | 3190 | 1 |
| 4161 11 | 22 A | 40 A | 24 V= | 5400 | 1 |
| 4161 12 | 22 A | 40 A | 48 V~ | 3190 | 1 |
| 4161 13 | 22 A | 40 A | 48 V= | 5400 | 1 |
| 4161 14 | 22 A | 40 A | 110 V~ | 3190 | 1 |
| 4161 16 | 22 A | 40 A | 230 V~ | 3190 | 1 |
| 4161 18 | 22 A | 40 A | 380 V~ | 3190 | 1 |
| 4161 19 | 22 A | 40 A | 415 V~ | 3190 | 1 |

CTX³ 40

With integrated auxiliary contacts

Power terminals: screw terminals

32 A - Integrated auxiliary contacts 2 NO + 2 NC

| | | | | | |
|---------|------|------|--------|-------|---|
| 4161 20 | 32 A | 50 A | 24 V~ | 6670 | 1 |
| 4161 21 | 32 A | 50 A | 24 V= | 11540 | 1 |
| 4161 22 | 32 A | 50 A | 48 V~ | 6670 | 1 |
| 4161 23 | 32 A | 50 A | 48 V= | 11540 | 1 |
| 4161 24 | 32 A | 50 A | 110 V~ | 6670 | 1 |
| 4161 26 | 32 A | 50 A | 230 V~ | 6670 | 1 |
| 4161 28 | 32 A | 50 A | 380 V~ | 6670 | 1 |
| 4161 29 | 32 A | 50 A | 415 V~ | 6670 | 1 |

40 A - Integrated auxiliary contacts 2 NO + 2 NC

| | | | | | |
|---------|------|------|--------|-------|---|
| 4161 30 | 40 A | 60 A | 24 V~ | 9880 | 1 |
| 4161 31 | 40 A | 60 A | 24 V= | 14460 | 1 |
| 4161 32 | 40 A | 60 A | 48 V~ | 9880 | 1 |
| 4161 33 | 40 A | 60 A | 48 V= | 14460 | 1 |
| 4161 34 | 40 A | 60 A | 110 V~ | 9880 | 1 |
| 4161 36 | 40 A | 60 A | 230 V~ | 9880 | 1 |
| 4161 38 | 40 A | 60 A | 380 V~ | 9880 | 1 |
| 4161 39 | 40 A | 60 A | 415 V~ | 9880 | 1 |

CTX³ 65

With integrated auxiliary contacts

50 A - Integrated auxiliary contacts 2 NO + 2 NC

Screw terminals

| | | | | | |
|---------|------|------|--------|-------|---|
| 4161 40 | 50 A | 70 A | 24 V~ | 12080 | 1 |
| 4161 41 | 50 A | 70 A | 24 V= | 16640 | 1 |
| 4161 42 | 50 A | 70 A | 48 V~ | 12080 | 1 |
| 4161 43 | 50 A | 70 A | 48 V= | 16640 | 1 |
| 4161 44 | 50 A | 70 A | 110 V~ | 12080 | 1 |
| 4161 46 | 50 A | 70 A | 230 V~ | 12080 | 1 |
| 4161 48 | 50 A | 70 A | 380 V~ | 12080 | 1 |
| 4161 49 | 50 A | 70 A | 415 V~ | 12080 | 1 |

Bold Cat.Nos are products normally available with Legrand (India) Stockists.

Cat.Nos that are not bold - delivery within 4 - 8 weeks from the date of order.

Bold packing quantity is our mandatory packing. Orders to be placed by Legrand (India) Stockist in multiples of the same.

Legrand (India) Stockist in multiples of the same.



4171 55



4160 96



4161 26



4161 46

3 pole contactors CTX³ 9 A To 100 A Industrial Contactors

| Cat.Nos | Max. opt. current AC 3 | Max. opt. current AC 1 | Control voltage | MRP* ₹ / Unit | Pack |
|--|------------------------|------------------------|-----------------|---------------|------|
| 65 A - Integrated auxiliary contacts 2 NO + 2 NC Screw terminals | | | | | |
| 4161 60 | 65 A | 100 A | 24 V~ | 16060 | 1 |
| 4161 61 | 65 A | 100 A | 24 V= | 18700 | 1 |
| 4161 62 | 65 A | 100 A | 48 V~ | 16060 | 1 |
| 4161 63 | 65 A | 100 A | 48 V= | 18700 | 1 |
| 4161 64 | 65 A | 100 A | 110 V~ | 16060 | 1 |
| 4161 66 | 65 A | 100 A | 230 V~ | 16060 | 1 |
| 4161 68 | 65 A | 100 A | 380 V~ | 16060 | 1 |
| 4161 69 | 65 A | 100 A | 415 V~ | 16060 | 1 |

CTX³ 100

With integrated auxiliary contacts

75 A - Integrated auxiliary contacts 2 NO + 2 NC
Screw terminals

| | | | | | |
|---------|------|-------|--------|-------|---|
| 4161 80 | 75 A | 110 A | 24 V~ | 19940 | 1 |
| 4161 81 | 75 A | 110 A | 24 V= | 22370 | 1 |
| 4161 82 | 75 A | 110 A | 48 V~ | 19940 | 1 |
| 4161 83 | 75 A | 110 A | 48 V= | 22370 | 1 |
| 4161 84 | 75 A | 110 A | 110 V~ | 19940 | 1 |
| 4161 86 | 75 A | 110 A | 230 V~ | 19940 | 1 |
| 4161 88 | 75 A | 110 A | 380 V~ | 19940 | 1 |
| 4161 89 | 75 A | 110 A | 415 V~ | 19940 | 1 |

85 A - Integrated auxiliary contacts 2 NO + 2 NC
Screw terminals

| | | | | | |
|---------|------|-------|--------|-------|---|
| 4162 00 | 85 A | 135 A | 24 V~ | 20640 | 1 |
| 4162 01 | 85 A | 135 A | 24 V= | 23660 | 1 |
| 4162 02 | 85 A | 135 A | 48 V~ | 20640 | 1 |
| 4162 03 | 85 A | 135 A | 48 V= | 23660 | 1 |
| 4162 04 | 85 A | 135 A | 110 V~ | 20640 | 1 |
| 4162 06 | 85 A | 135 A | 230 V~ | 20640 | 1 |
| 4162 08 | 85 A | 135 A | 380 V~ | 20640 | 1 |
| 4162 09 | 85 A | 135 A | 415 V~ | 20640 | 1 |

100 A - Integrated auxiliary contacts 2 NO + 2 NC
Screw terminals

| | | | | | |
|---------|-------|-------|--------|-------|---|
| 4162 20 | 100 A | 160 A | 24 V~ | 25720 | 1 |
| 4162 21 | 100 A | 160 A | 24 V= | 28920 | 1 |
| 4162 22 | 100 A | 160 A | 48 V~ | 25720 | 1 |
| 4162 23 | 100 A | 160 A | 48 V= | 28920 | 1 |
| 4162 24 | 100 A | 160 A | 110 V~ | 25720 | 1 |
| 4162 26 | 100 A | 160 A | 230 V~ | 25720 | 1 |
| 4162 28 | 100 A | 160 A | 380 V~ | 25720 | 1 |
| 4162 29 | 100 A | 160 A | 415 V~ | 25720 | 1 |

3 Pole Contactors CTX³ 130 A To 800 A Industrial Contactors

CTX 150

With integrated auxiliary contacts

130 A - Integrated auxiliary contacts 2 NO + 2 NC
Screw terminals

| | | | | | |
|---------|-------|-------|--------------|-------|---|
| 4162 40 | 130 A | 160 A | 24 V~ | 38240 | 1 |
| 4162 41 | 130 A | 160 A | 24 V= | 42020 | 1 |
| 4162 42 | 130 A | 160 A | 48 V~ | 38240 | 1 |
| 4162 43 | 130 A | 160 A | 48 V= | 42020 | 1 |
| 4162 46 | 130 A | 160 A | 100-240 V~/= | 38240 | 1 |
| 4162 49 | 130 A | 160 A | 400-440 V~ | 38240 | 1 |

150 A - Integrated auxiliary contacts 2 NO + 2 NC
Screw terminals

| | | | | | |
|---------|-------|-------|-------|-------|---|
| 4162 60 | 150 A | 210 A | 24 V~ | 38760 | 1 |
| 4162 61 | 150 A | 210 A | 24 V= | 41470 | 1 |
| 4162 62 | 150 A | 210 A | 48 V~ | 38760 | 1 |
| 4162 63 | 150 A | 210 A | 48 V= | 41470 | 1 |

* MRP - Maximum Retail Price Inclusive of all taxes including GST.

3 Pole Contactors CTX³ 130 A To 800 A Industrial Contactors

| Cat.Nos | Max. opt. current AC 3 | Max. opt. current AC 1 | Control voltage | MRP* ₹ / Unit | Pack |
|---|------------------------|------------------------|-----------------|---------------|------|
| 150 A - Integrated auxiliary contacts 2 NO + 2 NC Screw terminals | | | | | |
| 4162 66 | 150 A | 210 A | 100-240 V~/= | 38760 | 1 |
| 4162 69 | 150 A | 210 A | 400-440 ~A | 38760 | 1 |

CTX³ 225

With integrated auxiliary contacts - Screw terminals

185 A - Integrated auxiliary contacts 2 NO + 2 NC

| | | | | | |
|---------|-------|-------|--------------|-------|---|
| 4162 80 | 185 A | 230 A | 24 V~/= | 48930 | 1 |
| 4162 82 | 185 A | 230 A | 48 V~/= | 48930 | 1 |
| 4162 86 | 185 A | 230 A | 100-240 V~/= | 44120 | 1 |
| 4162 89 | 185 A | 230 A | 380-450 V~ | 44120 | 1 |

225 A - Integrated auxiliary contacts 2 NO + 2 NC

| | | | | | |
|---------|-------|-------|--------------|-------|---|
| 4162 90 | 225 A | 275 A | 24 V~/= | 50500 | 1 |
| 4162 92 | 225 A | 275 A | 48 V~/= | 50500 | 1 |
| 4162 96 | 225 A | 275 A | 100-240 V~/= | 44650 | 1 |
| 4162 99 | 225 A | 275 A | 380-450 V~ | 44650 | 1 |

CTX³ 400

With integrated auxiliary contacts - Screw terminals

265 A - Integrated auxiliary contacts 2 NO + 2 NC

| | | | | | |
|---------|-------|-------|--------------|-------|---|
| 4163 06 | 265 A | 300 A | 100-240 V~/= | 58550 | 1 |
| 4163 09 | 265 A | 300 A | 380-450 V~ | 58550 | 1 |

330 A - Integrated auxiliary contacts 2 NO + 2 NC

| | | | | | |
|---------|-------|-------|--------------|-------|---|
| 4163 16 | 330 A | 350 A | 100-240 V~/= | 68290 | 1 |
| 4163 19 | 330 A | 350 A | 380-450 V~ | 68290 | 1 |

400 A - Integrated auxiliary contacts 2 NO + 2 NC

| | | | | | |
|---------|-------|-------|--------------|-------|---|
| 4163 26 | 400 A | 450 A | 100-240 V~/= | 83530 | 1 |
| 4163 29 | 400 A | 450 A | 380-450 V~ | 83530 | 1 |

CTX³ 800

With integrated auxiliary contacts - Screw terminals

500 A - Integrated auxiliary contacts 2 NO + 2 NC

| | | | | | |
|---------|-------|-------|--------------|--------|---|
| 4163 36 | 500 A | 580 A | 200-240 V~/= | 125520 | 1 |
| 4163 39 | 500 A | 580 A | 380-450 V~ | 125520 | 1 |

630 A - Integrated auxiliary contacts 2 NO + 2 NC

| | | | | | |
|---------|-------|-------|--------------|--------|---|
| 4163 46 | 630 A | 660 A | 200-240 V~/= | 178730 | 1 |
| 4163 49 | 630 A | 660 A | 380-450 V~ | 178730 | 1 |

800 A - Integrated auxiliary contacts 2 NO + 2 NC

| | | | | | |
|---------|-------|-------|--------------|--------|---|
| 4163 56 | 800A | 900 A | 200-240 V~/= | 266540 | 1 |
| 4163 59 | 800 A | 900 A | 380-450 V~ | 266540 | 1 |

Bold Cat.Nos are products normally available with Legrand (India) Stockists. Cat.Nos that are not bold - delivery within 4 - 8 weeks from the date of order. Bold packing quantity is our mandatory packing. Orders to be placed by Legrand (India) Stockist in multiples of the same.



4161 86



4162 96



4162 46



4163 56

Thermal Relays RTX³ For CTX³ 3 Pole Industrial Contactors

| Cat.Nos | I min. (A) | I max. (A) | MRP* ₹ / Unit | Pack |
|---------|---------------|---------------|---------------------|------|
|---------|---------------|---------------|---------------------|------|

Features

Conforms to IEC/EN 60947-4-1

CE & UL Certified

Thermal protection of circuits against overload, long starting times, and phase failure

Trip Class 10A

Trip Indication

Manual/Automatic Reset

Integrated Auxiliary Contacts 1 NO & 1 NC

Standard type:

- Overload detecting bimetal is used all for three phases

Differential type:

- Standard type characteristics + phase failure protection

Thermal Overload Relays

Class 10A - Integrated auxiliary contacts 1 NO + 1 NC

RTX³ 40 - for CTX³ 22 and 40

Standard type with screw terminals

| Cat.Nos | I min. (A) | I max. (A) | MRP* ₹ / Unit | Pack |
|---------|---------------|---------------|---------------------|------|
| 4166 40 | 0.1 | 0.16 | 2600 | 1 |
| 4166 41 | 0.16 | 0.25 | 2600 | 1 |
| 4166 42 | 0.25 | 0.4 | 2600 | 1 |
| 4166 43 | 0.4 | 0.63 | 2600 | 1 |
| 4166 44 | 0.63 | 1 | 2600 | 1 |
| 4166 45 | 1 | 1.6 | 2600 | 1 |
| 4166 46 | 1.6 | 2.5 | 2600 | 1 |
| 4166 47 | 2.5 | 4 | 2600 | 1 |
| 4166 48 | 4 | 6 | 2600 | 1 |
| 4166 49 | 5 | 8 | 2600 | 1 |

RTX³ 40 - for CTX³ 22 and 40

Standard type with screw terminals

| Cat.Nos | I min. (A) | I max. (A) | MRP* ₹ / Unit | Pack |
|---------|---------------|---------------|---------------------|------|
| 4166 50 | 6 | 9 | 2600 | 1 |
| 4166 51 | 7 | 10 | 2600 | 1 |
| 4166 52 | 9 | 13 | 2600 | 1 |
| 4166 53 | 12 | 18 | 2600 | 1 |
| 4166 54 | 16 | 22 | 2710 | 1 |
| 4166 55 | 18 | 25 | 2750 | 1 |
| 4166 56 | 22 | 32 | 3120 | 1 |
| 4166 57 | 28 | 40 | 3360 | 1 |



4167 31



4167 65

Thermal Relays RTX³ For CTX³ 3 Pole Industrial Contactors

| Cat.Nos | I min. (A) | I max. (A) | MRP* ₹ / Unit | Pack |
|---------|---------------|---------------|---------------------|------|
|---------|---------------|---------------|---------------------|------|

RTX³ 40 - for CTX³ 22 and 40

Differential type with screw terminals

| Cat.Nos | I min. (A) | I max. (A) | MRP* ₹ / Unit | Pack |
|---------|---------------|---------------|---------------------|------|
| 4166 60 | 0.1 | 0.16 | 3170 | 1 |
| 4166 61 | 0.16 | 0.25 | 3170 | 1 |
| 4166 62 | 0.25 | 0.4 | 3170 | 1 |
| 4166 63 | 0.4 | 0.63 | 3210 | 1 |
| 4166 64 | 0.63 | 1 | 3210 | 1 |
| 4166 65 | 1 | 1.6 | 3210 | 1 |
| 4166 66 | 1.6 | 2.5 | 3210 | 1 |
| 4166 67 | 2.5 | 4 | 3210 | 1 |
| 4166 68 | 4 | 6 | 3220 | 1 |
| 4166 69 | 5 | 8 | 3220 | 1 |
| 4166 70 | 6 | 9 | 3220 | 1 |
| 4166 71 | 7 | 10 | 3220 | 1 |
| 4166 72 | 9 | 13 | 3220 | 1 |
| 4166 73 | 12 | 18 | 3370 | 1 |
| 4166 74 | 16 | 22 | 3370 | 1 |
| 4166 75 | 18 | 25 | 3370 | 1 |
| 4166 76 | 22 | 32 | 4110 | 1 |
| 4166 77 | 28 | 40 | 4110 | 1 |

RTX³ 65 - for CTX³ 65

Standard type with screw terminals

| Cat.Nos | I min. (A) | I max. (A) | MRP* ₹ / Unit | Pack |
|---------|---------------|---------------|---------------------|------|
| 4166 83 | 9 | 13 | 5230 | 1 |
| 4166 84 | 12 | 18 | 5230 | 1 |
| 4166 85 | 16 | 22 | 5230 | 1 |
| 4166 86 | 18 | 25 | 5230 | 1 |
| 4166 87 | 24 | 36 | 5230 | 1 |
| 4166 88 | 28 | 40 | 5230 | 1 |
| 4166 89 | 34 | 50 | 5230 | 1 |
| 4166 90 | 45 | 65 | 5230 | 1 |

RTX³ 100 - for CTX³ 100

Standard type with screw terminals

| Cat.Nos | I min. (A) | I max. (A) | MRP* ₹ / Unit | Pack |
|---------|---------------|---------------|---------------------|------|
| 4167 23 | 18 | 25 | 8460 | 1 |
| 4167 24 | 24 | 36 | 8460 | 1 |
| 4167 25 | 28 | 40 | 8460 | 1 |
| 4167 26 | 34 | 50 | 8460 | 1 |
| 4167 27 | 45 | 65 | 8460 | 1 |
| 4167 28 | 54 | 75 | 8460 | 1 |
| 4167 29 | 63 | 85 | 8460 | 1 |
| 4167 30 | 70 | 95 | 8460 | 1 |
| 4167 31 | 80 | 100 | 8460 | 1 |

RTX³ 150 - for CTX³ 150

Standard type with screw terminals

| Cat.Nos | I min. (A) | I max. (A) | MRP* ₹ / Unit | Pack |
|---------|---------------|---------------|---------------------|------|
| 4167 60 | 45 | 65 | 12450 | 1 |
| 4167 61 | 54 | 75 | 12450 | 1 |
| 4167 62 | 63 | 85 | 12450 | 1 |
| 4167 63 | 80 | 105 | 12450 | 1 |
| 4167 64 | 95 | 130 | 12450 | 1 |
| 4167 65 | 110 | 150 | 12450 | 1 |

* MRP - Maximum Retail Price Inclusive of all taxes including GST.

Bold Cat.Nos are products normally available with Legrand (India) Stockists. Cat.Nos that are not bold - delivery within 4 - 8 weeks from the date of order. Bold packing quantity is our mandatory packing. Orders to be placed by Legrand (India) Stockist in multiples of the same.

Thermal Relays RTX³ For CTX³ 3 Pole Industrial Contactors

| Cat.Nos | Description | MRP* ₹ / Unit | Pack |
|---------|-------------|------------------|------|
|---------|-------------|------------------|------|

Separate Mounting Units

To mount the relays separately from contactors, on DIN rail or panel by fixing screws

| | | | |
|---------|---|------|---|
| 4165 91 | For RTX ³ 40 up to 32 A | 970 | 1 |
| 4165 92 | For RTX ³ 40 40 A | 970 | 1 |
| 4165 93 | For RTX ³ 65 with screw terminals | 1200 | 1 |
| 4165 94 | For RTX ³ 65 with cage terminals | 1200 | 1 |
| 4165 95 | For RTX ³ 100 with screw terminals | 1520 | 1 |
| 4165 96 | For RTX ³ 100 with cage terminals | 1520 | 1 |
| 4165 97 | For RTX ³ 150 with screw terminals | 2410 | 1 |
| 4165 98 | For RTX ³ 150 with cage terminals | 2410 | 1 |

Thermal Overload Relays

Class 10 A - Integrated auxiliary contacts 1 NO + 1 NC

| Cat.Nos | I min. (A) | I max. (A) | MRP* ₹ / Unit | Pack |
|---------|------------|------------|------------------|------|
|---------|------------|------------|------------------|------|

RTX³ 225 - for CTX³ 225

Differential type with screw terminals

| | | | | |
|---------|-----|-----|-------|---|
| 4167 80 | 65 | 100 | 16920 | 1 |
| 4167 81 | 85 | 125 | 16920 | 1 |
| 4167 82 | 100 | 160 | 18760 | 1 |
| 4167 83 | 120 | 185 | 18760 | 1 |
| 4167 84 | 160 | 240 | 19480 | 1 |



4167 84

RTX³ 400 - for CTX³ 400

Differential type with screw terminals

| | | | | |
|---------|-----|-----|-------|---|
| 4167 86 | 85 | 125 | 24840 | 1 |
| 4167 87 | 100 | 160 | 24840 | 1 |
| 4167 88 | 120 | 185 | 24840 | 1 |
| 4167 89 | 160 | 240 | 24840 | 1 |
| 4167 90 | 200 | 330 | 24840 | 1 |
| 4167 91 | 260 | 400 | 24840 | 1 |

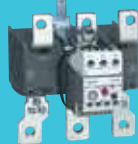

4167 91

RTX³ 800 - for CTX³ 800

Differential type with screw terminals

| | | | | |
|---------|-----|-----|-------|---|
| 4167 92 | 200 | 300 | 38630 | 1 |
| 4167 93 | 260 | 400 | 38630 | 1 |
| 4167 94 | 400 | 630 | 38630 | 1 |
| 4167 95 | 520 | 800 | 38630 | 1 |



4164 36

4-pole contactors CTX³ 40 A to 900 A Industrial Contactors and Spare Coils

| Cat.Nos | Max. opt. current AC 1 | Max. opt. current AC 3 | Control voltage | MRP* ₹ / Unit | Pack |
|---------|------------------------|------------------------|-----------------|------------------|------|
|---------|------------------------|------------------------|-----------------|------------------|------|

Contactors CTX³

Power terminals: screw terminals

Without integrated auxiliary contact

| | | | | | |
|---------|-------|------|--------|-------|---|
| 4164 26 | 40 A | 22 A | 230 V~ | 4190 | 1 |
| 4164 36 | 60 A | 40 A | 230 V~ | 10420 | 1 |
| 4164 46 | 100 A | 65 A | 230 V~ | 17890 | 1 |
| 4164 56 | 135 A | 85 A | 230 V~ | 22010 | 1 |



4164 56

* MRP - Maximum Retail Price Inclusive of all taxes including GST.

4-Pole Contactors CTX³ 40 A to 900 A Industrial Contactors and Spare Coils

| Cat.Nos | Max. opt. current AC 1 | Max. opt. current AC 3 | Control voltage | MRP* ₹ / Unit | Pack |
|---------|------------------------|------------------------|-----------------|------------------|------|
|---------|------------------------|------------------------|-----------------|------------------|------|

With Integrated Auxiliary Contacts

Auxiliary contacts: 2 NO + 2 NC

| | | | | | |
|---------|-------|-------|--------------|--------|---|
| 4164 66 | 165 A | 130 A | 100-240 V~/= | 36470 | 1 |
| 4164 76 | 250 A | 150 A | 100-240 V~/= | 49010 | 1 |
| 4164 86 | 330 A | 225 A | 100-240 V~/= | 54530 | 1 |
| 4164 96 | 420 A | 330 A | 100-240 V~/= | 100830 | 1 |
| 4165 06 | 500 A | 400 A | 100-240 V~/= | 110330 | 1 |
| 4165 16 | 750 A | 630 A | 200-240 V~/= | 221780 | 1 |
| 4165 26 | 900 A | 800 A | 200-240 V~/= | 268130 | 1 |



4164 86

Spare Coils for CTX³ 4P Contactors

| Cat.Nos | Description | MRP* ₹ / Unit | Pack |
|---------|-------------|------------------|------|
|---------|-------------|------------------|------|

Control voltage 230 V~

| | | | |
|---------|--|-------|---|
| 4165 46 | For CTX ³ 40 A to 60 A (AC-1) | 2050 | 1 |
| 4165 56 | For CTX ³ 100 A to 135 A (AC-1) | 2440 | 1 |
| 4165 66 | For CTX ³ 165 A to 330 A (AC-1) | 12810 | 1 |
| 4165 76 | For CTX ³ 420 A to 500 A (AC-1) | 23930 | 1 |
| 4165 86 | For CTX ³ 750 A to 900 A (AC-1) | 35900 | 1 |

CTX³ Add-On Auxiliary Contact Blocks

Front Mounting

For CTX³ 3P form 9 A to 150 A (AC-3) and CTX³ 4P from 40 A to 135 A (AC-1) - 2 and 4 pole - lth: 16 A

| | | | |
|---------|-------------|------|----|
| 4168 50 | 1 NO + 1 NC | 650 | 10 |
| 4168 51 | 2 NO | 650 | 10 |
| 4168 52 | 2 NC | 650 | 10 |
| 4168 53 | 4 NO | 1030 | 10 |
| 4168 54 | 3 NO + 1 NC | 1030 | 10 |
| 4168 55 | 2 NO + 2 NC | 1030 | 10 |
| 4168 56 | 1 NO + 3 NC | 1030 | 10 |
| 4168 57 | 4 NC | 1030 | 10 |



4168 50



4168 55

Side Mounting

2 pole - Mounting on both sides

| | | | |
|---------|---|------|----|
| 4168 58 | For CTX ³ 3P Form 9 A to 150 A (AC-3) 1 NO + 1 NC - lth: 16 A | 1120 | 10 |
| 4168 59 | For CTX ³ 3P Form 185 A to 800 A (AC-3) and CTX ³ 4P from 165 A to 900 A (AC-1) 1 NO + 1 NC - lth: 16 A | 1120 | 10 |
| 4168 49 | For CTX ³ 4P From 40 A to 135 A (AC-1) 1 NO + 1 NC - lth: 16 A | 1120 | 10 |

Bold Cat.Nos are products normally available with Legrand (India) Stockists. Cat.Nos that are not bold - delivery within 4 - 8 weeks from the date of order. Bold packing quantity is our mandatory packing. Orders to be placed by Legrand (India) Stockist in multiples of the same.

4-Pole Contactors CTX³

40 A to 900 A Industrial Contactors and Spare Coils



| Cat.Nos | Description | MRP* ₹ / Unit | Pack |
|---------|-------------|------------------|------|
|---------|-------------|------------------|------|

CTX³ Time Delay Blocks

For CTX³ 3P from 9 A to 150 A (AC-3)

Time delay: 1 to 30 s

Front mounting

On Delay

| | | | |
|---------|------------|------|---|
| 4168 70 | 24-48 V~/= | 3000 | 1 |
| 4168 71 | 110-230 V~ | 3000 | 1 |

Off Delay

| | | | |
|---------|------------|------|---|
| 4168 72 | 24-48 V~/= | 4110 | 1 |
| 4168 73 | 110-230 V~ | 3920 | 1 |

CTX³

capacitor Switching Units Cat.Nos 4168 74/75/76/77
Capacitor Unit Is Connected To The Terminals Of The Contactor To Reduce The High Inrush Current.

IEC 60947-4-1 AC 6b

| Type | Contactor | | Maximum operating power (kVAr) | | | Max. Peak current (A) |
|---|----------------------|-------|--------------------------------|-------------|-------------|-----------------------|
| | | | 220 - 240 V | 400 - 480 V | 500 - 550 V | |
| 4168 74 | CTX ³ 22 | 9 A | 5 | 9.7 | 14 | 560 |
| | CTX ³ 22 | 12 A | 6.7 | 12.5 | 18 | 560 |
| | CTX ³ 22 | 18 A | 8.5 | 16.7 | 24 | 850 |
| | CTX ³ 22 | 22 A | 10 | 18 | 26 | 1250 |
| | CTX ³ 40 | 32 A | 15 | 25 | 36 | 1900 |
| | CTX ³ 40 | 40 A | 20 | 33.3 | 48 | 2160 |
| 4168 75/76 | CTX ³ 65 | 50 A | 20 | 40 | 58 | 2160 |
| | CTX ³ 65 | 65 A | 25 | 45.7 | 66 | 3040 |
| 4168 77 | CTX ³ 100 | 75 A | 29.7 | 54 | 78 | 3040 |
| | CTX ³ 100 | 85 A | 35 | 60 | 92 | 3040 |
| | CTX ³ 100 | 100 A | 37 | 62 | 94 | 3040 |
| Without Capacitor Switching Unit as per IEC 60947-4-1 AC 6b | CTX ³ 150 | 150 A | | 70 | | 3300 |
| | CTX ³ 225 | 185 A | | 84 | 120 | 3500 |
| | CTX ³ 225 | 225 A | | 115 | 130 | 4000 |
| | CTX ³ 400 | 265 A | | 125 | 140 | 5000 |
| | CTX ³ 400 | 330 A | | 139 | 185 | 6500 |
| | CTX ³ 400 | 400 A | | 185 | 195 | 8000 |
| | CTX ³ 800 | 500 A | | 220 | 330 | 10000 |
| | CTX ³ 800 | 630 A | | 291 | 340 | 12000 |
| | CTX ³ 800 | 800 A | | 369 | 370 | 14200 |

Note:

- When the switch is closed capacitor must be discharged before recharged. (Maximum residual voltage at terminals ≤ 50 V)
- To prevent short current, gG type fuse must be 1.5 - 2 times than rated current

* MRP - Maximum Retail Price Inclusive of all taxes including GST.

CTX³ Accessories

| Cat.Nos | Description | MRP* ₹ / Unit | Pack |
|---------|-------------|------------------|------|
|---------|-------------|------------------|------|

CTX³ Capacitor Switching Units

AC-6b

Operating power from 9.7 kVAr to 62 kVAr (400/440 V)

| | | | |
|---------|--|------|---|
| 4168 74 | For contactors CTX ³ 3P from 9 to 40 A, upto 33.3 kVAr at 440 V / 48 kVAr at 525 V | 2840 | 1 |
| 4168 75 | For contactors CTX ³ 3P 50 and 65 A with screw terminals upto 45.7 kVAr at 440 V / 66 kVAr at 525 V | 3870 | 1 |
| 4168 76 | For contactors CTX ³ 3P 50 and 65 A with cage terminals upto 45.7 kVAr at 440 V / 66 kVAr at 525 V | 4190 | 1 |
| 4168 77 | For contactors CTX ³ 3P 75 to 100 A with screw terminals upto 62 kVAr at 440 V / 94 kVAr at 525 V | 4190 | 1 |

CTX³ Interlocking

Component parts for assembling by customer
Horizontal mounting

Interlock Units

| | | | |
|---------|---|------|---|
| 4168 79 | Mechanical interlocks for CTX ³ 4P from 40 to 135 A (AC-1) | 1700 | 5 |
|---------|---|------|---|

Interlock Units

| | | | |
|---------|---|------|---|
| 4168 80 | Mechanical interlocks for CTX ³ 3P from 9 to 150 A Provides 2 NC contacts for use in electrical interlocking | 3450 | 1 |
| 4168 87 | Mechanical interlocks for CTX ³ 3P from 185 to 400 A and CTX ³ 4P from 165 to 500 A | 5980 | 1 |

Interlock Units

| | | | |
|---------|---|------|---|
| 4168 88 | Mechanical interlocks for CTX ³ 3P from 500 to 800 A | 8000 | 1 |
| 4168 89 | Mechanical interlocks for CTX ³ 4P from 750 to 900 A | 8460 | 1 |

Wire Kits

Used for making reversing between two 3P contactors

| | | | |
|---------|--------------------------|------|---|
| 4168 82 | For CTX ³ 22 | 1750 | 5 |
| 4168 83 | For CTX ³ 40 | 2360 | 5 |
| 4168 84 | For CTX ³ 65 | 2900 | 5 |
| 4168 85 | For CTX ³ 100 | 4860 | 5 |

Bold Cat.Nos are products normally available with Legrand (India) Stockists. Cat.Nos that are not bold - delivery within 4 - 8 weeks from the date of order. Bold packing quantity is our mandatory packing. Orders to be placed by Legrand (India) Stockist in multiples of the same.

CTX³ Accessories



4168 91



4168 97



4168 40

| Cat.Nos | Description | MRP* ₹ / Unit | Pack |
|---------|-------------|------------------|------|
|---------|-------------|------------------|------|

Boxes for Motor Starter

For CTX³ 22 equipped with RTX³ 40 (0.1 - 22 A)

| | | | |
|---------|---------------------|------|---|
| 4168 90 | Without pushbuttons | 4440 | 1 |
| 4168 91 | With pushbuttons | 5440 | 1 |

CTX³ Transient Voltage Suppressor Blocks

Absorbs the surge arisen out of the coil of the contactor

| | | | |
|---------|--------------|-----|----|
| 4168 95 | 24-48 V~/= | 860 | 10 |
| 4168 96 | 100-125 V~/= | 860 | 10 |
| 4168 97 | 200-240 V~/= | 860 | 10 |
| 4168 98 | 380-400 V~ | 860 | 10 |

CTX³ Terminals Covers

| | | | |
|---------|--|------|---|
| 4168 42 | For CTX ³ 3P from 185 to 225 A (AC-3) | 780 | 5 |
| 4168 43 | For CTX ³ 3P from 265 to 400 A (AC-3) | 1160 | 5 |
| 4168 44 | For CTX ³ 3P from 500 to 900 A (AC-3) | 1760 | 5 |
| 4168 45 | For CTX ³ 4P from 165 to 330 A (AC-1) | 970 | 5 |
| 4168 46 | For CTX ³ 4P from 420 to 500 A (AC-1) | 1480 | 5 |
| 4168 47 | For CTX ³ 4P from 750 to 900 A (AC-1) | 2500 | 5 |

CTX³ Safety Front Cover

| | | | |
|---------|--|-----|----|
| 4168 40 | For CTX ³ 3P from 9 to 150 A (AC-3) and CTX ³ 4P from 40 to 135 A (AC-1) | 50 | 50 |
| 4168 41 | For CTX ³ 3P from 85 to 800 A (AC-3) and CTX 4P from 165 to 900 A (AC-1) | 200 | 50 |

Distant Reset Flexible Cables for Thermal Relays

| | | | |
|---------|--------|------|---|
| 4168 92 | 400 mm | 1460 | 1 |
| 4168 93 | 500 mm | 1590 | 1 |
| 4168 94 | 600 mm | 1620 | 1 |

CTX³ spare coils

Spare Coils for CTX³ 3P Contactors

For CTX³ 22

| | | | |
|---------|--------|------|---|
| 4169 00 | 24 V~ | 1100 | 5 |
| 4169 02 | 48 V~ | 1100 | 5 |
| 4169 04 | 110 V~ | 1100 | 5 |
| 4169 06 | 230 V~ | 1100 | 5 |
| 4169 08 | 380 V~ | 1100 | 5 |
| 4169 09 | 415 V~ | 1100 | 5 |

* MRP - Maximum Retail Price Inclusive of all taxes including GST.
 ■ Price available on request.

CTX³ Accessories

| Cat.Nos | Description | MRP* ₹ / Unit | Pack |
|---------|-------------|------------------|------|
|---------|-------------|------------------|------|

For CTX³ 40

| | | | |
|---------|--------|------|---|
| 4169 20 | 24 V~ | 1100 | 5 |
| 4169 21 | 24 V= | 1100 | 5 |
| 4169 22 | 48 V~ | 1100 | 5 |
| 4169 23 | 48 V= | 1100 | 5 |
| 4169 24 | 110 V~ | 1100 | 5 |
| 4169 26 | 230 V~ | 1100 | 5 |
| 4169 28 | 380 V~ | 1100 | 5 |
| 4169 29 | 415 V~ | 1100 | 5 |

For CTX³ 65

| | | | |
|---------|--------|------|---|
| 4169 30 | 24 V~ | 1690 | 5 |
| 4169 31 | 24 V= | 1690 | 5 |
| 4169 32 | 48 V~ | 1690 | 5 |
| 4169 33 | 48 V= | 1690 | 5 |
| 4169 34 | 110 V~ | 1690 | 5 |
| 4169 36 | 230 V~ | 1690 | 5 |
| 4169 38 | 380 V~ | 1690 | 5 |
| 4169 39 | 415 V~ | 1690 | 5 |

For CTX³ 100

| | | | |
|---------|--------|------|---|
| 4169 40 | 24 V~ | 2070 | 3 |
| 4169 41 | 24 V= | 2070 | 3 |
| 4169 42 | 48 V~ | 2070 | 3 |
| 4169 43 | 48 V= | 2070 | 3 |
| 4169 44 | 110 V~ | 2070 | 3 |
| 4169 46 | 230 V~ | 2070 | 3 |
| 4169 48 | 380 V~ | 2070 | 3 |
| 4169 49 | 415 V~ | 2070 | 3 |

For CTX³ 150

| | | | |
|---------|--------------|------|---|
| 4169 50 | 24 V~ | 7820 | 1 |
| 4169 51 | 24 V= | 7820 | 1 |
| 4169 52 | 48 V~ | 7820 | 1 |
| 4169 53 | 48 V= | 7820 | 1 |
| 4169 56 | 100-240 V~/= | 7820 | 1 |
| 4169 59 | 400-440 V~ | 7820 | 1 |

Bold Cat.Nos are products normally available with Legrand (India) Stockists. Cat.Nos that are not bold - delivery within 4 - 8 weeks from the date of order. Bold packing quantity is our mandatory packing. Orders to be placed by Legrand (India) Stockist in multiples of the same.

Auxillary Contactor / Control Relays CTX³



4169 66

| Cat.Nos | Description | MRP* ₹ / Unit | Pack |
|---------|-------------|------------------|------|
|---------|-------------|------------------|------|

For CTX³ 225

| | | | |
|---------|--------------|-------|---|
| 4169 60 | 24 V~/= | 11320 | 1 |
| 4169 62 | 48 V~/= | 11320 | 1 |
| 4169 66 | 100-240 V~/= | 11320 | 1 |
| 4169 69 | 400-440 V~ | 11320 | 1 |

For CTX³ 400

| | | | |
|---------|--------------|-------|---|
| 4169 76 | 100-240 V~/= | 17020 | 1 |
| 4169 79 | 380-450 V~ | 17020 | 1 |

For CTX³ 800

| | | | |
|---------|--------------|-------|---|
| 4169 86 | 200-240 V~/= | 37050 | 1 |
| 4169 89 | 380-450 V~ | 37050 | 1 |

Auxillary Contactor / Control Relays CTX³

4 pole

Conform to IEC 60 947-1, IEC 60 947-4-1 and IEC 60 947-5-1 for the auxiliary contacts

CE & UL Certified

Ultra High Ith = 10 A

Ultra Low consumption coil

Click fit accessories

Spare Coils available

RoHS Complaint

CTX³ Control Relays

4 NO

| | | | |
|---------|--------|------|---|
| 4168 00 | 24 V~ | 2220 | 1 |
| 4168 01 | 24 V= | 3370 | 1 |
| 4168 02 | 48 V~ | 2220 | 1 |
| 4168 03 | 48 V= | 3370 | 1 |
| 4168 04 | 110 V~ | 2220 | 1 |
| 4168 06 | 230 V~ | 2220 | 1 |
| 4168 09 | 415 V~ | 2220 | 1 |

3 NO + 1 NC

| | | | |
|---------|--------|------|---|
| 4168 10 | 24 V~ | 2220 | 1 |
| 4168 11 | 24 V= | 3370 | 1 |
| 4168 12 | 48 V~ | 2220 | 1 |
| 4168 13 | 48 V= | 3370 | 1 |
| 4168 14 | 110 V~ | 2220 | 1 |
| 4168 16 | 230 V~ | 2220 | 1 |
| 4168 19 | 415 V~ | 2220 | 1 |



4168 10

* MRP - Maximum Retail Price Inclusive of all taxes including GST.

Accessories for Auxiliary Contactor / Control Relays

| Cat.Nos | Description | MRP* ₹ / Unit | Pack |
|---------|-------------|------------------|------|
|---------|-------------|------------------|------|

2 NO + 2 NC

| | | | |
|---------|--------|------|---|
| 4168 20 | 24 V~ | 2220 | 1 |
| 4168 21 | 24 V= | 3400 | 1 |
| 4168 22 | 48 V~ | 2220 | 1 |
| 4168 23 | 48 V= | 3370 | 1 |
| 4168 24 | 110 V~ | 2220 | 1 |
| 4168 26 | 230 V~ | 2220 | 1 |
| 4168 29 | 415 V~ | 2220 | 1 |

High Thermal Current - 10 A

Ith : 10 A

Front Mounting

| | | | |
|---------|-------------|-----|----|
| 4171 50 | 1 NO + 1 NC | 610 | 10 |
| 4171 51 | 2 NO | 610 | 10 |
| 4171 52 | 2 NC | 610 | 10 |
| 4171 53 | 4 NO | 940 | 10 |
| 4171 54 | 3 NO + 1 NC | 940 | 10 |
| 4171 55 | 2 NO + 2 NC | 940 | 10 |
| 4171 56 | 1 NO + 3 NC | 940 | 10 |
| 4171 57 | 4 NC | 940 | 10 |

Side Mounting

| | | | |
|---------|------|-----|----|
| 4171 58 | 1 NO | 610 | 10 |
| 4171 59 | 1 NC | 610 | 10 |

Interlock Unit

| | | | |
|---------|----------------------|-----|---|
| 4171 60 | Mechanical Interlock | 980 | 5 |
|---------|----------------------|-----|---|

Spare Coils

| | | | |
|---------|--------|------|---|
| 4171 70 | 24 V~ | 1090 | 5 |
| 4171 71 | 24 V= | 1480 | 5 |
| 4171 74 | 110 V~ | 1090 | 5 |
| 4171 76 | 230 V~ | 1090 | 5 |
| 4171 79 | 415 V~ | 1090 | 5 |

Bold Cat.Nos are products normally available with Legrand (India) Stockists. Cat.Nos that are not bold - delivery within 4 - 8 weeks from the date of order. **Bold packing quantity** is our mandatory packing. Orders to be placed by Legrand (India) Stockist in multiples of the same.

CX³

EMS (Energy Management System)

Smart Energy Management, Simplified



CX³ EMS is a compact modular system for local or remote monitoring and control of electrical installations.

Features

- Energy measurement for single & three-phase networks
- Modbus RS-485 & Ethernet communication

Benefits

- Better energy visibility and cost control
- Improved operational reliability with real-time alerts



Scan to know more about the product.

CX³ Contactors

| Cat.Nos | Description | MRP* ₹ / Unit | Pack |
|---------|-------------|------------------|------|
|---------|-------------|------------------|------|

Power Contactors CX³

Conform to IEC/EN 61095
Space for power supply busbar on top (up to 25 A)

| | | | |
|----------------|---------------------|-------|---|
| 4125 44 | 25 A 2 NO contactor | 3260 | 1 |
| 4125 45 | 40 A 2 NO contactor | 5560 | 1 |
| 4125 47 | 63 A 2 NO contactor | 6470 | 1 |
| 4125 48 | 63 A 2 NC contactor | 6470 | 1 |
| 4125 49 | 40 A 3 NO contactor | 9300 | 1 |
| 4125 50 | 63 A 3 NO contactor | 10500 | 1 |
| 4125 51 | 25 A 4 NO contactor | 3840 | 1 |
| 4125 53 | 40 A 4 NO contactor | 9810 | 1 |
| 4125 56 | 63 A 4 NO contactor | 11610 | 1 |
| 4125 57 | 63 A 4 NC contactor | 11720 | 1 |

Signalling Auxiliaries For Contactors

Auxiliary Changeover Switch

| | | | |
|---------|--------------------------------------|------|---|
| 4124 29 | For 1 module contactors 16 A to 25 A | 4770 | 1 |
| 4124 30 | For 2 module contactors 25 A | 4790 | 1 |

* MRP - Maximum Retail Price Inclusive of all taxes including GST.



4173 08

MPCBs MPX³

| Cat.Nos | Rated 3Ph Motor | Magnetic release operating current (A) | MRP* ₹ / Unit | Pack |
|---------|-----------------|--|---------------|------|
|---------|-----------------|--|---------------|------|

Motor Protection Circuit Breakers From 0.16 A To 100 A Upto 45 KW

Maximum Efficiency In A Compact Unit

Conform to IEC 60947-1, IEC 60947-2, IEC 60947-4

Adjustable thermal release

Magnetic Release 13 le max

High breaking capacity

toggle handle

Fixing on rail or by screw

Wide Range Of Accessories

Undervoltage Release

Shunt Release

Auxiliary Contacts

IP 65 Enclosure

Thermal Magnetic MPCBs

Adjustable thermal release Magnetic release 13 le max.

MPX³ 32S - 3P

Standard breaking capacity with toggle handle

Fixing on rail □

415 V breaking capacity Icu (kA) - 100

| Cat.Nos | Rated 3Ph Motor (KW) | Thermal release adj. range (A) | Magnetic release operating current (A) | MRP* ₹ / Unit | Pack |
|---------|----------------------|--------------------------------|--|---------------|------|
| 4173 00 | 0.02 | 0.1 to 0.16 | 2.1 | 5120 | 1 |
| 4173 01 | 0.06 | 0.16 to 0.25 | 3.3 | 5120 | 1 |
| 4173 02 | 0.09 | 0.25 to 0.4 | 5.2 | 5120 | 1 |
| 4173 03 | 0.12 | 0.4 to 0.63 | 8.2 | 5960 | 1 |
| 4173 04 | 0.18 / 0.25 | 0.63 to 1 | 13 | 5960 | 1 |
| 4173 05 | 0.37 / 0.55 | 1 to 1.6 | 20.8 | 5990 | 1 |
| 4173 06 | 0.75 | 1.6 to 2.5 | 32.5 | 6110 | 1 |
| 4173 07 | 1.5 | 2.5 to 4 | 52 | 6210 | 1 |
| 4173 08 | 2.2 | 4 to 6 | 78 | 6240 | 1 |
| 4173 09 | 3 | 5 to 8 | 104 | 6240 | 1 |

415 V breaking capacity Icu (kA) - 50

| | | | | | |
|---------|-----|---------|-----|------|---|
| 4173 10 | 4 | 6 to 10 | 130 | 6240 | 1 |
| 4173 11 | 5.5 | 9 to 13 | 169 | 6300 | 1 |

415 V breaking capacity Icu (kA) - 20

| | | | | | |
|---------|-----|----------|-----|------|---|
| 4173 12 | 7.5 | 11 to 17 | 221 | 7410 | 1 |
|---------|-----|----------|-----|------|---|

415 V breaking capacity Icu (kA) - 15

| | | | | | |
|---------|-----|----------|-----|-------|---|
| 4173 13 | 7.5 | 14 to 22 | 286 | 7870 | 1 |
| 4173 14 | 11 | 18 to 26 | 338 | 8460 | 1 |
| 4173 15 | 15 | 22 to 32 | 416 | 14050 | 1 |

Bold Cat.Nos are products normally available with Legrand (India) Stockists. Cat.Nos that are not bold - delivery within 4 - 8 weeks from the date of order. **Bold packing quantity** is our mandatory packing. Orders to be placed by Legrand (India) Stockist in multiples of the same.

MPCBs MPX³

| Cat.Nos | Description | MRP* ₹ / Unit | Pack |
|---------|-------------|---------------------|------|
|---------|-------------|---------------------|------|

MPX³ 32H - 3P

High breaking capacity with rotary handle
415 V breaking capacity Icu (kA) - 100

| | | | | | |
|---------|-------------|--------------|------|------|---|
| 4173 20 | 0.02 | 0.1 to 0.16 | 2.1 | 6320 | 1 |
| 4173 21 | 0.06 | 0.16 to 0.25 | 3.3 | 6320 | 1 |
| 4173 22 | 0.09 | 0.25 to 0.4 | 5.2 | 6320 | 1 |
| 4173 23 | 0.12 | 0.4 to 0.63 | 8.2 | 6950 | 1 |
| 4173 24 | 0.18 / 0.25 | 0.63 to 1 | 13 | 6950 | 1 |
| 4173 25 | 0.37 / 0.55 | 1 to 1.6 | 20.8 | 6950 | 1 |
| 4173 26 | 0.75 | 1.6 to 2.5 | 32.5 | 6950 | 1 |
| 4173 27 | 1.5 | 2.5 to 4 | 52 | 7160 | 1 |
| 4173 28 | 2.2 | 4 to 6 | 78 | 7190 | 1 |
| 4173 29 | 3 | 5 to 8 | 104 | 7760 | 1 |
| 4173 30 | 4 | 6 to 10 | 130 | 7840 | 1 |
| 4173 31 | 5.5 | 9 to 13 | 169 | 8610 | 1 |

415 V breaking capacity Icu (kA) - 50

| | | | | | |
|---------|-----|----------|-----|-------|---|
| 4173 32 | 7.5 | 11 to 17 | 221 | 9220 | 1 |
| 4173 33 | 7.5 | 14 to 22 | 286 | 10790 | 1 |
| 4173 34 | 11 | 18 to 26 | 338 | 10880 | 1 |
| 4173 35 | 15 | 22 to 32 | 416 | 16900 | 1 |

MPX³ 63H - 3P

High breaking capacity with rotary handle
Fixing on rail or by screw
415 V breaking capacity Icu (kA) - 100

| | | | | | |
|---------|-----|---------|-----|-------|---|
| 4173 60 | 4 | 6 to 10 | 130 | 16400 | 1 |
| 4173 61 | 5.5 | 9 to 13 | 169 | 16400 | 1 |

415 V breaking capacity Icu (kA) - 50

| | | | | | |
|---------|------|----------|-----|-------|---|
| 4173 62 | 7.5 | 11 to 17 | 221 | 16400 | 1 |
| 4173 63 | 7.5 | 14 to 22 | 286 | 18590 | 1 |
| 4173 64 | 11 | 18 to 26 | 338 | 18590 | 1 |
| 4173 65 | 15 | 22 to 32 | 416 | 18590 | 1 |
| 4173 66 | 18.5 | 28 to 40 | 520 | 20770 | 1 |
| 4173 67 | 22 | 34 to 50 | 650 | 25510 | 1 |
| 4173 68 | 30 | 45 to 63 | 819 | 27220 | 1 |

MPX³ 100H - 3P

High breaking capacity with rotary handle
Fixing on rail or by screw
415 V breaking capacity Icu (kA) - 100

| | | | | | |
|---------|-----|----------|-----|-------|---|
| 4173 70 | 7.5 | 11 to 17 | 221 | 22670 | 1 |
| 4173 71 | 7.5 | 14 to 22 | 286 | 22670 | 1 |
| 4173 72 | 11 | 18 to 26 | 338 | 26940 | 1 |



4173 68



4173 79



4173 48



4174 00

MPCBs MPX³

| Cat.Nos | Description | MRP* ₹ / Unit | Pack |
|---------|-------------|---------------------|------|
|---------|-------------|---------------------|------|

Used to connect MPX³ directly with the contactor

| | | | | | |
|---------|------|----------|-----|-------|---|
| 4173 73 | 15 | 22 to 32 | 416 | 22670 | 1 |
| 4173 74 | 18.5 | 28 to 40 | 520 | 22670 | 1 |
| 4173 75 | 22 | 34 to 50 | 650 | 26940 | 1 |
| 4173 76 | 30 | 45 to 63 | 819 | 28250 | 1 |

415 V breaking capacity Icu (kA) - 75

| | | | | | |
|---------|----|-----------|------|-------|---|
| 4173 77 | 37 | 55 to 75 | 975 | 30360 | 1 |
| 4173 78 | 45 | 70 to 90 | 1170 | 30360 | 1 |
| 4173 79 | 45 | 80 to 100 | 1300 | 30360 | 1 |

Magnetic only MPCBs

Without thermal release
Magnetic release 13 x Ie max.

MPX³ 32MA - 3P

High breaking capacity with rotary handle
Fixing on rail
415 V breaking capacity Icu (kA) - 100

| | | | | |
|---------|-------------|------|------|---|
| 4173 40 | 0.02 | 2.1 | 5790 | 1 |
| 4173 41 | 0.06 | 3.3 | 5790 | 1 |
| 4173 42 | 0.09 | 5.2 | 5790 | 1 |
| 4173 43 | 0.12 | 8.2 | 6450 | 1 |
| 4173 44 | 0.18 / 0.25 | 13 | 6450 | 1 |
| 4173 45 | 0.37 / 0.55 | 20.8 | 6450 | 1 |
| 4173 46 | 0.75 | 32.5 | 6450 | 1 |
| 4173 47 | 1.5 | 52 | 6540 | 1 |
| 4173 48 | 2.2 | 78 | 6540 | 1 |
| 4173 49 | 3 | 104 | 6540 | 1 |
| 4173 50 | 4 | 130 | 6890 | 1 |
| 4173 51 | 5.5 | 169 | 7330 | 1 |

415 V breaking capacity Icu (kA) - 50

| | | | | |
|---------|-----|-----|-------|---|
| 4173 52 | 7.5 | 221 | 9430 | 1 |
| 4173 53 | 7.5 | 286 | 9430 | 1 |
| 4173 54 | 11 | 338 | 9430 | 1 |
| 4173 55 | 15 | 416 | 15590 | 1 |

MPCBs MPX³ Accessories

| Cat.Nos | Description | MRP* ₹ / Unit | Pack |
|---------|-------------|---------------------|------|
|---------|-------------|---------------------|------|

Auxiliary Contacts

2 pole

Side Mounting

Mounting on the left side of MPCBs
Two auxiliary contacts per MPCB

| | | | |
|---------|-------------|------|---|
| 4174 00 | 1 NO + 1 NC | 1240 | 5 |
| 4174 01 | 2 NO | 1240 | 5 |
| 4174 02 | 2 NC | 1240 | 5 |

Front mounting

One auxiliary contact per MPCB

| | | | |
|---------|-------------|------|---|
| 4174 03 | 1 NO + 1 NC | 1270 | 5 |
| 4174 04 | 2 NO | 1270 | 5 |
| 4174 05 | 2 NC | 1270 | 5 |

* MRP - Maximum Retail Price Inclusive of all taxes including GST.

Bold Cat.Nos are products normally available with Legrand (India) Stockists.
Cat.Nos that are not bold - delivery within 4 - 8 weeks from the date of order.
Bold packing quantity is our mandatory packing. Orders to be placed by Legrand (India) Stockist in multiples of the same.

MPCBs MPX³ Accessories

| Cat.Nos | Description | MRP* ₹ / Unit | Pack |
|---------|-------------|---------------------|------|
|---------|-------------|---------------------|------|

Alarm Contacts

1 NO + 1 NC

Any Trip Alarm Contact

Operates in case of trip

Mounting on the left side of MPCBs

Set alarm contact first in case of using auxiliary contact together (MPX³ 63H can not accept auxiliary contact and alarm contact together)

| | | | |
|---------|---------------------------------|------|---|
| 4174 06 | For MPX ³ 32 | 2010 | 1 |
| 4174 08 | For MPX ³ 63 and 100 | 2010 | 1 |

Magnetic Trip Alarm Contact

Operates in case of instantaneous trip

Mounting on the left side of MPCBs

Set alarm contact first in case of using auxiliary contact together

| | | | |
|---------|-------------|------|---|
| 4174 07 | 1 NO + 1 NC | 2010 | 1 |
|---------|-------------|------|---|

Shunt Release

Mounting On The Right Side Of MPCBs

One release per MPCB

| | | | |
|---------|--|------|---|
| 4174 10 | 24 V~ 50 Hz / 28 V~ 60 Hz | 3190 | 1 |
| 4174 11 | 110 V~ 50 Hz / 120 V~ 60 Hz | 3190 | 1 |
| 4174 12 | 220-230 V~ 50 Hz / 240-260 V~ 60 Hz | 3190 | 1 |
| 4174 13 | 380-400 V~ 50 Hz / 440-460 V~ 60 Hz | 3190 | 1 |



4174 12

Undervoltage Release

Mounting On The Right Side Of MPCBs

One release per MPCB

Without Auxiliary Contact

| | | | |
|---------|--|------|---|
| 4174 20 | 24 V~ 50 Hz / 28 V~ 60 Hz | 3190 | 1 |
| 4174 21 | 110 V~ 50 Hz / 120 V~ 60 Hz | 3190 | 1 |
| 4174 22 | 220-230 V~ 50 Hz / 240-260 V~ 60 Hz | 3190 | 1 |
| 4174 23 | 380-400 V~ 50 Hz / 440-460 V~ 60 Hz | 3190 | 1 |



4174 22

* MRP - Maximum Retail Price Inclusive of all taxes including GST.

MPCBs MPX³ Accessories

| Cat.Nos | Description | MRP* ₹ / Unit | Pack |
|---------|-------------|---------------------|------|
|---------|-------------|---------------------|------|

With 2 NO Auxiliary Contacts

Can not attach to MPX³ 32S

| | | | |
|---------|--|------|---|
| 4174 30 | 24 V~ 50 Hz / 28 V~ 60 Hz | 4250 | 1 |
| 4174 31 | 110 V~ 50 Hz / 120 V~ 60 Hz | 4250 | 1 |
| 4174 32 | 220-230 V~ 50 Hz / 240-260 V~ 60 Hz | 4250 | 1 |
| 4174 33 | 380-400 V~ 50 Hz / 440-460 V~ 60 Hz | 4250 | 1 |

Dial Cover

Sealable cover to protect the set value from the operation that is not intended

Without Auxiliary Contact

| | | | |
|---------|-----------------------------------|-----|----|
| 4174 79 | For all types of MPX ³ | 140 | 50 |
|---------|-----------------------------------|-----|----|

Direct Adaptor and Mounting unit

For mounting CTX³ contactors under MPX³ MPCBs

Direct Adaptors

Used to connect MPX³ directly with the contactor

| | | | |
|---------|--|-----|---|
| 4174 40 | For MPX ³ 32S with CTX ³ mini AC | 740 | 2 |
| 4174 41 | For MPX ³ 32S with CTX ³ mini DC | 740 | 2 |
| 4174 42 | For MPX ³ 32H/32MA with CTX ³ mini AC | 740 | 2 |
| 4174 43 | For MPX ³ 32H/32MA with CTX ³ mini DC | 740 | 2 |
| 4174 48 | For MPX ³ 32S with CTX ³ 22 AC | 890 | 2 |
| 4174 49 | For MPX ³ 32S with CTX ³ 22 DC | 890 | 2 |
| 4174 50 | For MPX ³ 32H/32MA with CTX ³ 22 AC | 890 | 2 |

Bold Cat.Nos are products normally available with Legrand (India) Stockists. Cat.Nos that are not bold - delivery within 4 - 8 weeks from the date of order. **Bold packing quantity** is our mandatory packing. Orders to be placed by Legrand (India) Stockist in multiples of the same.

MPCBs MPX³ Accessories

| Cat.Nos | Description | MRP* ₹ / Unit | Pack |
|--|---|---------------------|------|
| Direct Adaptators | | | |
| Used To Connect MPX ³ Directly with the Contactor | | | |
| 4174 51 | For MPX ³ 32H/32MA with CTX ³ 22 DC | 890 | 2 |
| 4174 52 | For MPX ³ 32S with CTX ³ 40 AC | 1090 | 2 |
| 4174 53 | For MPX ³ 32S with CTX ³ 40 DC | 1090 | 2 |
| 4174 54 | For MPX ³ 32H/32MA with CTX ³ 40 AC | 1090 | 2 |
| 4174 55 | For MPX ³ 32H/32MA with CTX ³ 40 DC | 1090 | 2 |
| 4174 56 | For MPX ³ 63H with CTX ³ 65 AC with cage type terminals | 1300 | 2 |
| 4174 57 | For MPX ³ 63H with CTX ³ 65 DC with cage type terminals | 1300 | 2 |
| 4174 58 | For MPX ³ 100H with CTX ³ 100 AC with cage type terminals | 1300 | 1 |
| 4174 59 | For MPX ³ 100H with CTX ³ 100 DC with cage type terminals | 1300 | 1 |

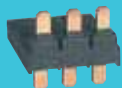

4174 56



4174 61

Mounting Unit

This device is used for joining together MPX³ MCPBs and CTX³ contactors

| | | | |
|---------|-----------------------------------|------|---|
| 4174 60 | For MPX ³ 32S/32H/32MA | 1010 | 2 |
| 4174 61 | For MPX ³ 63H | 1850 | 1 |
| 4174 62 | For MPX ³ 100H | 2230 | 1 |

MPCBs MPX³ Accessories

| Cat.Nos | Description | MRP* ₹ / Unit | Pack |
|--|------------------------------------|---------------------|------|
| Rotary Handle | | | |
| Mounting On Panel's Door To Control The MPX ³ | | | |
| 4174 63 | For MPX ³ 32H and 32 MA | 2630 | 1 |
| 4174 64 | For MPX ³ 63H | 2630 | 1 |
| 4174 65 | For MPX ³ 100H | 3330 | 1 |



4174 63

Phase Busbar

For Parallel Connection of MPX³

For MPX³ 32S, 32H and 32MA

Rated Current 63 A

| | | | |
|---------|------------------------------|------|---|
| 4174 71 | 2 devices | 1040 | 5 |
| 4174 73 | 3 devices | 2600 | 5 |
| 4174 75 | 4 devices | 2600 | 5 |
| 4174 76 | 5 devices | 2600 | 5 |
| 4174 77 | Feeder for phase busbar 32 A | 720 | 5 |



4174 73

For MPX³ 63H

Rated Current 108 A

| | | | |
|---------|-----------|------|---|
| 4174 72 | 2 devices | 1850 | 5 |
| 4174 74 | 3 devices | 2780 | 5 |

Enclosures for MPX³ 32H and 32MA

IP 65 enclosure to use in dusty areas as well as in presence of corrosive gas or liquid

| | | | |
|---------|-------------------------------|------|---|
| 4174 80 | Yellow/red with rotary handle | 2150 | 5 |
| 4174 81 | With black rotary handle | 2780 | 5 |



4174 81

* MRP - Maximum Retail Price Inclusive of all taxes including GST.

Bold Cat.Nos are products normally available with Legrand (India) Stockists. **Cat.Nos that are not bold** - delivery within 4 - 8 weeks from the date of order. **Bold packing quantity** is our mandatory packing. Orders to be placed by Legrand (India) Stockist in multiples of the same.

Alpx³

Capacitors

Reliable and Efficient Power Factor Correction with Alpx³



Alpx³ is a premium range of power capacitors designed for reliable reactive power compensation in modern electrical installations. With robust construction, compact design, and high-quality components, they ensure efficient performance and long service life even in networks with demanding harmonic conditions.

Features

- Self-healing capacitor technology
- Suitable for networks with harmonic distortion
- Compact design for easy panel integration
- Low-loss construction for improved efficiency

Benefits

- Reduces electricity costs by improving power factor
- Increases system capacity by freeing transformer and cable kVA
- Improves voltage stability for better equipment performance
- Enhances overall system efficiency and reliability



Scan to know more about the product.



Alpx³ Resin Filled Capacitors

| Cat.Nos | Description | MRP* ₹ / Unit | Pack |
|---------|-------------|---------------------|------|
|---------|-------------|---------------------|------|

Confirms to IS13340-1&2 , IEC60831-1&2
ISI Mark
Compact Design
Self healing metallized polypropylene film
Over pressure device for disconnection
Low energy losses
Resistance to high temperature
Resin filled

Can be used in system with <= 10% THDi

Standard Duty Can-Type 440 V

| | | | |
|---------|--------------------------------|-------|---|
| 5150 00 | 1 kVAr Resin std duty 440 V | 410 | 1 |
| 5150 01 | 2 kVAr Resin std duty 440 V | 860 | 1 |
| 5150 02 | 3 kVAr Resin std duty 440 V | 1230 | 1 |
| 5150 03 | 4 kVAr Resin std duty 440 V | 1720 | 1 |
| 5150 04 | 5 kVAr Resin std duty 440 V | 2010 | 1 |
| 5150 05 | 7.5 kVAr Resin std duty 440 V | 2960 | 1 |
| 5150 06 | 10 kVAr Resin std duty 440 V | 3950 | 1 |
| 5150 07 | 12.5 kVAr Resin std duty 440 V | 4940 | 1 |
| 5150 08 | 15 kVAr Resin std duty 440 V | 5920 | 1 |
| 5150 09 | 20 kVAr Resin std duty 440 V | 7750 | 1 |
| 5150 10 | 25 kVAr Resin std duty 440 V | 9780 | 1 |
| 5150 11 | 30 kVAr Resin std duty 440 V | 11790 | 1 |



5150 04



5150 06

Standard Duty Can-Type 480 V

| | | | |
|---------|-----------------------|-------|---|
| 5150 24 | 4.2 kVAr Resin 480 V | 3030 | 1 |
| 5150 25 | 6.9 kVAr Resin 480 V | 4880 | 1 |
| 5150 26 | 8.7 kVAr Resin 480 V | 6180 | 1 |
| 5150 27 | 10.4 kVAr Resin 480 V | 7430 | 1 |
| 5150 28 | 14 kVAr Resin 480 V | 9900 | 1 |
| 5150 29 | 17.4 kVAr Resin 480 V | 11720 | 1 |
| 5150 30 | 20.8 kVAr Resin 480 V | 13930 | 1 |

Alpx³ Resin Filled Capacitors

| Cat.Nos | Description | MRP* ₹ / Unit | Pack |
|---------|-------------|---------------------|------|
|---------|-------------|---------------------|------|

Standard Duty Can-Type 525 V

| | | | |
|---------|-----------------------|-------|---|
| 5150 31 | 5 kVAr Resin 525 V | 3600 | 1 |
| 5150 32 | 8.3 kVAr Resin 525 V | 6180 | 1 |
| 5150 33 | 10.4 kVAr Resin 525 V | 7440 | 1 |
| 5150 34 | 12.5 kVAr Resin 525 V | 9140 | 1 |
| 5150 35 | 16.7 kVAr Resin 525 V | 11540 | 1 |
| 5150 36 | 20.8 kVAr Resin 525 V | 14760 | 1 |
| 5150 37 | 25 kVAr Resin 525 V | 17280 | 1 |

Standard Duty Box-Type 440 V

| | | | |
|---------|-----------------------------------|-------|---|
| 5150 40 | 1 kVAr Std box Capacitor 440 V | 550 | 1 |
| 5150 41 | 2 kVAr Std box Capacitor 440 V | 1100 | 1 |
| 5150 42 | 3 kVAr Std box Capacitor 440 V | 1660 | 1 |
| 5150 43 | 4 kVAr Std box Capacitor 440 V | 2210 | 1 |
| 5150 44 | 5 kVAr Std box Capacitor 440 V | 2720 | 1 |
| 5150 45 | 7.5 kVAr Std box Capacitor 440 V | 4010 | 1 |
| 5150 46 | 8.33 kVAr Std box Capacitor 440 V | 4520 | 1 |
| 5150 47 | 10 kVAr Std box Capacitor 440 V | 5350 | 1 |
| 5150 48 | 12.5 kVAr Std box Capacitor 440 V | 6690 | 1 |
| 5150 49 | 15 kVAr Std box Capacitor 440 V | 8020 | 1 |
| 5150 50 | 20 kVAr Std box Capacitor 440 V | 10500 | 1 |
| 5150 51 | 25 kVAr Std box Capacitor 440 V | 13120 | 1 |
| 5150 52 | 50 kVAr Std box Capacitor 440 V | 27250 | 1 |



5150 47

* MRP - Maximum Retail Price Inclusive of all taxes including GST.

Bold Cat.Nos are products normally available with Legrand (India) Stockists. **Cat.Nos that are not bold** - delivery within 4 - 8 weeks from the date of order. **Bold packing quantity** is our mandatory packing. Orders to be placed by Legrand (India) Stockist in multiples of the same.

Reactors

| Cat.Nos | Description | MRP* ₹ / Unit | Pack |
|---------|-------------|------------------|------|
|---------|-------------|------------------|------|

Can be used in system with <= 15% THDi

Heavy Duty Can-Type 440 V

| | | | |
|---------|-------------------------------|-------|---|
| 5150 12 | 1 kVAr Resin heavy duty 440 V | 780 | 1 |
| 5150 13 | 2 kVAr Resin heavy duty 440 V | 1630 | 1 |
| 5150 14 | 3 kVAr Resin heavy duty 440 V | 2340 | 1 |
| 5150 15 | 4 kVAr Resin heavy duty 440 V | 3250 | 1 |
| 5150 16 | 5 kVAr Resin heavy duty 440 V | 3510 | 1 |
| 5150 17 | 7.5 kVAr Resin heavy duty 440 | 5270 | 1 |
| 5150 18 | 10 kVAr Resin heavy duty 440 | 6890 | 1 |
| 5150 19 | 12.5 kVAr Resin heavy duty 44 | 8620 | 1 |
| 5150 20 | 15 kVAr Resin heavy duty 440 | 10350 | 1 |
| 5150 21 | 20 kVAr Resin heavy duty 440 | 13280 | 1 |
| 5150 22 | 25 kVAr Resin heavy duty 440 | 16600 | 1 |
| 5150 23 | 30 kVAr Resin heavy duty 440 | 20010 | 1 |



5150 23

Reactors

| Cat.Nos | Description | MRP* ₹ / Unit | Pack |
|---------|-------------|------------------|------|
|---------|-------------|------------------|------|

Heavy Duty Box-Type 440 V

| | | | |
|---------|------------------------|-------|---|
| 5150 53 | 5 kVAr HD box 440 V | 4300 | 1 |
| 5150 54 | 7.5 kVAr HD box 440 V | 6280 | 1 |
| 5150 55 | 8.33 kVAr HD box 440 V | 6950 | 1 |
| 5150 56 | 10 kVAr HD box 440 V | 8370 | 1 |
| 5150 57 | 12.5 kVAr HD box 440 V | 10470 | 1 |
| 5150 58 | 15 kVAr HD box 440 V | 12560 | 1 |
| 5150 59 | 20 kVAr HD box 440 V | 15940 | 1 |
| 5150 60 | 25 kVAr HD box 440 V | 19930 | 1 |
| 5150 61 | 50 kVAr HD box 440 V | 39850 | 1 |



5150 61



4151 50

Reactors 7 % Duty

| | | | |
|---------|-------------------|--------|---|
| 4151 48 | Reactor 10 kVAr | 22350 | 1 |
| 4151 49 | Reactor 12.5 kVAr | 29270 | 1 |
| 4151 50 | Reactor 25 kVAr | 37260 | 1 |
| 4151 51 | Reactor 50 kVAr | 60610 | 1 |
| 4151 52 | Reactor 100 kVAr | 121400 | 1 |

Reactors 14 % Duty

| | | | |
|---------|-------------------|-------|---|
| 4151 53 | Reactor 12.5 kVAr | 39500 | 1 |
| 4151 54 | Reactor 25 kVAr | 65830 | 1 |
| 4151 55 | Reactor 50 kVAr | 87040 | 1 |

Power Factor Controller Eco

| | | | |
|---------|--------------------|-------|---|
| 4151 95 | 4 step controller | 26310 | 1 |
| 4151 96 | 6 step controller | 23860 | 1 |
| 4151 97 | 8 step controller | 26760 | 1 |
| 4151 98 | 12 step controller | 31820 | 1 |

* MRP - Maximum Retail Price Inclusive of all taxes including GST.

Warranty

- The Company, at its discretion, will replace products if they have any manufacturing defect within 1 years for capacitor, Reactor & APFC controller.
- The above guarantee is applicable when the products are selected taken into consideration all the technical characteristics of the product published in our catalogue.
- The guarantee is only applicable when the products are installed as per the Company's instructions and not tampered in any manner.
- The guarantee states the Company's entire liability. It does not extend to cover consequential loss or damage or installation costs arising from defective products.

Alpx³ range of capacitor - Selection Chart

DETERMINING THE CAPACITOR BANK TYPE ACCORDING TO THE LEVEL OF HARMONICS

For supplies with a high level of harmonic pollution, Legrand recommends capacitor banks with detuned reactors.

The detuned reactor performs a threefold role:



- Increasing the capacitor impedance in relation to the harmonic currents
- Shifting the parallel resonance frequency (Fr.p) of the source and capacitor to below the main frequencies of the harmonic currents that are causing interference.

| Tuning frequency (Hz) | Blocking factor (P%) | Tuning number (n) |
|-----------------------|----------------------|-------------------|
| 189 | 7 | 3.78 |
| 135 | 14 | 2.7 |

- Helping to reduce harmonic levels in the supply.

The table opposite can be used to select the capacitor bank type according to the degree of harmonic pollution, by measuring the percentage of THDi and THDu or by estimating the percentage total power of SH/ST non-linear loads.

| Measurements | | Estimates | Type of capacitor to be used | Reactor to be used |
|--------------|--------|-----------|------------------------------|---|
| THDU % | THDi % | SH/ST % | | |
| ≤ 3 | ≤ 10 | ≤ 15 | Standard Duty | - |
| ≤ 4 | ≤ 15 | ≤ 25 | Heavy Duty | - |
| ≤ 6 | ≤ 30 | ≤ 35 | Standard Duty | 7% Reactor *14% Reactor if high level of 3rd order harmonics |
| ≤ 8 | ≤ 40 | ≤ 50 | Heavy Duty | 7% Reactor |

SH (kVA) is the weighted total power of the harmonic generators present at the transformer secondary.

ST (kVA) is the power rating of the HV/LV transformer.

THDi = Total Harmonic Distortion (THD) is the ratio of the rms value of the harmonic currents In of the order n to the rms value of the fundamental.

THDu = Voltage Distortion (THDu) is caused mainly by the high level of Current Distortion (THDi) and the level of THDu is dependent on the source impedance.

* for example if -

- Ih5 > 0.2x145
- Ih3 : 3rd order harmonic currents
- Ih5 : 5th order harmonic currents

Note: These statements are based on our knowledge of typical application. We clearly point out that these statements cannot be regarded as binding statements about the suitability of our products for a particular customer application. It is necessary that the customer should check and decide whether the product is suitable for use in a particular application.

DX³

Modular Protection Devices

Complete Protection for Residential, Commercial & Industrial Applications



DX³ protective devices deliver a comprehensive circuit protection solution built for modern electrical systems. Designed to support efficient panel building and consistent performance, they provide a dependable foundation for safe and streamlined electrical distribution across diverse applications.

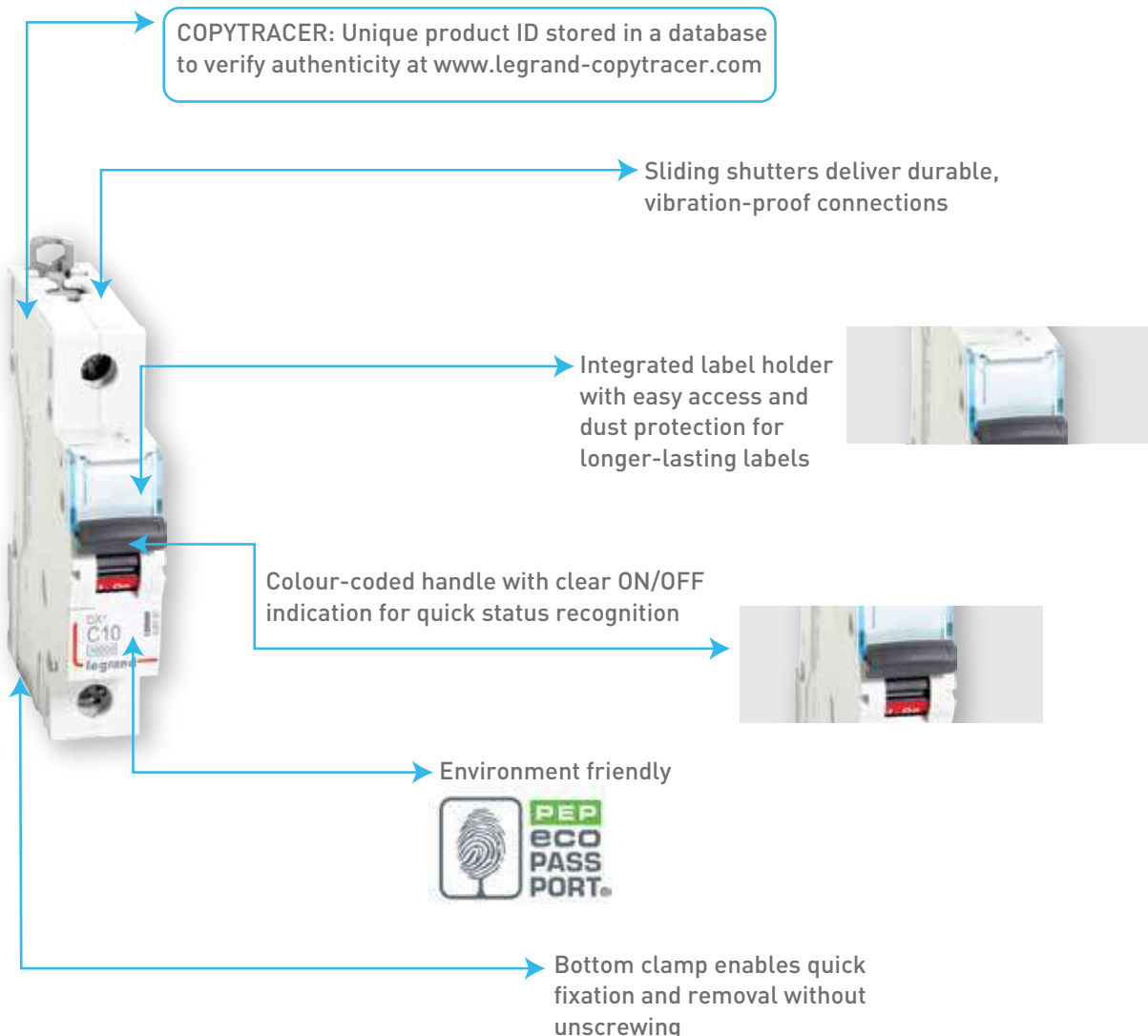

Range

The DX³ range has a selection of electrical auxiliaries for monitoring and controlling circuits remotely

Auxiliary contacts and fault signal contacts, shunt trips, undervoltage releases, motorised controls and automatic reclosers.

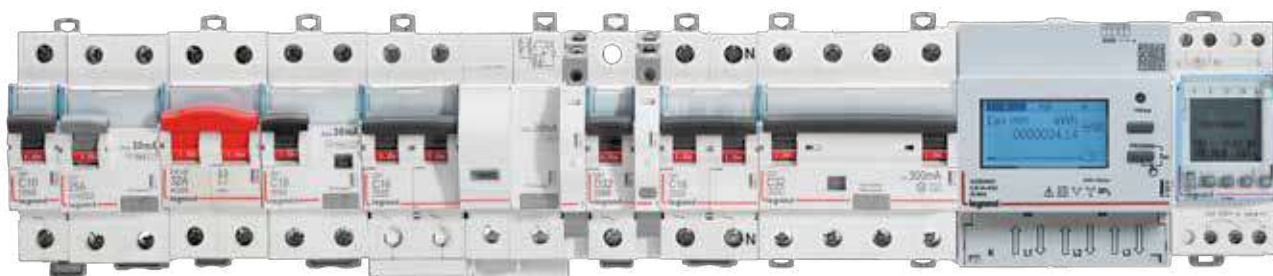

Scan to know more about the product.



DX³ AC MCBs

| Cat.Nos | Nominal Rating | Number of 17.5 mm modules | MRP* ₹ / Unit | Pack |
|---------|----------------|---------------------------|---------------|------|
|---------|----------------|---------------------------|---------------|------|

MCBs for AC Applications till 63A

10 kA ISI marked as per IS/IEC 60898-1 2002
 Integrated label holder
 Sliding bottom clamp
 Efficient air channels
 Color coded On/Off indication on dolly
 Biconnect lower terminals
 IP 20 protected terminals
 Sliding shutters
 Compatible with signal and control Auxiliaries

DC-80 V per pole - 1 kA

C Curve

Single Pole 240/410V

| | | | | |
|---------|-----|---|------|----------|
| 4085 80 | 0.5 | 1 | 736 | 1/10/120 |
| 4085 81 | 1 | 1 | 736 | 1/10/120 |
| 4085 83 | 2 | 1 | 729 | 1/10/120 |
| 4085 84 | 3 | 1 | 729 | 1/10/120 |
| 4085 85 | 4 | 1 | 729 | 1/10/120 |
| 4085 87 | 6 | 1 | 449 | 1/10/120 |
| 4085 90 | 10 | 1 | 449 | 1/10/120 |
| 4085 92 | 16 | 1 | 449 | 1/10/120 |
| 4085 93 | 20 | 1 | 449 | 1/10/120 |
| 4085 94 | 25 | 1 | 449 | 1/10/120 |
| 4085 95 | 32 | 1 | 449 | 1/10/120 |
| 4085 96 | 40 | 1 | 1026 | 1/10/120 |
| 4085 97 | 50 | 1 | 1026 | 1/10/120 |
| 4085 98 | 63 | 1 | 1026 | 1/10/120 |



4085 90

Single Pole + Neutral 240V

| | | | | |
|---------|-----|---|------|--------|
| 4086 02 | 0.5 | 2 | 1925 | 1/5/60 |
| 4086 03 | 1 | 2 | 1925 | 1/5/60 |
| 4086 05 | 2 | 2 | 1925 | 1/5/60 |
| 4086 06 | 3 | 2 | 1925 | 1/5/60 |
| 4086 07 | 4 | 2 | 1925 | 1/5/60 |
| 4086 09 | 6 | 2 | 1362 | 1/5/60 |
| 4086 12 | 10 | 2 | 1362 | 1/5/60 |
| 4086 14 | 16 | 2 | 1362 | 1/5/60 |
| 4086 15 | 20 | 2 | 1362 | 1/5/60 |
| 4086 16 | 25 | 2 | 1362 | 1/5/60 |
| 4086 17 | 32 | 2 | 1362 | 1/5/60 |
| 4086 18 | 40 | 2 | 2203 | 1/5/60 |
| 4086 19 | 50 | 2 | 2203 | 1/5/60 |
| 4086 20 | 63 | 2 | 2203 | 1/5/60 |



4086 14

* MRP - Maximum Retail Price Inclusive of all taxes including GST.

DX³ AC MCBs

| Cat.Nos | Nominal Rating | Number of 17.5 mm modules | MRP* ₹ / Unit | Pack |
|---------|----------------|---------------------------|---------------|------|
|---------|----------------|---------------------------|---------------|------|

Double Pole 415V

| | | | | |
|---------|-----|---|------|------|
| 4086 21 | 0.5 | 2 | 1999 | 1/40 |
| 4086 22 | 1 | 2 | 1999 | 1/40 |
| 4086 24 | 2 | 2 | 1999 | 1/40 |
| 4086 25 | 3 | 2 | 1999 | 1/40 |
| 4086 26 | 4 | 2 | 1999 | 1/40 |
| 4086 28 | 6 | 2 | 1472 | 1/40 |
| 4086 31 | 10 | 2 | 1472 | 1/40 |
| 4086 33 | 16 | 2 | 1472 | 1/40 |
| 4086 34 | 20 | 2 | 1472 | 1/40 |
| 4086 35 | 25 | 2 | 1472 | 1/40 |
| 4086 36 | 32 | 2 | 1472 | 1/40 |
| 4086 37 | 40 | 2 | 2316 | 1/40 |
| 4086 38 | 50 | 2 | 2316 | 1/40 |
| 4086 39 | 63 | 2 | 2316 | 1/40 |



4086 37

Triple Pole 415V

| | | | | |
|---------|-----|---|------|------|
| 4086 43 | 0.5 | 3 | 2944 | 1/32 |
| 4086 44 | 1 | 3 | 2944 | 1/32 |
| 4086 46 | 2 | 3 | 2944 | 1/32 |
| 4086 47 | 3 | 3 | 2944 | 1/32 |
| 4086 48 | 4 | 3 | 2944 | 1/32 |
| 4086 50 | 6 | 3 | 2387 | 1/32 |
| 4086 53 | 10 | 3 | 2387 | 1/32 |
| 4086 55 | 16 | 3 | 2387 | 1/32 |
| 4086 56 | 20 | 3 | 2387 | 1/32 |
| 4086 57 | 25 | 3 | 2387 | 1/32 |
| 4086 58 | 32 | 3 | 2387 | 1/32 |
| 4086 59 | 40 | 3 | 3623 | 1/32 |
| 4086 60 | 50 | 3 | 3623 | 1/32 |
| 4086 61 | 63 | 3 | 3623 | 1/32 |



4086 55

Triple Pole + Neutral 415V

| | | | | |
|---------|-----|---|------|------|
| 4086 65 | 0.5 | 4 | 3735 | 1/32 |
| 4086 66 | 1 | 4 | 3735 | 1/32 |
| 4086 68 | 2 | 4 | 3735 | 1/32 |
| 4086 69 | 3 | 4 | 3735 | 1/32 |
| 4086 70 | 4 | 4 | 3735 | 1/32 |
| 4086 72 | 6 | 4 | 3112 | 1/32 |
| 4086 75 | 10 | 4 | 3112 | 1/32 |
| 4086 77 | 16 | 4 | 3112 | 1/32 |
| 4086 78 | 20 | 4 | 3112 | 1/32 |
| 4086 79 | 25 | 4 | 3112 | 1/32 |
| 4086 80 | 32 | 4 | 3112 | 1/32 |
| 4086 81 | 40 | 4 | 4451 | 1/32 |
| 4086 82 | 50 | 4 | 4451 | 1/32 |
| 4086 83 | 63 | 4 | 4451 | 1/32 |



4086 77

Bold Cat.Nos are products normally available with Legrand (India) Stockists. Cat.Nos that are not bold - delivery within 4 - 8 weeks from the date of order. Bold packing quantity is our mandatory packing. Orders to be placed by Legrand (India) Stockist in multiples of the same.

DX³ AC MCBs

| Cat.Nos | Nominal Rating | Number of 17.5 mm modules | MRP* ₹ / Unit | Pack |
|---------|----------------|---------------------------|---------------|------|
|---------|----------------|---------------------------|---------------|------|

Four Pole 415V

| | | | | |
|---------|-----|---|------|------|
| 4086 84 | 0.5 | 4 | 3687 | 1/32 |
| 4086 85 | 1 | 4 | 3687 | 1/32 |
| 4086 87 | 2 | 4 | 3687 | 1/32 |
| 4086 88 | 3 | 4 | 3687 | 1/32 |
| 4086 89 | 4 | 4 | 3687 | 1/32 |
| 4086 91 | 6 | 4 | 3243 | 1/32 |
| 4086 94 | 10 | 4 | 3243 | 1/32 |
| 4086 96 | 16 | 4 | 3243 | 1/32 |
| 4086 97 | 20 | 4 | 3243 | 1/32 |
| 4086 98 | 25 | 4 | 3243 | 1/32 |
| 4086 99 | 32 | 4 | 3243 | 1/32 |
| 4087 00 | 40 | 4 | 4614 | 1/32 |
| 4087 01 | 50 | 4 | 4614 | 1/32 |
| 4087 02 | 63 | 4 | 4614 | 1/32 |



4086 94

D Curve

Single Pole 240/415V

| | | | | |
|---------|-----|---|-----|----------|
| 4087 06 | 0.5 | 1 | 741 | 1/10/120 |
| 4087 07 | 1 | 1 | 741 | 1/10/120 |
| 4087 09 | 2 | 1 | 741 | 1/10/120 |
| 4087 10 | 3 | 1 | 741 | 1/10/120 |
| 4087 11 | 4 | 1 | 741 | 1/10/120 |
| 4087 12 | 6 | 1 | 616 | 1/10/120 |
| 4087 14 | 10 | 1 | 616 | 1/10/120 |
| 4087 16 | 16 | 1 | 616 | 1/10/120 |
| 4087 17 | 20 | 1 | 616 | 1/10/120 |
| 4087 18 | 25 | 1 | 616 | 1/10/120 |
| 4087 19 | 32 | 1 | 616 | 1/10/120 |
| 4087 20 | 40 | 1 | ■ | 1/10/120 |
| 4087 21 | 50 | 1 | ■ | 1/10/120 |
| 4087 22 | 63 | 1 | ■ | 1/10/120 |



4087 19

Single Pole + Neutral 240V

| | | | | |
|---------|-----|---|------|--------|
| 4087 26 | 0.5 | 2 | 1925 | 1/5/60 |
| 4087 27 | 1 | 2 | 1925 | 1/5/60 |
| 4087 29 | 2 | 2 | 1925 | 1/5/60 |
| 4087 30 | 3 | 2 | 1925 | 1/5/60 |
| 4087 31 | 4 | 2 | 1925 | 1/5/60 |

Double Pole 415V

| | | | | |
|---------|-----|---|------|------|
| 4087 32 | 0.5 | 2 | 2017 | 1/40 |
| 4087 33 | 1 | 2 | 2017 | 1/40 |
| 4087 35 | 2 | 2 | 2017 | 1/40 |
| 4087 36 | 3 | 2 | 2017 | 1/40 |
| 4087 37 | 4 | 2 | 2017 | 1/40 |
| 4087 38 | 6 | 2 | 1525 | 1/40 |
| 4087 40 | 10 | 2 | 1525 | 1/40 |
| 4087 42 | 16 | 2 | 1525 | 1/40 |
| 4087 43 | 20 | 2 | 1525 | 1/40 |
| 4087 44 | 25 | 2 | 1525 | 1/40 |
| 4087 45 | 32 | 2 | 1525 | 1/40 |
| 4087 46 | 40 | 2 | ■ | 1/40 |
| 4087 47 | 50 | 2 | ■ | 1/40 |
| 4087 48 | 63 | 2 | ■ | 1/40 |



4087 46

D Curve

| Cat.Nos | Nominal Rating | Number of 17.5 mm modules | MRP* ₹ / Unit | Pack |
|---------|----------------|---------------------------|---------------|------|
|---------|----------------|---------------------------|---------------|------|

Triple Pole 415V

| | | | | |
|---------|-----|---|------|------|
| 4087 52 | 0.5 | 3 | 3004 | 1/32 |
| 4087 53 | 1 | 3 | 3004 | 1/32 |
| 4087 55 | 2 | 3 | 3004 | 1/32 |
| 4087 56 | 3 | 3 | 3004 | 1/32 |
| 4087 57 | 4 | 3 | 3004 | 1/32 |
| 4087 58 | 6 | 3 | 2461 | 1/32 |
| 4087 60 | 10 | 3 | 2461 | 1/32 |
| 4087 62 | 16 | 3 | 2461 | 1/32 |
| 4087 63 | 20 | 3 | 2461 | 1/32 |
| 4087 64 | 25 | 3 | 2461 | 1/32 |
| 4087 65 | 32 | 3 | 2461 | 1/32 |
| 4087 66 | 40 | 3 | ■ | 1/32 |
| 4087 67 | 50 | 3 | ■ | 1/32 |
| 4087 68 | 63 | 3 | ■ | 1/32 |



4087 52

Triple Pole + Neutral 415V

| | | | | |
|---------|-----|---|------|------|
| 4087 72 | 0.5 | 4 | 3662 | 1/32 |
| 4087 73 | 1 | 4 | 3662 | 1/32 |
| 4087 75 | 2 | 4 | 3662 | 1/32 |
| 4087 76 | 3 | 4 | 3662 | 1/32 |
| 4087 77 | 4 | 4 | 3662 | 1/32 |

Four Pole 415V

| | | | | |
|---------|-----|---|------|------|
| 4087 78 | 0.5 | 4 | 3652 | 1/32 |
| 4087 79 | 1 | 4 | 3652 | 1/32 |
| 4087 81 | 2 | 4 | 3652 | 1/32 |
| 4087 82 | 3 | 4 | 3652 | 1/32 |
| 4087 83 | 4 | 4 | 3652 | 1/32 |
| 4087 84 | 6 | 4 | 3220 | 1/32 |
| 4087 86 | 10 | 4 | 3220 | 1/32 |
| 4087 88 | 16 | 4 | 3220 | 1/32 |
| 4087 89 | 20 | 4 | 3220 | 1/32 |
| 4087 90 | 25 | 4 | 3220 | 1/32 |
| 4087 91 | 32 | 4 | 3220 | 1/32 |
| 4087 92 | 40 | 4 | ■ | 1/32 |
| 4087 93 | 50 | 4 | ■ | 1/32 |
| 4087 94 | 63 | 4 | ■ | 1/32 |



4087 90

Circuit Breakers AC Applications 80 - 125A

10 kA as per IEC 60947-2
 Integrated label holder
 Sliding insulating shield
 Color coded contact indication window
 IP 20 protected terminals
 50 sq mm terminals

Single Pole 230V / 400V

| | | | | |
|---------|-----|-----|------|---------|
| 4085 99 | 80 | 1.5 | 3977 | 1/5/160 |
| 4086 00 | 100 | 1.5 | 4352 | 1/5/161 |
| 4086 01 | 125 | 1.5 | 4722 | 1/5/162 |



4086 00

* MRP - Maximum Retail Price Inclusive of all taxes including GST.
 ■ Price available on request.

Bold Cat.Nos are products normally available with Legrand (India) Stockists.
 Cat.Nos that are not bold - delivery within 4 - 8 weeks from the date of order.
 Bold packing quantity is our mandatory packing. Orders to be placed by Legrand (India) Stockist in multiples of the same.

DX³ MCBs



4086 40



4086 63



4087 05

| Cat.Nos | Nominal Rating | Number of 17.5 mm modules | MRP* ₹ / Unit | Pack |
|---------|----------------|---------------------------|---------------|------|
|---------|----------------|---------------------------|---------------|------|

Double Pole 230V / 400V*

| | | | | |
|---------|-----|---|-------|--------|
| 4086 40 | 80 | 3 | 8814 | 1/5/60 |
| 4086 41 | 100 | 3 | 9393 | 1/5/60 |
| 4086 42 | 125 | 3 | 10228 | 1/5/60 |

Triple Pole 400V*

| | | | | |
|---------|-----|-----|-------|-----|
| 4086 62 | 80 | 4.5 | 14163 | 1/9 |
| 4086 63 | 100 | 4.5 | 15086 | 1/9 |
| 4086 64 | 125 | 4.5 | 16581 | 1/9 |

Four Pole 400V*

| | | | | |
|---------|-----|---|-------|-----|
| 4087 03 | 80 | 6 | 18264 | 1/9 |
| 4087 04 | 100 | 6 | 19030 | 1/9 |
| 4087 05 | 125 | 6 | 21319 | 1/9 |

DX³ DC MCBs

Circuit breakers DC applications upto 63A

6 kA as per IEC 60947-2
 Integrated label holder
 Sliding bottom clamp
 Improved air channels
 Color coded On/Off indication on dolly
 Biconnect lower terminals
 IP 20 protected terminals
 Sliding shutters

Single Pole 250V

| | | | | |
|---------|-----|---|------|----------|
| 4087 98 | 0.5 | 1 | 1095 | 1/10/120 |
| 4087 99 | 1 | 1 | 1095 | 1/10/120 |
| 4088 01 | 2 | 1 | 1095 | 1/10/120 |
| 4088 02 | 3 | 1 | 1095 | 1/10/120 |
| 4088 03 | 4 | 1 | 1095 | 1/10/120 |
| 4088 04 | 6 | 1 | 906 | 1/10/120 |
| 4088 06 | 10 | 1 | 906 | 1/10/120 |
| 4088 08 | 16 | 1 | 906 | 1/10/120 |
| 4088 09 | 20 | 1 | 906 | 1/10/120 |
| 4088 10 | 25 | 1 | 906 | 1/10/120 |
| 4088 11 | 32 | 1 | 915 | 1/10/120 |
| 4088 12 | 40 | 1 | 1210 | 1/10/120 |
| 4088 13 | 50 | 1 | 1210 | 1/10/120 |
| 4088 14 | 63 | 1 | 1210 | 1/10/120 |



4088 12

Double Pole 250V

| | | | | |
|---------|-----|---|------|--------|
| 4088 15 | 0.5 | 1 | 2284 | 1/5/60 |
| 4088 16 | 1 | 1 | 2284 | 1/5/60 |
| 4088 18 | 2 | 1 | 2284 | 1/5/60 |
| 4088 19 | 3 | 1 | 2284 | 1/5/60 |
| 4088 20 | 4 | 1 | 2284 | 1/5/60 |
| 4088 21 | 6 | 1 | 2118 | 1/5/60 |
| 4088 23 | 10 | 1 | 2118 | 1/5/60 |
| 4088 25 | 16 | 1 | 2118 | 1/5/60 |
| 4088 26 | 20 | 1 | 2118 | 1/5/60 |
| 4088 27 | 25 | 1 | 2118 | 1/5/60 |
| 4088 28 | 32 | 1 | 2118 | 1/5/60 |
| 4088 29 | 40 | 1 | 2498 | 1/5/60 |
| 4088 30 | 50 | 1 | 2498 | 1/5/60 |
| 4088 31 | 63 | 1 | 2498 | 1/5/60 |

* MRP - Maximum Retail Price Inclusive of all taxes including GST.
 ♦ For further details on product contact nearest Legrand Sales Office.

DX³ MCBs

| Cat.Nos | Nominal Rating | Number of 17.5 mm modules | MRP* ₹ / Unit | Pack |
|---------|----------------|---------------------------|---------------|------|
|---------|----------------|---------------------------|---------------|------|

DX³ RDSO DC MCB

Single Pole

| | | | | |
|---------|-----|---|------|----------|
| 4088 32 | 0.5 | 1 | 1122 | 1/10/120 |
| 4088 33 | 1 | 1 | 1122 | 1/10/120 |
| 4088 34 | 1.5 | 1 | 1122 | 1/10/120 |
| 4088 35 | 1.6 | 1 | 1122 | 1/10/120 |
| 4088 36 | 2.5 | 1 | 1122 | 1/10/120 |
| 4088 37 | 3 | 1 | 821 | 1/10/120 |
| 4088 38 | 4 | 1 | 821 | 1/10/120 |
| 4088 39 | 5 | 1 | 998 | 1/10/120 |
| 4088 40 | 10 | 1 | 998 | 1/10/120 |
| 4088 41 | 15 | 1 | 998 | 1/10/120 |
| 4088 42 | 20 | 1 | 998 | 1/10/120 |
| 4088 43 | 25 | 1 | 998 | 1/10/120 |
| 4088 44 | 30 | 1 | 1139 | 1/10/120 |
| 4088 45 | 35 | 1 | 1139 | 1/10/120 |
| 4088 46 | 40 | 1 | 1267 | 1/10/120 |
| 4088 47 | 50 | 1 | 1267 | 1/10/120 |
| 4088 48 | 60 | 1 | 1267 | 1/10/120 |

DX³ Isolators

Isolators for AC Applications upto 125A

ISI marked as per IEC 60947-3
 Integrated label holder
 Ergonomic red color dolly
 Sliding bottom clamp
 Double break mechanism
 Improved air channels
 Color coded On/Off indication on dolly
 Biconnect lower terminals
 IP 20 protected terminals
 Compatible with signal and control Auxiliaries
 Sliding shutters

Double Pole 240V

| | | | | |
|----------------|-----|---|------|--------|
| 4065 00 | 32 | 2 | 780 | 1/5/60 |
| 4065 01 | 40 | 2 | 858 | 1/5/60 |
| 4065 02 | 63 | 2 | 1134 | 1/5/60 |
| 4065 04 | 100 | 2 | 1557 | 1/5/60 |
| 4065 05 | 125 | 2 | 1771 | 1/5/60 |



4065 00

Triple Pole 415V

| | | | | |
|----------------|-----|---|------|------|
| 4065 09 | 32 | 3 | 1405 | 1/40 |
| 4065 10 | 40 | 3 | 1507 | 1/40 |
| 4065 11 | 63 | 3 | 1794 | 1/40 |
| 4065 13 | 100 | 3 | 1980 | 1/40 |
| 4065 14 | 125 | 3 | 2284 | 1/40 |



4065 10

Four Pole 415V

| | | | | |
|---------|-----|---|------|------|
| 4065 18 | 32 | 4 | 1541 | 1/32 |
| 4065 19 | 40 | 4 | 1914 | 1/32 |
| 4065 20 | 63 | 4 | 2111 | 1/32 |
| 4065 22 | 100 | 4 | 2551 | 1/32 |
| 4065 23 | 125 | 4 | 2811 | 1/32 |



4065 20

Bold Cat.Nos are products normally available with Legrand (India) Stockists. Cat.Nos that are not bold - delivery within 4 - 8 weeks from the date of order. Bold packing quantity is our mandatory packing. Orders to be placed by Legrand (India) Stockist in multiples of the same.

RCD

Advanced Protection for Human Safety and Fire Prevention



DX³ RCDs provide fast, precise earth leakage protection that safeguards people from electric shock and helps prevent fire risks caused by faulty wiring or insulation. They integrate seamlessly within distribution boards, enabling reliable circuit monitoring, advanced control, and remote signalling through modular auxiliary devices.

Features

- Earth leakage protection from 30 mA to 300 mA
- Clip-on auxiliary modules for signalling, shunt release, undervoltage protection, and motorized control
- Integrated test button and robust assembly for reliable fault detection

Benefits

- Simplifies upgrades with tool-free auxiliary installation and modular compatibility
- Improves reliability through precise fault detection



Variants

Type AC

Detects residual alternating currents for standard applications with sinusoidal fault currents

Type A

Detects AC and pulsating DC residual currents for circuits with electronic devices and rectifiers

Type S

Time-delayed tripping for selectivity with downstream RCDs

Type Hpi

High-immunity protection designed to prevent unwanted tripping in disturbed environments (generators, computers, printers)



Scan to know more about the product.

RCCBs for AC Applications Upto 63A

| Cat.Nos | Nominal Rating | Number of 17.5 mm modules | MRP* ₹ / Unit | Pack |
|---------|----------------|---------------------------|---------------|------|
|---------|----------------|---------------------------|---------------|------|

DX³ RCCBs

RCCBs for AC Applications Upto 63A

ISI marked as per IS 12640-1
Integrated label holder
Ergonomic Grey color dolly
Sliding bottom clamp
Compatible with signal and control Auxiliaries
Color coded On/Off indication on dolly
Biconnect lower terminals
IP 20 protected terminals
35 sq mm terminals
Sliding shutters

Type - AC

Sensitive to residual alternating currents
Use : standard applications

Double Pole 240V

30 mA

| | | | | |
|---------|----|---|------|--------|
| 4118 51 | 25 | 2 | 4565 | 1/5/60 |
| 4118 52 | 40 | 2 | 5300 | 1/5/60 |
| 4118 53 | 63 | 2 | 6515 | 1/5/60 |

100 mA

| | | | | |
|---------|----|---|------|--------|
| 4118 56 | 25 | 2 | 5028 | 1/5/60 |
| 4118 57 | 40 | 2 | 5807 | 1/5/60 |
| 4118 58 | 63 | 2 | 6914 | 1/5/60 |

300 mA

| | | | | |
|---------|----|---|------|--------|
| 4118 61 | 25 | 2 | 5114 | 1/5/60 |
| 4118 62 | 40 | 2 | 6100 | 1/5/60 |
| 4118 63 | 63 | 2 | 6942 | 1/5/60 |

Four Pole 415V

30 mA

| | | | | |
|---------|----|---|------|------|
| 4118 76 | 25 | 4 | 6451 | 1/32 |
| 4118 77 | 40 | 4 | 6613 | 1/32 |
| 4118 78 | 63 | 4 | 7357 | 1/32 |

100 mA

| | | | | |
|---------|----|---|------|------|
| 4118 81 | 25 | 4 | 6802 | 1/32 |
| 4118 82 | 40 | 4 | 6882 | 1/32 |
| 4118 83 | 63 | 4 | 8094 | 1/32 |

300 mA

| | | | | |
|---------|----|---|------|------|
| 4118 86 | 25 | 4 | 7006 | 1/32 |
| 4118 87 | 40 | 4 | 7109 | 1/32 |
| 4118 88 | 63 | 4 | 8122 | 1/32 |

Type- S

Delayed trip for discrimination with other residual current devices.
Use : for discrimination with a downstream device

Double Pole 415V, A-S

300 mA

| | | | | |
|---------|----|---|------|--------|
| 4118 66 | 25 | 2 | 9058 | 1/5/60 |
| 4118 67 | 40 | 2 | 9510 | 1/5/60 |
| 4118 68 | 63 | 2 | 9786 | 1/5/60 |

Four Pole 415 V, A-S

300 mA

| | | | | |
|---------|----|---|-------|--------|
| 4118 91 | 25 | 4 | 10200 | 1/5/60 |
| 4118 92 | 40 | 4 | 10331 | 1/5/60 |
| 4118 93 | 63 | 4 | 10794 | 1/5/60 |

RCCBs for AC Applications Upto 63A

| Cat.Nos | Nominal Rating | Number of 17.5 mm modules | MRP* ₹ / Unit | Pack |
|---------|----------------|---------------------------|---------------|------|
|---------|----------------|---------------------------|---------------|------|

Type HPI

Enhanced immunity to unwanted tripping in environments with disturbances. eg. diesels, computers, printers, etc.
• Detects faults with DC components eg. thyristors, triac etc.

Double Pole 240V HPI

30 mA

| | | | | |
|---------|----|---|-------|--------|
| 4118 71 | 25 | 2 | 9905 | 1/5/60 |
| 4118 72 | 40 | 2 | 10399 | 1/5/60 |
| 4118 73 | 63 | 2 | 10701 | 1/5/60 |

Four Pole 415V HPI

30 mA

| | | | | |
|---------|----|---|-------|------|
| 4118 96 | 25 | 4 | 11220 | 1/32 |
| 4118 97 | 40 | 4 | 11574 | 1/32 |
| 4118 98 | 63 | 4 | 11873 | 1/32 |

DX³ RCBOs

RCBOs Assembled for AC Applications upto 63A

ISI marked as per IS 12640-2
Integrated label holder
Ergonomic design
Color coded On/Off indication on dolly
Compatible with signal and control Auxiliaries
Front face indication for earth leakage fault
IP 20 protected terminals
35 sq mm terminals
Sliding shutters

Type - AC

Sensitive to residual alternating currents
Use : standard applications

Double Pole 240V AC Type

30 mA

| | | | | |
|---------|----|---|------|------|
| 4113 22 | 6 | 4 | 5812 | 1/32 |
| 4113 23 | 10 | 4 | 5812 | 1/32 |
| 4113 24 | 16 | 4 | 5812 | 1/32 |
| 4113 25 | 25 | 4 | 5812 | 1/32 |
| 4113 26 | 32 | 4 | 5812 | 1/32 |
| 4113 27 | 40 | 4 | 6983 | 1/32 |
| 4113 28 | 63 | 4 | 8508 | 1/32 |

100 mA

| | | | | |
|---------|----|---|------|------|
| 4113 29 | 6 | 4 | 6991 | 1/32 |
| 4113 30 | 10 | 4 | 6991 | 1/32 |
| 4113 31 | 16 | 4 | 6991 | 1/32 |
| 4113 32 | 25 | 4 | 6991 | 1/32 |
| 4113 33 | 32 | 4 | 6991 | 1/32 |
| 4113 34 | 40 | 4 | 7926 | 1/32 |
| 4113 35 | 63 | 4 | 9147 | 1/32 |

300 mA

| | | | | |
|---------|----|---|------|------|
| 4113 36 | 16 | 4 | 7213 | 1/32 |
| 4113 37 | 25 | 4 | 7213 | 1/32 |
| 4113 38 | 32 | 4 | 7213 | 1/32 |
| 4113 39 | 40 | 4 | 8133 | 1/32 |
| 4113 40 | 63 | 4 | 9163 | 1/32 |

Bold Cat.Nos are products normally available with Legrand (India) Stockists. Cat.Nos that are not bold - delivery within 4 - 8 weeks from the date of order. Bold packing quantity is our mandatory packing. Orders to be placed by Legrand (India) Stockist in multiples of the same.



4118 57



4118 77



4118 83



4118 93



4118 97



4113 24

RCBOs Assembled for AC Applications Upto 63A

| Cat.Nos | Nominal Rating | Number of 17.5 mm modules | MRP* ₹ / Unit | Pack |
|---------|----------------|---------------------------|---------------|------|
|---------|----------------|---------------------------|---------------|------|

Four Pole 415V, AC Type 30 mA

| | | | | |
|---------|----|---|------|------|
| 4113 65 | 16 | 7 | 7781 | 1/16 |
| 4113 66 | 25 | 7 | 7781 | 1/16 |
| 4113 67 | 32 | 7 | 7781 | 1/16 |
| 4113 68 | 40 | 7 | 8167 | 1/16 |
| 4113 69 | 63 | 7 | 9368 | 1/16 |

Four Pole 415V, AC Type 100 mA

| | | | | |
|---------|----|---|-------|------|
| 4113 70 | 16 | 7 | 8770 | 1/16 |
| 4113 71 | 25 | 7 | 8770 | 1/16 |
| 4113 72 | 32 | 7 | 8770 | 1/16 |
| 4113 73 | 40 | 7 | 9099 | 1/16 |
| 4113 74 | 63 | 7 | 10013 | 1/16 |

Four Pole 415V, AC Type 300 mA

| | | | | |
|---------|----|---|-------|------|
| 4113 75 | 16 | 7 | 9122 | 1/16 |
| 4113 76 | 25 | 7 | 9122 | 1/16 |
| 4113 77 | 32 | 7 | 9112 | 1/16 |
| 4113 78 | 40 | 7 | 9547 | 1/16 |
| 4113 79 | 63 | 7 | 10189 | 1/16 |



4113 79

RCBOs Compact for AC Applications

upto 32A, 6kA

Conforms to IEC 60947

Integrated label holder

Ergonomic design

Color coded On/Off indication on dolly

Front face indication for earth leakage fault

IP 20 protected terminals

35 sq mm terminals

Sliding shutters

Type- AC

Sensitive to residual alternating currents

Use : standard applications

Double Pole 240V, AC Type

30 mA

| | | | | |
|---------|----|---|------|------|
| 4113 90 | 6 | 2 | 6909 | 1/32 |
| 4113 91 | 10 | 2 | 6909 | 1/32 |
| 4113 92 | 16 | 2 | 6909 | 1/32 |
| 4113 93 | 20 | 2 | 6909 | 1/32 |
| 4113 94 | 25 | 2 | 6909 | 1/32 |
| 4113 95 | 32 | 2 | 6909 | 1/32 |



4113 94

300 mA

| | | | | |
|---------|----|---|------|------|
| 4113 97 | 6 | 2 | 7243 | 1/32 |
| 4113 98 | 10 | 2 | 7243 | 1/32 |
| 4113 99 | 16 | 2 | 7243 | 1/32 |
| 4114 00 | 20 | 2 | 7243 | 1/32 |
| 4114 01 | 25 | 2 | 7243 | 1/32 |
| 4114 02 | 32 | 2 | 7243 | 1/32 |

* MRP - Maximum Retail Price Inclusive of all taxes including GST.

RCBOs Compact for AC Applications

| Cat.Nos | Description | Number of 17.5 mm modules | MRP* ₹ / Unit | Pack |
|---------|-------------|---------------------------|---------------|------|
|---------|-------------|---------------------------|---------------|------|

Four Pole 415V, AC Type 30 mA

| | | | | |
|---------|----|---|------|------|
| 4114 18 | 10 | 4 | 9440 | 1/16 |
| 4114 19 | 16 | 4 | 9440 | 1/16 |
| 4114 20 | 20 | 4 | 9440 | 1/16 |
| 4114 21 | 25 | 4 | 9440 | 1/16 |

Four Pole 415V, AC Type 300 mA

| | | | | |
|---------|----|---|-------|------|
| 4114 23 | 10 | 4 | 10846 | 1/16 |
| 4114 24 | 16 | 4 | 10846 | 1/16 |
| 4114 25 | 20 | 4 | 10846 | 1/16 |
| 4114 26 | 25 | 4 | 10846 | 1/16 |

Type HPI

Enhanced immunity to unwanted tripping in environments with disturbances. eg. diesels, computers, printers, etc.

• Detects faults with DC components eg. thyristors, trio etc.

Double Pole 240V, HPI Type

30 mA

| | | | | |
|---------|----|---|-------|------|
| 4114 15 | 25 | 2 | 13395 | 1/32 |
| 4114 16 | 32 | 2 | 13395 | 1/32 |

Type A

Sensitive to residual alternating currents and residual currents with a DC component.

Use : special applications

- if it is possible that the fault currents are not purely sinusoidal (rectifier bridge, etc.)

Four Pole 415V, A Type

30 mA

| | | | | |
|---------|----|---|-------|------|
| 4114 28 | 10 | 4 | 10646 | 1/16 |
| 4114 29 | 16 | 4 | 10646 | 1/16 |
| 4114 30 | 20 | 4 | 10646 | 1/16 |
| 4114 31 | 25 | 4 | 10646 | 1/16 |

Four Pole 415V, A Type

300 mA

| | | | | |
|---------|----|---|-------|------|
| 4114 33 | 10 | 4 | 12001 | 1/16 |
| 4114 34 | 16 | 4 | 12001 | 1/16 |
| 4114 35 | 20 | 4 | 12001 | 1/16 |
| 4114 36 | 25 | 4 | 12001 | 1/16 |

DX³ RCD Add on Module

For 125A

Conform to IEC 61009-1

AC type : detect AC components faults

Hpi type : detect faults with AC and DC components, increased

Immunity to false tripping

For mounting on the right-hand side of 1.5 module per pole DX³ MCBs

Easy & fast association mechanism

Terminal cover for locking

70 sq mm terminals

Bold Cat.Nos are products normally available with Legrand (India) Stockists. Cat.Nos that are not bold - delivery within 4 - 8 weeks from the date of order. Bold packing quantity is our mandatory packing. Orders to be placed by Legrand (India) Stockist in multiples of the same.

DX³ RCD Add on Module



4105 68

| Cat.Nos | Nominal Rating | Number of 17.5 mm modules | MRP* ₹ / Unit | Pack |
|---------|----------------|---------------------------|---------------|------|
|---------|----------------|---------------------------|---------------|------|

Double pole 240V, AC type

30 mA

| | | | | |
|---------|-------|---|-------|---|
| 4105 68 | 125 A | 4 | 20780 | 1 |
|---------|-------|---|-------|---|

100 mA

| | | | | |
|---------|-------|---|-------|---|
| 4105 69 | 125 A | 4 | 23433 | 1 |
|---------|-------|---|-------|---|

300 mA

| | | | | |
|---------|-------|---|-------|---|
| 4105 71 | 125 A | 4 | 23433 | 1 |
|---------|-------|---|-------|---|

Four Pole 415V, AC Type

30 mA

| | | | | |
|---------|-------|---|-------|---|
| 4106 25 | 125 A | 4 | 30967 | 1 |
|---------|-------|---|-------|---|

100 mA

| | | | | |
|---------|-------|---|-------|---|
| 4106 26 | 125 A | 4 | 34604 | 1 |
|---------|-------|---|-------|---|

300 mA

| | | | | |
|---------|-------|---|-------|---|
| 4106 29 | 125 A | 4 | 34604 | 1 |
|---------|-------|---|-------|---|

Double Pole 240V, HPI Type

30 mA

| | | | | |
|---------|-------|---|-------|---|
| 4105 78 | 125 A | 6 | 25957 | 1 |
|---------|-------|---|-------|---|

100 mA

| | | | | |
|---------|-------|---|-------|---|
| 4105 79 | 125 A | 6 | 29014 | 1 |
|---------|-------|---|-------|---|

300 mA

| | | | | |
|---------|-------|---|-------|---|
| 4105 82 | 125 A | 6 | 29014 | 1 |
|---------|-------|---|-------|---|

Four Pole 415V, HPI Type

30 mA

| | | | | |
|---------|-------|---|-------|---|
| 4106 38 | 125 A | 6 | 42911 | 1 |
|---------|-------|---|-------|---|

100 mA

| | | | | |
|---------|-------|---|-------|---|
| 4106 39 | 125 A | 6 | 45306 | 1 |
|---------|-------|---|-------|---|

300 mA

| | | | | |
|---------|-------|---|-------|---|
| 4106 42 | 125 A | 6 | 45306 | 1 |
|---------|-------|---|-------|---|

DX³ Auxiliaries

Auxiliaries Common for MCBs, Isolators, RCCBs & RCBOs

Easy & fast fixation on site

On site clip on mounting

Clip on fitting on left side

Signalling Auxiliaries

| | | | | |
|---------|--|-----|------|---|
| 4062 50 | Auxiliary changeover switch 6 A | 0.5 | 1490 | 1 |
| 4062 52 | Fault signalling changeover switch 6 A | 0.5 | 1737 | 1 |
| 4062 64 | Changeover + fault signalling switch | 1 | 2751 | 1 |



4062 50



4062 52

DX³ Auxiliaries

| Cat.Nos | Description | Number of 17.5 mm modules | MRP* ₹ / Unit | Pack |
|---------|-------------|---------------------------|---------------|------|
|---------|-------------|---------------------------|---------------|------|

Control Auxiliaries

| | | | | |
|---------|------------------------------------|---|------|---|
| 4062 76 | Shunt release 12 /48 V AC/ DC | 1 | 3827 | 1 |
| 4062 78 | Shunt release 110/415 V V AC | 1 | 3827 | 1 |
| 4062 80 | Undervoltage release 24/48 V AC/DC | 1 | 3259 | 1 |
| 4062 82 | Undervoltage release 230 V AC | 1 | 3259 | 1 |



4062 78



4062 82

Control Auxiliaries

| | | | | |
|---------|----------------------------------|---|-------|---|
| 4062 86 | POP over voltage release | 1 | 4154 | 1 |
| 4062 90 | Motor control 24/48 V AC/ DC | 1 | 14975 | 1 |
| 4062 91 | Motor control 110/415 V AC | 1 | 14975 | 1 |
| 4062 93 | Motor control 24/48 V AC/ DC | 2 | 28193 | 1 |
| 4062 95 | Motor control 110/415 V AC | 2 | 26629 | 1 |
| 4062 88 | Automatic resetter | 2 | 19886 | 1 |
| 4062 89 | Automatic resetter with autotest | 2 | 24888 | 1 |

Rotary Handle

| | | | | |
|---------|--------------------------|---|------|----|
| 4063 19 | Black rotary handle | - | 3110 | 10 |
| 4063 20 | Yellow/red rotary handle | - | 3365 | 10 |

Support for Padlock

| | | | | |
|---------|-------------------------------|---|-----|----|
| 4063 03 | Support for padlock till 63 A | - | 720 | 10 |
|---------|-------------------------------|---|-----|----|

Sealable Screw Cover

| | | | | |
|---------|----------------------|---|------|----|
| 4063 04 | Devices upto 63 A | - | 713 | 10 |
| 4063 06 | For 80-125 A devices | - | 1244 | 10 |

1/2 Module Spacing Unit

| | | | | |
|---------|-------------------------|-----|-----|----|
| 4063 07 | 1/2 module spacing unit | 0.5 | 262 | 10 |
|---------|-------------------------|-----|-----|----|

5 mm Padlock

| | | | | |
|---------|--------------|-----|-----|----|
| 4063 13 | 5 mm Padlock | 0.5 | 610 | 10 |
|---------|--------------|-----|-----|----|

* MRP - Maximum Retail Price Inclusive of all taxes including GST.

Bold Cat.Nos are products normally available with Legrand (India) Stockists. Cat.Nos that are not bold - delivery within 4 - 8 weeks from the date of order. Bold packing quantity is our mandatory packing. Orders to be placed by Legrand (India) Stockist in multiples of the same.

DX³ Auxiliaries

| Cat.Nos | Description | Number of 17.5 mm modules | MRP* ₹ / Unit | Pack |
|---------|-------------|---------------------------|---------------|------|
|---------|-------------|---------------------------|---------------|------|

Manual Changerover Switch

Compact design
Manual switching operation
Easy to assemble
Ergonomic design

For 1 Mod/Pole Devices

| | | | | |
|---------|----------------------------------|---|------|---|
| 4063 14 | Manual change-over switch for DP | 1 | 3531 | 5 |
| 4063 15 | Manual change-over switch for TP | 1 | 4078 | 5 |
| 4063 16 | Manual change-over switch for FP | 1 | 4531 | 5 |

DX³ RCD add on Module

With Measurement & Metering

| Cat.Nos | Nominal Rating | Number of 17.5 mm modules | MRP* ₹ / Unit | Pack |
|---------|----------------|---------------------------|---------------|------|
|---------|----------------|---------------------------|---------------|------|

Conform to IEC 61009-1
Hpi type: detect faults with AC and DC components, increased
Immunity to false tripping
Inbuilt measurement/metering option
Measurement - V, A, F, PF, KWh, KVA, KVAh, THD
Metering - V, A, F, KWh
RS 485 port for remote reading
Di-electric test button inbuilt
Ergonomic test button
Scroll button for easy readings
RLCD display on front facia
For mounting on the right-hand side of 1.5 module per pole DX3 MCBs
Easy & fast association mechanism
70 sq mm terminals

Adjustable Metering, Four Pole 415 V

| | | | | |
|---------|-------|---|-------|---|
| 4106 57 | 63 A | 7 | 22772 | 1 |
| 4106 58 | 125 A | 7 | 40861 | 1 |

Adjustable Measurement

| | | | | |
|---------|-------|---|-------|---|
| 4106 59 | 125 A | 7 | 44518 | 1 |
|---------|-------|---|-------|---|

DX³ Time Switches

| Cat.Nos | Description | No. of Modules | MRP* ₹ / Unit | Pack |
|---------|-------------|----------------|---------------|------|
|---------|-------------|----------------|---------------|------|

For Switching an Electric Circuit (Lighting, Heating) on Or Off at Selected Times During a Pre-Programmed Time Period.

Alpharex3 Digital Time Swiches Weekly Time Switch

Time-saving programming by selection of daily blocks, daily blocks individually adjustable or selection from preset blocks Mo-Fr and Mo-Su
Permanent ON or OFF
Circuit anticipation
Power reserve 3 years for date, time and switching program
Accuracy +/- 1 sec./Day

* MRP - Maximum Retail Price Inclusive of all taxes including GST.

DX³ Time Switches

| Cat.Nos | Description | No. of Modules | MRP* ₹ / Unit | Pack |
|---------|-------------|----------------|---------------|------|
|---------|-------------|----------------|---------------|------|

| | | | | |
|---------|--|---|------|---|
| 0037 10 | Power supply 230 V~ 50/60Hz 1 NO contact 250 V/50 Hz 16 A - cos ϕ = 1 28 programmes Shortest switching-time 1 min | 1 | 7514 | 1 |
|---------|--|---|------|---|

Multiple Functions - Daily or Weekly Time Switch Programme - 5 Years Clock Working Reserve

Programme settings: on daily or weekly basis
15 languages
A programme consists of a on and off time and their assignement to certain days
Option to suspend the programme for a specific period to set-up with start and date
Minimum programme setting: 1 s.
High precision clock: \pm 0.1 sec per day
Particularly suited to irregular cycles:
- security installations (access point, alarms, etc.),
- industrial installations (pump stations, etc.)
Programmed directly on keypad, or using program transfer key Cat.No 4 128 72
Additional functions including random (irregular cycles), hour counters

| | | | | |
|---------|--|---|-------|---|
| 4126 31 | 1 output 16 A - 250 V~ - 50/60 Hz 56 programmes 1 Channel | 2 | 8765 | 1 |
| 4126 41 | 2 output 16 A - 250 V~ - 50/60Hz 2x28 programmes 2 Channel | 2 | 12451 | 1 |



4126 41

Digital Time Switch with Astronomical Function

- For switching on/off lights and other electric devices according to the rising/setting of the sun
- With combination function for creating switching programs in which the devices are switched according to astronomical time and/or fixed preset times
- Daily astronomical calculation of the sunrise/sunset times based on the entered location or location coordinates

| | | | | |
|---------|---|---|-------|---|
| 4126 54 | 1 output 16 A - 250 V~ 50/60 Hz Astronomical function 56 Programmes 1 Channel | 2 | 15512 | 1 |
| 4126 57 | 2 output 16 A - 250 V~ 50/60 Hz Astronomical function 2x28 programmes 2 Channel | 2 | 17702 | 1 |



4126 54



4126 57

Alpharex³ Yearly Time Switch

- Yearly and weekly time switch with additional astronomical function for all channels
- 84 switching programs per channel, comprising:
 - 28 weekly programs
 - 28 yearly programs
 - 28 special programs (priority program)

| | | | | |
|---------|---|---|-------|---|
| 4126 30 | 2 outputs - 230 V~ 50/60 Hz Astronomical function 2 x 3 x 28 = 168 programmes | 2 | 29037 | 1 |
|---------|---|---|-------|---|

Bold Cat.Nos are products normally available with Legrand (India) Stockists. Cat.Nos that are not bold - delivery within 4 - 8 weeks from the date of order. Bold packing quantity is our mandatory packing. Orders to be placed by Legrand (India) Stockist in multiples of the same.



4106 57

Dx³ Time Switches

| Cat.Nos | Description | MRP* ₹ / Unit | Pack |
|--------------------------------|---|------------------|------|
| Programming Accessories | | | |
| 4128 72 | Programming transfer key Can be used to store programme settings made: Directly on a multifunction and multi-programme time switch Cat.Nos 4 126 30/31/32/33/41/54/57 (loading on device) -with the programming software installed on a PC running Windows (loading on data loader) | 3262 | 1 |
| 4128 73 | Programming software Kit Can be used to create, save and transfer program settings for multi-function and multi-program time switches, Data is transferred to the program transfer key using the data loader connected to the USB port of the PC. 4128 73 Kit comprising software on CD-ROM, data loader and transfer key Windows XP, Windows 7, Windows 8 compatible" | 6960 | 1 |

Twilight Switches

- Light sensitive switches
- Can be used to switch a lighting circuit "ON" and "OFF" based on light conditions (nightfall, daybreak)
- Supplied with IP 65 weatherproof photoelectric cell
- Adjustable from 1 to 100 000 lux

| | | | |
|---------|---|-------|---|
| 4126 23 | Luxo Switch / Light sensitive switch with Lux Sensor - Output 16 A 250 V~ | 11092 | 1 |
|---------|---|-------|---|

MicroRex Analog Time Switches

Programmed via captive segment
Power supply: 230 V~ 50/60 Hz
3-position override switch "ON-AUTO-OFF" on front panel

Manual changeover to summer/winter time
1 outlet 16 A - 250 V~ - $\mu \cos = 1$

Analogue Time Switch Daily Programme

1 segment = 15 minutes

Accuracy: ± 5 minutes

1 outlet 16 A - 250 V~ - $\mu \cos = 1$

| | | | | |
|---------|--|---|------|---|
| 4127 80 | Vertical Dial N/O Contact - without working Reserve -Minimum switching time: 15 minutes | 1 | 4571 | 1 |
| 4127 90 | Vertical Dial N/O Contact - with 100 h working Reserve -Minimum switching time: 15 minutes | 1 | 5383 | 1 |

* MRP - Maximum Retail Price Inclusive of all taxes including GST.



4128 12

Power Contactors / Modular Contactors CX³

| Cat.Nos | Description | MRP* ₹ / Unit | Pack | |
|---------|---|------------------|------|---|
| 4128 12 | Horizontal Dial Changeover Switch - without working Reserve -Minimum switching time: 15 minutes | 3 | 6768 | 1 |
| 4128 13 | Horizontal Dial Changeover Switch - with 100 h working Reserve -Minimum switching time: 15 minutes | 3 | 8383 | 1 |

Analogue Time Switch Weekly Programme

1 segment = 2 hours

Accuracy: ± 30 minutes

1 outlet 16 A - 250 V~ - $\mu \cos = 1$

| | | | | |
|---------|--|---|------|---|
| 4127 94 | Vertical Dial N/O Contact - with 100 h working Reserve -Minimum switching time: 2 hours | 1 | 5848 | 1 |
| 4127 95 | Horizontal Dial Changeover Switch - with 100 h working Reserve -Minimum switching time: 4 hours | 3 | 8470 | 1 |

DX³ Contactors

Power Contactors / Modular Contactors CX³

Conform to IEC/EN 61095

Space for power supply busbar on top (up to 25 A)

Power contactors with 230 V~ coil and handle

Manual override for test and repair function, carried out via the handle

Permanent "ON" or "OFF" without automatic closing of the contactor

| | | | |
|---------|---------------------|-------|---|
| 4125 44 | 25 A 2 NO contactor | 3260 | 1 |
| 4125 45 | 40 A 2 NO contactor | 5560 | 1 |
| 4125 47 | 63 A 2 NO contactor | 6470 | 1 |
| 4125 48 | 63 A 2 NC contactor | 6470 | 1 |
| 4125 49 | 40 A 3 NO contactor | 9300 | 1 |
| 4125 50 | 63 A 3 NO contactor | 10500 | 1 |
| 4125 51 | 25 A 4 NO contactor | 3840 | 1 |
| 4125 53 | 40 A 4 NO contactor | 9810 | 1 |
| 4125 56 | 63 A 4 NO contactor | 11610 | 1 |
| 4125 57 | 63 A 4 NC contactor | 11720 | 1 |

Signalling Auxiliaries for Contactors

Auxiliary changeover switch

| | | | |
|---------|--------------------------------------|------|---|
| 4124 29 | For 1 module contactors 16 A to 25 A | 4770 | 1 |
| 4124 30 | For 2 module contactors 25 A | 4790 | 1 |
| 4124 31 | For 2 module contactors 25 A | 6280 | 1 |

Bold Cat.Nos are products normally available with Legrand (India) Stockists. Cat.Nos that are not bold - delivery within 4 - 8 weeks from the date of order. Bold packing quantity is our mandatory packing. Orders to be placed by Legrand (India) Stockist in multiples of the same.

DX³ for Photovoltaic Applications

| Cat.Nos | Description | MRP* ₹ / Unit | Pack |
|---------|-------------|---------------------|------|
|---------|-------------|---------------------|------|

DC MCBs

Breaking capacity 4.5 kA according to EN 60947-2

800 V= Circuit Breakers

| | | | |
|---------|------|------|---|
| 4144 24 | 6 A | 9232 | 1 |
| 4144 25 | 8 A | 9232 | 1 |
| 4144 26 | 10 A | 9232 | 1 |
| 4144 27 | 13 A | 9232 | 1 |
| 4144 28 | 16 A | 9232 | 1 |
| 4144 29 | 20 A | 9232 | 1 |

1000 V= Circuit Breakers

| | | | |
|---------|------|-------|---|
| 4144 46 | 10 A | 24738 | 1 |
| 4144 47 | 13 A | 24738 | 1 |
| 4144 48 | 16 A | 24738 | 1 |
| 4144 49 | 20 A | 24738 | 1 |

DC Rotary Handle Isolating Switches

Category of use DC 21B according to EN 60947-3

Double break contacts

600 V= isolating switches

| | | | |
|---------|------|-------|---|
| 4142 61 | 16 A | 10408 | 1 |
| 4142 62 | 25 A | 11756 | 1 |
| 4142 63 | 32 A | 11756 | 1 |

* MRP - Maximum Retail Price Inclusive of all taxes including GST.

| Cat.Nos | Description | MRP* ₹ / Unit | Pack |
|---------|-------------|---------------------|------|
|---------|-------------|---------------------|------|

1000 V= Isolating Switches

| | | | |
|---------|------|-------|---|
| 4142 81 | 16 A | 20154 | 1 |
| 4142 82 | 25 A | 20110 | 1 |
| 4142 83 | 32 A | 20902 | 1 |

Accessories

| | | | |
|---------|-------------------------|-----|----|
| 4063 05 | Pole separation divider | 196 | 1 |
| 4063 07 | Spacing unit 0.5 unit | 262 | 10 |

Bold Cat.Nos are products normally available with Legrand (India) Stockists. Cat.Nos that are not bold - delivery within 4 - 8 weeks from the date of order. Bold packing quantity is our mandatory packing. Orders to be placed by Legrand (India) Stockist in multiples of the same.

Surge Protective Devices (SPDs)

Reliable Protection Against Lightning & Power Surges



Surge Protective Devices protect electrical installations from lightning-induced overvoltages and power surges. Designed for residential, commercial, industrial, and photovoltaic systems, they safely divert surge energy to earth to help maintain reliable and continuous power distribution.

Features

- Type 1 and T1+T2 SPDs with impulse current capacity from 12.5 kA to 100 kA
- Type 2 SPDs with surge capacity from 20 kA to 45 kA
- PV and DC SPDs supporting photovoltaic systems up to 1500 V
- Plug-in modular design with status indicators for quick replacement and easy maintenance

Benefits

- Prevents damage to costly electrical & electronic equipment
- Improves system reliability by reducing downtime and power interruptions
- Enables faster installation and maintenance with modular design
- Supports a wide range of electrical and solar power installations



T1 SPDs

are designed to provide protection in the main distribution board.

T1+T2 SPDs

are increasingly used at the supply end of installations and comply with the specifications of both T1 and T2 SPDs.

T2 SPDs

typically provide protection in secondary distribution boards or consumer units.

Scan to know more about the product.



Low Voltage SPDs

| Cat.Nos | Number of poles | Neutral position | I total (10/350) | Remote status monitoring (logging contact) | Number of modules | MRP* ₹ / Unit |
|---------|-----------------|------------------|------------------|--|-------------------|---------------|
|---------|-----------------|------------------|------------------|--|-------------------|---------------|

SPDs for General Protection of Main Distribution Board

T1+T2 - limp 12,5 kA/pole T2 - 60 kA

| | | | | | | |
|----------------------|------|-------|---------|-----|---|-------|
| 4122 70 | 1P | - | 12.5 kA | No | 1 | 10582 |
| 4122 76 ¹ | 1P+N | Right | 25 kA | Yes | 2 | 18619 |
| 4122 71 | 2P | - | 25 kA | No | 2 | 20433 |
| 4122 72 | 3P | - | 37.5 kA | Yes | 3 | 25332 |
| 4122 77 ¹ | 3P+N | Right | 50 kA | Yes | 4 | 33944 |
| 4122 73 | 4P | - | 50 kA | No | 4 | 35000 |

T1+T2 - limp 8 kA/pole T2 - 60 kA

| | | | | | | |
|----------------------|------|-------|-------|----|---|---|
| 4122 50 | 1P | - | 8 kA | No | 1 | ■ |
| 4122 56 ¹ | 1P+N | Right | 16 kA | No | 2 | ■ |
| 4122 51 | 2P | - | 16 kA | No | 2 | ■ |
| 4122 52 | 3P | - | 25 kA | No | 3 | ■ |
| 4122 57 ¹ | 3P+N | Right | 25 kA | No | 4 | ■ |
| 4122 53 | 4P | - | 32 kA | No | 4 | ■ |

SPDs for High Risk Level Installations

T1 - limp 35 kA/pole - 440 V± (IT) - Plug-in

| | | | | | | |
|---------|----|---|-------|-----|---|-------|
| 4122 80 | 1P | - | 35 kA | Yes | 2 | 23419 |
|---------|----|---|-------|-----|---|-------|

T1 - limp 25 kA/pole

| | | | | | | |
|----------------------|------|-------|--------|-----|---|-------|
| 4122 81 ¹ | 1P+N | Right | 50 kA | Yes | 4 | 30429 |
| 4122 82 | 3P | - | 75 kA | Yes | 6 | 72748 |
| 4122 83 ¹ | 3P+N | Right | 100 kA | Yes | 8 | 83500 |

Replacement Plug-In Modules

| Cat.Nos | Description | MRP* ₹ / Unit | Pack |
|---------|---|---------------|------|
| 4123 02 | For SPDs T1+T2 - 8 kA Cat.Nos 4122 50/ 51/52/53/56/57 | 8314 | 1 |
| 4123 03 | For SPDs T1+T2 - 12.5 kA Cat.Nos 4122 70/ 71/72/73/76/77 | 7844 | 1 |
| 4122 84 | For SPDs T1 - 25 kA Cat.Nos 4122 81/82/83 and 0030 20/22/23/27 | 22791 | 1 |
| 4122 85 | N-PE module for SPDs T1 - 25 kA Cat.Nos 4122 81/83 and 0030 23 | 30931 | 1 |
| 4122 86 | For SPDs T1 - 35 kA Cat.No 4122 80 | 7644 | 1 |

Low Voltage SPDs

| Cat.Nos | Description | MRP* ₹ / Unit | Pack |
|---------|-------------|---------------|------|
|---------|-------------|---------------|------|

Cabling Accessories

| | | | |
|---------|--|------|---|
| 4123 10 | Ready to use cabling kit consisting of 5 conductors (including the earth conductor) Cross section :16 mm ² Lenght : 40 cm For cabling SPDs in industrial enclosures (for EN/IEC 61439 compliance). | 1636 | 1 |
|---------|--|------|---|

T2 SPDs

T2 - I_{max} 40 kA/pole

| | | | | | | |
|----------------------|------|-------|-----|---|---|---|
| 4122 40 | 1P | - | No | 1 | ■ | 1 |
| 4122 46 ¹ | 1P+N | Right | No | 2 | ■ | 1 |
| 4122 41 | 2P | - | No | 2 | ■ | 1 |
| 4122 42 | 3P | - | Yes | 3 | ■ | 1 |
| 4122 47 ¹ | 3P+N | Right | No | 4 | ■ | 1 |
| 4122 43 | 4P | - | No | 4 | ■ | 1 |

T2 - I_{max} 40 kA/pole - 440 V~ (IT)

| | | | | | | |
|---------|----|---|-----|---|---|---|
| 4122 30 | 1P | - | No | 1 | ■ | 1 |
| 4122 32 | 3P | - | Yes | 3 | ■ | 1 |
| 4122 33 | 4P | - | Yes | 4 | ■ | 1 |

T2 - I_{max} 20 kA/pole

| | | | | | | |
|----------------------|------|-------|----|---|---|---|
| 4122 20 | 1P | - | No | 1 | ■ | 1 |
| 4122 26 ¹ | 1P+N | Right | No | 2 | ■ | 1 |
| 4122 21 | 2P | - | No | 2 | ■ | 1 |
| 4122 27 ¹ | 3P+N | Right | No | 4 | ■ | 1 |
| 4122 23 | 4P | - | No | 4 | ■ | 1 |

Replacement Plug-In Modules

| | | | |
|---------|---|-------|---|
| 4122 99 | For SPDs T2 - 40 kA Cat.Nos 4122 40/ 41/42/43/44/45/ 46/47/66/67 | 5401 | 1 |
| 4123 00 | N-PE module for SPDs T2 - 40 kA Cat.Nos 4122 46/47 | 10813 | 1 |
| 4123 01 | For SPDs T2 - 440 V Cat.Nos 4122 30/32/33 | ■ | 1 |
| 4122 97 | For SPDs T2 - 20 kA Cat.Nos 4122 20/ 21/23/26/27/62/63 | ■ | 1 |

* MRP - Maximum Retail Price Inclusive of all taxes including GST.
■ Price available on request.



4122 57



4122 43



4122 83



4123 03



4122 84



4122 99

Bold Cat.Nos are products normally available with Legrand (India) Stockists. Cat.Nos that are not bold - delivery within 4 - 8 weeks from the date of order. Bold packing quantity is our mandatory packing. Orders to be placed by Legrand (India) Stockist in multiples of the same.

Low voltage SPDs

Without Short-Circuit Protection

| Cat.Nos | Description | MRP* ₹ / Unit |
|---------|-------------|---------------------|
|---------|-------------|---------------------|

T1+T2 - limp 12.5 kA - Uc 385 VA

Up 1.9 kV, Uc 385 VA

Type 1 characteristics: limp 12.5 kA

Type 2 characteristics: In 30 kA and I_{max} 60 kA

Neutral earthing systems: TT, TN

Protection against short-circuited end of life to be added: gG/gL fuse: 125 A

| | | |
|---------|---|-------|
| 4103 70 | Spd T1+T2/12.5kA 1P 385V | 4860 |
| 4103 74 | Spd T1+T2/12.5kA 1P+N 385V | 7020 |
| 4143 74 | Spdt1+T2/12.5kA1P+N 385v With Status Feedback | 8100 |
| 4103 71 | Spd T1+T2/12.5kA 2P 385V | 9720 |
| 4103 72 | Spd T1+T2/12.5kA 3P 385V | 14580 |
| 4103 75 | Spd T1+T2/12.5kA 3p+N 385V | 16740 |
| 4143 75 | SPD T1+T2/12.5kA 3P+N3 85V with Status Feedback | 17820 |
| 4103 73 | Spd T1+T2/12.5kA 4P 385V | 19440 |



4103 73

Protection for N-PE Application

T1+T2 - limp 25 kA - Uc 260 VA for 1P+N Installations

Up 1.4 kV, Uc 260 VA

Type 1 characteristics: limp 25 kA

Type 2 characteristics: In 30 kA and I_{max} 60 kA

Neutral earthing systems: TT, TN

To be used in combination with one 1P varistor SPD

T1+T2 limp 12.5 kA Uc 175 VA or 385 VA

Cat. Nos 4 103 70 and 4 143 06 to protect the neutral branch

| | | |
|---------|-------------------------------|------|
| 4103 10 | 1P GDT N-EAR SPD T1+T2/12.5kA | 7020 |
|---------|-------------------------------|------|

T1+T2 - limp 50 kA - Uc 260 VA for 3P+N Installations

Up 1.5 kV, Uc 260 VA

Type 1 characteristics: limp 50 kA

Type 2 characteristics: In 30 kA and I_{max} 60 kA

Neutral earthing systems: TT, TN

To be used in combination with three 1P varistor SPDs

T1+T2 limp 12.5 kA Uc 175 VA or 385 VA

Cat. Nos 4 103 70 and 4 143 06 to protect the neutral branch

| | | |
|---------|-------------------------------|------|
| 4103 12 | 1P GDT N-EAR SPD T1+T2/12.5kA | 7020 |
|---------|-------------------------------|------|

* MRP - Maximum Retail Price Inclusive of all taxes including GST.

1 1P+N and 3P+N: L-N and N-PE protection modes (common and differential modes), the N pole being protected by encapsulated spark gaps. Also called sometimes 1+1 and 3+1

Low voltage SPDs

Without Short-Circuit Protection

| Cat.Nos | Description | MRP* ₹ / Unit |
|---------|-------------|---------------------|
|---------|-------------|---------------------|

Plug-in Replacement Modules

| | | |
|---------|------------------------------------|-------|
| 4122 86 | For T1+T2/35 kA SPDs | 7644 |
| 4122 84 | For T1+T2/25 kA SPDs | 22791 |
| 4122 85 | For T1+T2/25 kA SPDs (N-PE module) | 30931 |
| 4103 01 | Plugin Mod SPDT1+T2/12.5KA385V | 3780 |
| 4103 11 | Plugin Mod for 410310 | 5940 |
| 4103 13 | Plug-In Module for 410310 | 5940 |



4122 84



4103 01



4103 13

T1+T2 - T2 - I_{max} 45 kA - Uc 460 VA

Up 2.5 kV, Uc 460 VA

Type 2 characteristic: In 10 kA, I_{max} 20 kA

Neutral earthing systems: TT, TN, IT (PN < 120 V)

Protection against short-circuited end of life to be added: gG/gL fuse: 80 A

| | | |
|---------|---|-------|
| 4143 60 | SPD T2/45 kA1P 460V with Status Feedback | 3780 |
| 4143 61 | SPD T2/45 kA 2P 460V with Status Feedback | 7020 |
| 4143 62 | SPD T2/45 kA 3P 460V with Status Feedback | 9990 |
| 4143 63 | SPD T2/45 kA 4P 460V with Status Feedback | 12960 |

T2 - I_{max} 45 kA - Uc 320 VA

Up 1.8 kV, Uc 320 VA

Type 2 characteristic: In 20 kA, I_{max} 45 kA

Neutral earthing systems: TT, TN

Protection against short-circuited end of life to be added: gG/gL fuse: 80 A

| | | |
|---------|---|-------|
| 4103 40 | SPD T2/45 kA 1P 320V | 2970 |
| 4103 44 | SPD T2/45 kA 1P+N 320V | 4050 |
| 4143 44 | SPD T2/45 kA 1P+N 320V with Status Feedback | 5130 |
| 4103 41 | SPD T2/45 kA 2P 320V | 5940 |
| 4103 42 | SPD T2/45 kA 3P 320V | 8910 |
| 4103 45 | SPD T2/45 kA 3P+N 320V | 9990 |
| 4143 45 | SPD T2/45 kA 3P+N 320V with Status Feedback | 11070 |
| 4103 43 | SPD T2/45 kA 4P 320V | 11880 |



4103 45

Bold Cat.Nos are products normally available with Legrand (India) Stockists. Cat.Nos that are not bold - delivery within 4 - 8 weeks from the date of order. Bold packing quantity is our mandatory packing. Orders to be placed by Legrand (India) Stockist in multiples of the same.

Type 2 (T2) SPDs

Without Short-Circuit Protection

| Cat.Nos | Description | MRP* ₹ / Unit | Pack |
|---------|-------------|------------------|------|
|---------|-------------|------------------|------|

T2 - I_{max} 20 kA - Uc 460 VA

Up 2 kV, Uc 460 VA

Type 2 characteristic: In 20 kA, I_{max} 45 kA

Neutral earthing systems: TT, TN, IT (PN < 120 V)

Protection against short-circuited end of life to be added: gG/gL fuse: 80 A

| | | | |
|---------|---|-------|--|
| 4143 50 | SPD T2/20 kA 1P 460V with Status Feedback | 3618 | |
| 4143 51 | SPD T2/20 kA 2P 460V with Status Feedback | 6156 | |
| 4143 52 | SPD T2/20 kA 3P 460V with Status Feedback | 8694 | |
| 4143 53 | SPD T2/20 kA 4P 460V with Status Feedback | 10152 | |

SPDs Without Short-Circuit Protection

T2 - I_{max} 20 kA - Uc 320 VA

Up 1.2 kV, Uc 320 VA

Type 2 characteristic: In 10 kA, I_{max} 20 kA

Neutral earthing systems: TT, TN

Protection against short-circuited end of life to be added: gG/gL fuse: 80 A

| | | | |
|---------|---|-------|--|
| 4103 20 | SPD T2/20 kA 1P 320V | 2538 | |
| 4103 24 | SPD T2/20 kA 1P+N 320V | 3618 | |
| 4143 24 | SPD T2/20 kA 1P+N 320V with Status Feedback | 4698 | |
| 4103 21 | SPD T2/20 kA 2P 320V | 5076 | |
| 4103 22 | SPD T2/20 kA 3P 320V | 7614 | |
| 4103 25 | SPD T2/20 kA 3P+N 320V | 8694 | |
| 4143 25 | SPD T2/20 kA 3P+N 320V with Status Feedback | 9774 | |
| 4103 23 | SPD T2/20 kA 4P 320V | 10152 | |

Plug-In Replacement Modules

| | | | |
|---------|----------------------------------|------|--|
| 4103 05 | Plugin Mod for SPD T2/45 kA 460V | 2700 | |
| 4103 04 | Plugin Mod for SPD T2/45 kA 320V | 2700 | |
| 4103 03 | Plugin Module SPD T2/20 kA 460V | 2160 | |
| 4103 02 | Plugin Module SPD T2/20 kA 320V | 2160 | |
| 4103 15 | Plugin Mod for 410314 | 2700 | |
| 4103 17 | Plug-In Module for 410316 | 2970 | |



4103 20



4103 24



4103 23



4103 02

Type 2 (T2) SPDs

Without Short-Circuit Protection

| Cat.Nos | Description | MRP* ₹ / Unit | Pack |
|---------|-------------|------------------|------|
|---------|-------------|------------------|------|

Spark Gap SPDs Without Short-Circuit Protection for N-PE Applications

T2 - I_{max} 20 kA - Uc 260 VA for 1P+N Installations

Up 2 kV, Uc 260 VA

Type 2 characteristic: In 20 kA, I_{max} 45 kA

Neutral earthing systems: TT, TN

To be used in combination with one or three 1P varistor SPD T2 I_{max} 20 kA Uc 175 VA or 385 VA

Cat. Nos 4 103 20/80 to protect the neutral branch

| | | | |
|---------|----------------------------------|------|--|
| 4103 14 | 1P GDT N-Earth SPD T2/20 kA 260V | 2700 | |
|---------|----------------------------------|------|--|

T2 - I_{max} 45 kA - Uc 260 VA for 1P+N Installations

Up 2 kV, Uc 260 VA

Type 1 characteristics: I_{imp} 50 kA

Type 2 characteristics: In 30 kA and I_{max} 60 kA

Neutral earthing systems: TT, TN

To be used in combination with one or three 1P varistor SPD T2 I_{max} 45 kA Uc 175 VA or 385 VA

Cat. Nos 4 103 40/90 to protect the neutral branch

| | | | |
|---------|--------------------------------|------|--|
| 4103 16 | 1P GDT N-EAR SPD T2/45 kA 260V | 3240 | |
|---------|--------------------------------|------|--|



4103 16



4103 15

Plug-In Replacement Modules

| | | | |
|---------|---------------------------|------|--|
| 4103 15 | Plugin Mod for 410314 | 2700 | |
| 4103 17 | Plug-In Module for 410316 | 2970 | |

SPDs Without Short-Circuit Protection

T2 - I_{max} 40 kA - Uc 1500 V_{DC}

Up 5 kV, Uc 1500 V_{DC}

Type 2 characteristic: In 18 kA, I_{max} 40 kA

| | | | |
|---------|------------------------------|------|--|
| 4103 58 | SPD for PV T2/40 kA 1500V DC | 9720 | |
|---------|------------------------------|------|--|

T2 - I_{max} 40 kA - Uc 1040 V_{DC}

Up 3.5 kV, Uc 1040 V_{DC}

Type 2 characteristic: In 18 kA, I_{max} 40 kA

| | | | |
|---------|------------------------------|------|--|
| 4103 57 | SPD for PV T2/40 kA 1040V DC | 8640 | |
|---------|------------------------------|------|--|



4103 57



4103 97

Plug-In Replacement Modules

| | | | |
|---------|-------------------------------------|------|--|
| 4103 98 | Plugin Mod PV SPD T2/40 kA 1500V DC | 4320 | |
| 4103 97 | Plugin Mod PV SPD T2/40 kA 1040V DC | 3780 | |

ACCL

Automatic Changeover with Current Limiter

Seamless Power Switching for Smart Electrical Systems



ACCL ensures uninterrupted power by automatically switching between mains and generator supply. Designed with intelligent control and built-in current limiting, it protects the generator from overload while maintaining reliable power continuity for residential and commercial installations.

Features

- Intelligent microcontroller-based design
- Built-in current limiter to prevent generator overload
- Break-before-make switching mechanism with neutral isolation
- LED status indicators with buzzer alerts and manual reset function

Benefits

- Ensures continuous power supply during mains failure
- Protects generator systems from overload damage
- Improves safety through controlled and reliable power transfer
- Simplifies monitoring with clear visual and audible status alerts

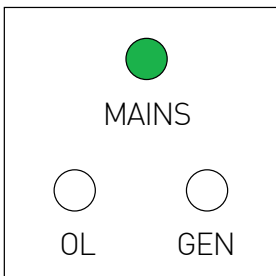

Mains ON

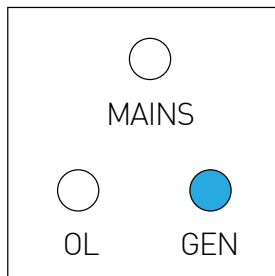

Genset ON

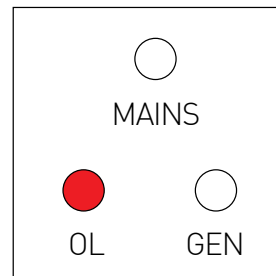

Overload



Scan to know more about the product.

DX³ Changeover Switches

| Cat.Nos | Description | MRP* ₹ / Unit | Pack |
|---------|-------------|------------------|------|
|---------|-------------|------------------|------|

Changeover Switches

Single Pole - Two Way - 250V AC

| | | | |
|---------|------|------|--------|
| 4129 00 | 32 A | 4791 | 10/100 |
|---------|------|------|--------|

Double Pole - Two Way - 400V AC

| | | | |
|---------|------|------|------|
| 4129 01 | 32 A | 4791 | 5/50 |
|---------|------|------|------|

Double Pole - Two Way with Centre Off - 400V AC

| | | | |
|---------|------|------|------|
| 4129 03 | 32 A | 5016 | 5/50 |
|---------|------|------|------|

Four Pole - Two Way with Centre Off - 400V AC

| | | | |
|---------|------|------|------|
| 6040 22 | 40 A | 7769 | 2/20 |
|---------|------|------|------|

Automatic Changeover with Current Limiter(ACCL)

Intelligent micro controller based design

Automatic source change over between Mains & Generator supply

Break before make change over system

Buzzer and Led Indication of status

Current limitation prevents overloading of the generator

| | | | |
|---------|------------|------|------|
| 4053 00 | SPN 30/3A | 3220 | 1/15 |
| 4053 01 | SPN 30/4A | 3220 | 1/15 |
| 4053 02 | SPN 30/5A | 3220 | 1/15 |
| 4053 03 | SPN 30/6A | 3220 | 1/15 |
| 4053 04 | SPN 30/9A | 3220 | 1/15 |
| 4053 05 | SPN 30/12A | 3220 | 1/15 |
| 4053 06 | SPN 30/15A | 3220 | 1/15 |
| 4053 07 | SPN 30/20A | 3220 | 1/15 |
| 4053 08 | SPN 30/30A | 3220 | 1/15 |

DX³ Push Button Push Button Cum Switch - 1 Module - 20A-250V AC

Single Function

| | | | |
|---------|--------------|------|--------|
| 4129 08 | Contact 1 NO | 3958 | 10/100 |
| 4129 09 | Contact 1 NC | 3958 | 10/60 |
| 4129 10 | Contact 2 NO | 3958 | 10/60 |

* MRP - Maximum Retail Price Inclusive of all taxes including GST.

DX³ Indicators

| Cat.Nos | Description | MRP* ₹ / Unit | Pack |
|---------|-------------|------------------|------|
|---------|-------------|------------------|------|

Dual Function

| | | | |
|---------|----------------------------------|------|-------|
| 4129 14 | Contact - 1 NO + green indicator | 3958 | 10/60 |
| 4129 15 | Contact - 1 NC + red indicator | 3958 | 10/60 |

Single Indicators - 1 Module - 250 V AC

Possible to replace E10 lamps and diffusers. E10 - 1.2 Watt, 230 V AC

| | | | |
|---------|-----------------------|------|--------|
| 4129 26 | Colour - Green | 1152 | 10/100 |
| 4129 27 | Colour - Red | 1152 | 10/100 |
| 4129 28 | Colour - Orange | 1152 | 10/100 |
| 4129 29 | Colour - Blue | 1152 | 10/100 |
| 4129 32 | White + White + White | 2102 | 10/100 |
| 4129 33 | Red + Red + Red | 2102 | 10/100 |
| 4129 34 | Red + Yellow + Green | 2102 | 10/100 |
| 4129 35 | Red + Yellow + Blue | 2141 | 10/100 |

MaxiRex

| | | | |
|---------|---------------------|------|------|
| 6499 15 | MaxiRex 4QT (daily) | 9100 | 1/30 |
|---------|---------------------|------|------|

EconoRex

| | | | |
|---------|-----------------------|------|------|
| 0499 86 | EconoRex MQT (24hrs.) | 8803 | 1/30 |
|---------|-----------------------|------|------|

Current Transformers

- Used with ammeters, electricity meters
- Supply a current of 5 A to the secondary which is proportional to the primary current.
- Fix to plate or rail EN 60715

| | | | |
|---------|---|------|------|
| 4121 01 | 50/5 Precision in % - 1 Power in VA - 1.5 | 3852 | 1/12 |
| 4121 03 | 100/5 Precision in % - 1 Power in VA - 1.5 | 5240 | 1/12 |
| 4121 06 | 200/5 Precision in % - 0.5 Power in VA - 4 | 5240 | 1/12 |
| 4121 24 | 200/5 Precision in % - 0.5 Power in VA - 5 | 4960 | 1/12 |
| 4121 25 | 400/5 Precision in % - 0.5 Power in VA - 8 | 5140 | 1/12 |
| 4121 36 | 600/5 Precision in % - 0.5 Power in VA - 12 | 5220 | 1/12 |
| 4121 38 | 800/5 Precision in % - 0.5 Power in VA - 8 | 7640 | 1/12 |
| 4121 39 | 1000/5 Precision in % - 0.5 Power in VA - 10 | 8080 | 1/12 |
| 4121 42 | 1250/5 Precision in % - 0.5 Power in VA - 12 | 9420 | 1/12 |

Bold Cat.Nos are products normally available with Legrand (India) Stockists. Cat.Nos that are not bold - delivery within 4 - 8 weeks from the date of order. Bold packing quantity is our mandatory packing. Orders to be placed by Legrand (India) Stockist in multiples of the same.

Ekinox

Reinvent The New

Safety Styled for
Modern Spaces



MAKE A **SECOND** GLANCE

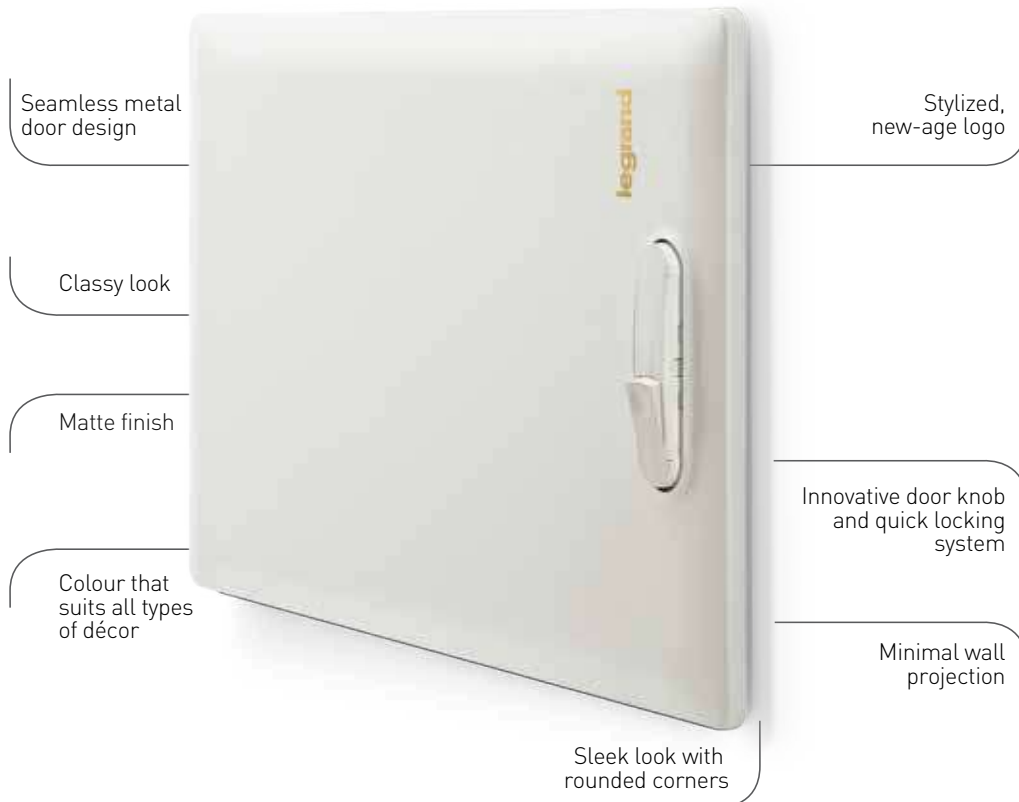

Scan to know more about the product.



Features and benefits

Maximum reliability & excellent safety-
Designed in accordance with IEC 61439-3



Integrated earthing system in order to avert risky contact



Completely insulated bus bars guarantee safety from severe shocks

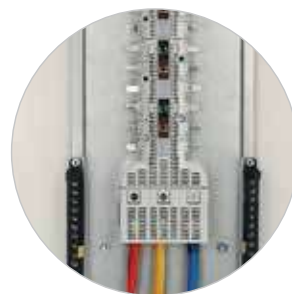

Shrouded neutral bars and insulated din rail for complete isolation



Reversible door can be easily removed



Normal lock convertible to key lock, so that it isn't tampered with



Colour-coded neutral bars for easy identification



Plastic plugs for mounting holes

Ekinox³™

Distribution Board

Built for Mivan Construction Environments



The Ekinox³ Mivan Compatible Distribution Board is designed to simplify electrical installations in modern Mivan construction projects. Its robust construction and compact form factor support reliable installation within concrete wall systems while maintaining a clean and minimal appearance for finished interiors.

Scan to know more about the product.



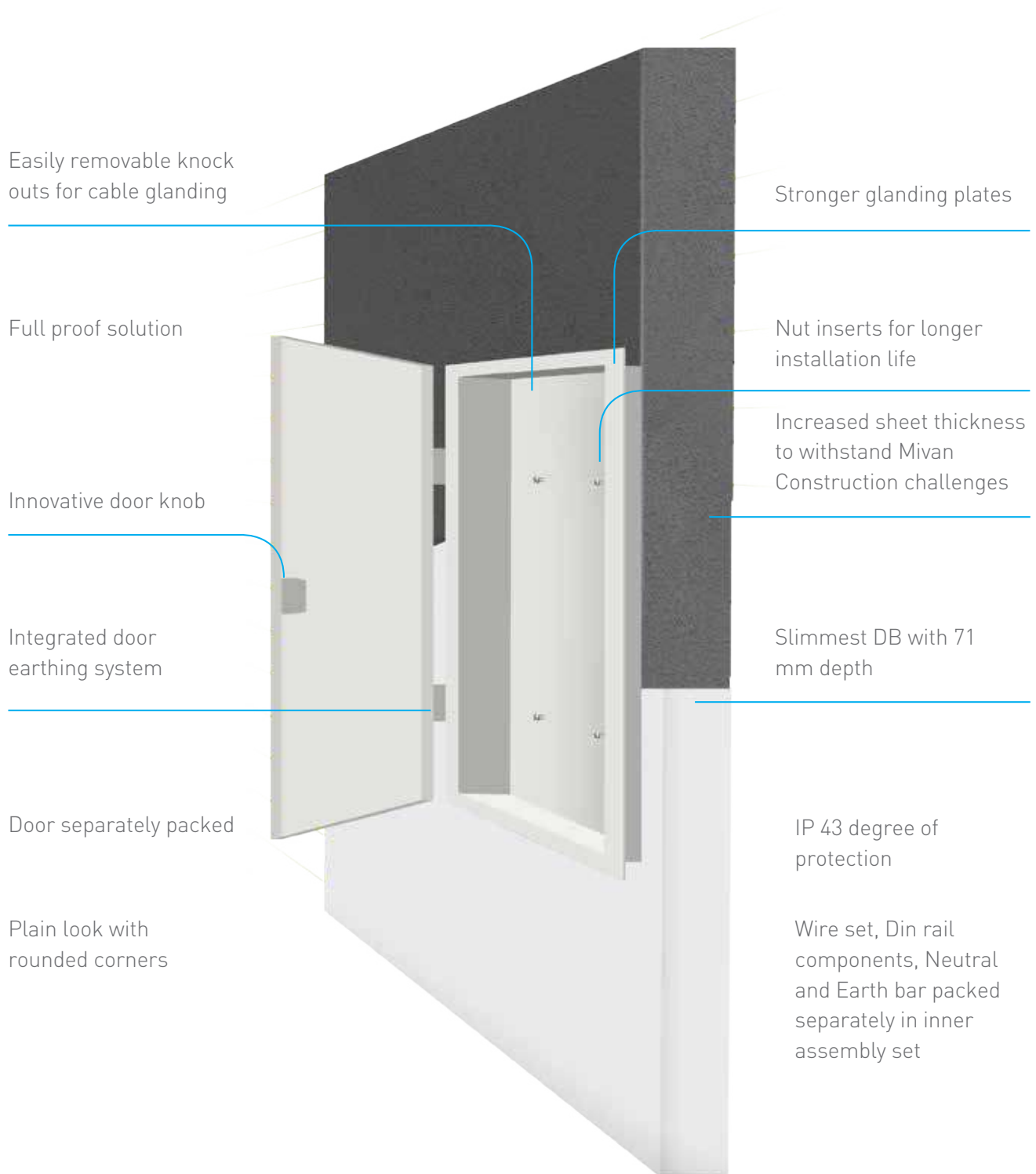

Ekinox³ SPN DB's

For DX³ MCB, Isolator, RCCB and RCBO

| Cat.Nos | Number ofWs | No. of modules | MRP* ₹ / Unit | Pack |
|---------|-------------|----------------|---------------|------|
|---------|-------------|----------------|---------------|------|

- As per IEC 61439-3
- Suitable for Flush Mounting and Surface Mounting
- With 100 A Copper Busbar
- With Neutral bar, Earthbar and Cable ties for Cable management
- Fully shrouded Neutral bars
- Prefitted masking sheet
- Reversible Door for IP 43 & IP 54 DB's

IP 30 - #IK 08

| | | | | |
|---------|-----|----|------|---|
| 5076 00 | 4W | 4 | 2128 | 1 |
| 5076 01 | 8W | 8 | 2581 | 1 |
| 5076 02 | 12W | 12 | 3050 | 1 |
| 5076 03 | 16W | 16 | 3726 | 1 |
| 5076 04 | 18W | 18 | 4334 | 1 |
| 5076 05 | 20W | 20 | 4834 | 1 |



5076 05



5076 12

IP 43 - #IK 09 with Metal Door

| | | | | |
|---------|-----|----|------|---|
| 5076 10 | 4W | 4 | 2788 | 1 |
| 5076 11 | 8W | 8 | 3597 | 1 |
| 5076 12 | 12W | 12 | 4322 | 1 |
| 5076 13 | 16W | 16 | 5415 | 1 |
| 5076 14 | 18W | 18 | 5690 | 1 |
| 5076 15 | 20W | 20 | 6573 | 1 |

IP 43 - #IK 09 with Acrylic Door

| | | | | |
|---------|-----|----|------|---|
| 5076 20 | 4W | 4 | 3726 | 1 |
| 5076 21 | 8W | 8 | 4316 | 1 |
| 5076 22 | 12W | 12 | 5245 | 1 |
| 5076 23 | 16W | 16 | 6514 | 1 |
| 5076 24 | 18W | 18 | 6815 | 1 |
| 5076 25 | 20W | 20 | 7216 | 1 |



5076 42

IP 54 - #IK 09

| | | | | |
|---------|-----|----|-------|---|
| 5076 40 | 4W | 4 | 9579 | 1 |
| 5076 41 | 8W | 8 | 11386 | 1 |
| 5076 42 | 12W | 12 | 13080 | 1 |
| 5076 43 | 16W | 16 | 14525 | 1 |
| 5076 44 | 18W | 18 | 14684 | 1 |
| 5076 45 | 20W | 20 | 15958 | 1 |

Ekinox³ ETPN DB's

For DX³ MCB, Isolator, RCCB and RCBO

- As per IEC 61439-3
- Suitable for Flush Mounting and Surface Mounting
- With 100 A Copper Busbar for each phase
- With Neutral bar, Earthbar and Cable ties for Cable management
- Fully insulated busbar & shrouded Neutral bars
- Improved Pan assembly for ease of installation
- Prefitted masking sheet
- Reversible Door for IP 43 & IP 54 DB's
- With provision for FP MCB/Isolator/RCCB/RCBO as incomer and SP MCB's as outgoing
- Supplied with wireset
- Can be converted to PPI DB at site using conversion kit

IP 30 - #IK 08

| | | | | |
|---------|-----|------|-------|---|
| 5076 60 | 4W | 8+12 | 6131 | 1 |
| 5076 61 | 6W | 8+18 | 7605 | 1 |
| 5076 62 | 8W | 8+24 | 8981 | 1 |
| 5076 63 | 12W | 8+36 | 12805 | 1 |
| 5076 64 | 16W | 8+48 | 15596 | 1 |
| 5076 66 | 20W | 8+60 | 21766 | 1 |



5076 61



5076 82



5077 01



5077 11

Ekinox³ ETPN DB's

For DX³ MCB, Isolator, RCCB and RCBO

| Cat.Nos | Number ofWs | No. of modules | MRP* ₹ / Unit | Pack |
|---------|-------------|----------------|---------------|------|
|---------|-------------|----------------|---------------|------|

IP 43 - #IK 09 with Metal Door

| | | | | |
|---------|-----|------|-------|---|
| 5076 70 | 4W | 8+12 | 7335 | 1 |
| 5076 71 | 6W | 8+18 | 8841 | 1 |
| 5076 72 | 8W | 8+24 | 10593 | 1 |
| 5076 73 | 12W | 8+36 | 15709 | 1 |
| 5076 74 | 16W | 8+48 | 19664 | 1 |
| 5076 76 | 20W | 8+60 | 27398 | 1 |

IP 43 - #IK 09 with Acrylic Door

| | | | | |
|---------|-----|------|-------|---|
| 5076 80 | 4W | 8+12 | 9237 | 1 |
| 5076 81 | 6W | 8+18 | 11292 | 1 |
| 5076 82 | 8W | 8+24 | 13289 | 1 |
| 5076 83 | 12W | 8+36 | 20584 | 1 |
| 5076 84 | 16W | 8+48 | 24787 | 1 |
| 5076 86 | 20W | 8+60 | 33509 | 1 |

IP 54 - #IK 09

| | | | | |
|---------|-----|------|-------|---|
| 5076 90 | 4W | 8+12 | 22966 | 1 |
| 5076 91 | 6W | 8+18 | 27636 | 1 |
| 5076 92 | 8W | 8+24 | 30224 | 1 |
| 5076 93 | 12W | 8+36 | 43009 | 1 |
| 5076 94 | 16W | 8+48 | 51114 | 1 |
| 5076 96 | 20W | 8+60 | 60809 | 1 |

Ekinox³ Flexy DB

For DX³ DIN Modular Products

| Cat.Nos | Number of row | No. of modules | MRP* ₹ / Unit | Pack |
|---------|---------------|----------------|---------------|------|
|---------|---------------|----------------|---------------|------|

- As per IEC 61439-3
- Suitable for Flush Mounting and Surface Mounting
- Completely flexible to organise the distribution as per site requirements
- Busbars to be selected as per distribution requirements
- With Neutral and Earth bars
- Fully shrouded Neutral bars
- Improved Pan assembly for ease of installation
- Prefitted masking sheet
- Reversible door for IP 43

IP 30 - #IK 08

| | | | | |
|---------|---------------|----|-------|---|
| 5077 01 | 2 row of 14 M | 28 | 7433 | 1 |
| 5077 02 | 3 row of 14 M | 42 | 9304 | 1 |
| 5077 03 | 4 row of 14 M | 56 | 10317 | 1 |

IP 43 - #IK 09 with Metal Door

| | | | | |
|---------|--|----|-------|---|
| 5077 05 | 2 row of 14 M | 28 | 9362 | 1 |
| 5077 06 | 3 row of 4 M | 42 | 11191 | 1 |
| 5077 07 | 4 row of 14 M | 56 | 12133 | 1 |
| 5077 14 | 4 row of 8 M | 32 | 10351 | 1 |
| 5077 15 | 4 row of 10 M | 40 | 10835 | 1 |
| 5077 12 | 3 row of 14 M MCCB for DPX ³ 160 MCCB | 42 | 12881 | 1 |

IP 43 - #IK 09 with Acrylic Door

| | | | | |
|---------|--|----|-------|---|
| 5077 09 | 2 row of 14 M | 28 | 9874 | 1 |
| 5077 10 | 3 row of 14 M | 42 | 12135 | 1 |
| 5077 11 | 4 row of 14 M | 56 | 13749 | 1 |
| 5077 13 | 3 row of 14 M MCCB for DPX ³ 160 MCCB | 42 | 14330 | 1 |

Bold Cat.Nos are products normally available with Legrand (India) Stockists. Cat.Nos that are not bold - delivery within 4 - 8 weeks from the date of order. Bold packing quantity is our mandatory packing. Orders to be placed by Legrand (India) Stockist in multiples of the same.

* MRP - Maximum Retail Price Inclusive of all taxes including GST.
#IK - Refer pg - 59 for ready reckoner table.

Ekinox³ TPN DB-VTPN DB's For DX³ MCB, Isolator, RCCB and RCBO

| Cat.Nos | Number of Ws | No. of modules | MRP* ₹ / Unit | Pack |
|---------|--------------|----------------|------------------|------|
|---------|--------------|----------------|------------------|------|

- As per IEC 61439-3
- Suitable for Flush Mounting and Surface Mounting
- With 100 A Copper Busbar for each phase
- With 2 Neutral bar, 2 Earthbar and Cable ties for Cable management
- Fully insulated busbar & shrouded Neutral bars
- Improved Pan assembly for ease of installation
- Prefitted masking sheet
- Reversible Door for IP 43 & IP 54 DB's
- With provision for FP MCB/Isolator/RCCB/RCBO as incomer and SP/TP MCB's as outgoing

IP 30 - #IK 08

| | | | | |
|---------|-----|------|-------|---|
| 5077 20 | 4W | 8+12 | 16452 | 1 |
| 5077 21 | 6W | 8+18 | 18055 | 1 |
| 5077 22 | 8W | 8+24 | 20084 | 1 |
| 5077 23 | 12W | 8+36 | 28998 | 1 |

IP 43 - #IK 09 with Metal Door

| | | | | |
|---------|-----|------|-------|---|
| 5077 25 | 4W | 8+12 | 17350 | 1 |
| 5077 26 | 6W | 8+18 | 19215 | 1 |
| 5077 27 | 8W | 8+24 | 22365 | 1 |
| 5077 28 | 12W | 8+36 | 30090 | 1 |

IP 43 - #IK 09 with Acrylic Door

| | | | | |
|---------|-----|------|-------|---|
| 5077 30 | 4W | 8+12 | 22512 | 1 |
| 5077 31 | 6W | 8+18 | 24770 | 1 |
| 5077 32 | 8W | 8+24 | 28964 | 1 |
| 5077 33 | 12W | 8+36 | 38641 | 1 |

IP 54 - #IK 09

| | | | | |
|---------|-----|------|-------|---|
| 5077 35 | 4W | 8+12 | 36085 | 1 |
| 5077 36 | 6W | 8+18 | 39236 | 1 |
| 5077 37 | 8W | 8+24 | 43403 | 1 |
| 5077 38 | 12W | 8+36 | 56188 | 1 |

Ekinox³ TPN DB-VTPN DPX³ 160 MCCB DB's

- As per IEC 61439-3
- Suitable for Flush Mounting and Surface Mounting
- With 250 A Copper Busbar for each phase
- With 2 Neutral bar, 2 Earthbar and Cable ties for Cable management
- Fully insulated busbar & shrouded Neutral bars
- Improved Pan assembly for ease of installation
- Prefitted masking sheet
- Reversible Door for IP 43 & IP 54 DB's
- With provision for DPX³ 160 MCCB as incomer and SP/TP MCB's as outgoing

IP 30 - #IK 08

| | | | | |
|---------|-----|-------------------------|-------|---|
| 5077 40 | 4W | DPX ³ 160+12 | 18457 | 1 |
| 5077 41 | 6W | DPX ³ 160+18 | 19741 | 1 |
| 5077 42 | 8W | DPX ³ 160+24 | 21497 | 1 |
| 5077 43 | 12W | DPX ³ 160+36 | 32562 | 1 |

* MRP - Maximum Retail Price Inclusive of all taxes including GST.
#IK - Refer pg - 59 for ready reckoner table.
■ Price available on request.

Ekinox³ TPN DB-VTPN DPX³ 160 MCCB DB's

| Cat.Nos | Number of Ws | No. of modules | MRP* ₹ / Unit | Pack |
|---------|--------------|----------------|------------------|------|
|---------|--------------|----------------|------------------|------|

IP 43 - #IK 09 with Metal Door

| | | | | |
|---------|-----|-------------------------|-------|---|
| 5077 45 | 4W | DPX ³ 160+12 | 21185 | 1 |
| 5077 46 | 6W | DPX ³ 160+18 | 24044 | 1 |
| 5077 47 | 8W | DPX ³ 160+24 | 26489 | 1 |
| 5077 48 | 12W | DPX ³ 160+36 | 36113 | 1 |

IP 54 - #IK 09

| | | | | |
|---------|-----|-------------------------|-------|---|
| 5077 50 | 4W | DPX ³ 160+12 | 42348 | 1 |
| 5077 51 | 6W | DPX ³ 160+18 | 48219 | 1 |
| 5077 52 | 8W | DPX ³ 160+24 | 52387 | 1 |
| 5077 53 | 12W | DPX ³ 160+36 | 69016 | 1 |

Ekinox³ TPN DB-VTPN DPX³ 250 MCCB DB's

- As per IEC 61439-3
- Suitable for Flush Mounting and Surface Mounting
- With 250 A Copper Busbar for each phase
- With 2 Neutral bar, 2 Earthbar and Cable ties for Cable management
- Fully insulated busbar & shrouded Neutral bars
- Improved Pan assembly for ease of installation
- Prefitted masking sheet
- Reversible Door for IP 43 & IP 54 DB's
- With provision for DPX³ 250 MCCB as incomer and SP/TP MCB's as outgoing

IP 30 - #IK 08

| | | | | |
|---------|-----|-------------------------|-------|---|
| 5077 55 | 4W | DPX ³ 250+12 | 29552 | 1 |
| 5077 56 | 8W | DPX ³ 250+24 | 31416 | 1 |
| 5077 57 | 12W | DPX ³ 250+36 | 34675 | 1 |

IP 43 - #IK 09 with Metal Door

| | | | | |
|---------|-----|-------------------------|-------|---|
| 5077 58 | 4W | DPX ³ 250+12 | 32495 | 1 |
| 5077 59 | 8W | DPX ³ 250+24 | 34268 | 1 |
| 5077 60 | 12W | DPX ³ 250+36 | 38723 | 1 |

IP 54 - #IK 09

| | | | | |
|---------|-----|-------------------------|-------|---|
| 5077 61 | 4W | DPX ³ 250+12 | 49957 | 1 |
| 5077 62 | 8W | DPX ³ 250+24 | 57090 | 1 |
| 5077 63 | 12W | DPX ³ 250+36 | 66715 | 1 |

Bold Cat.Nos are products normally available with Legrand (India) Stockists.
Cat.Nos that are not bold - delivery within 4 - 8 weeks from the date of order.
Bold packing quantity is our mandatory packing. Orders to be placed by Legrand (India) Stockist in multiples of the same.



5077 20



5077 31



5077 53



5077 55

Ekinox³ Mivan DB

| Cat.Nos | Number of Ws | No. of modules | MRP* ₹ / Unit | Pack |
|---------|--------------|----------------|------------------|------|
|---------|--------------|----------------|------------------|------|

Ekinox³ Mivan SPN DB

- As per IEC 61439-3
- Suitable for Mivan Construction
- With 100 A Copper Busbar
- With Neutral bar, Earthbar and Cable ties for Cable
- Fully shrouded Neutral bars
- Reversible Door

IP 43 - #IK 09 with Metal Door

| | | | | |
|----------|-----|----|------|---|
| 5076 10M | 4W | 4 | 3029 | 1 |
| 5076 11M | 8W | 8 | 3967 | 1 |
| 5076 12M | 12W | 12 | 4975 | 1 |
| 5076 13M | 16W | 16 | 6038 | 1 |
| 5076 15M | 20W | 20 | 7572 | 1 |



5076 12

Ekinox³ Mivan ETPN DB

- As per IEC 61439-3
- Suitable for Mivan Construction
- With 100 A Copper Busbar
- With Neutral bar, Earthbar and Cable ties for Cable
- Fully shrouded Neutral bars
- Reversible Door

IP 43 - #IK 09 with Metal Door

| Cat.Nos | Description | No. of modules | MRP* ₹ / Unit | Pack |
|----------|------------------------------|----------------|------------------|------|
| 5076 70M | 4W ETPN IP43 Mivan DB | 8+12 | 7234 | 1 |
| 5076 71M | 6W ETPN IP43 MIVAN DB | 8+18 | 9967 | 1 |
| 5076 72M | 8W ETPN IP43 MIVAN DB | 8+24 | 11957 | 1 |
| 5076 73M | 12W ETPN IP43 MIVAN DB | 8+36 | 17568 | 1 |

- * MRP - Maximum Retail Price Inclusive of all taxes including GST.
- Price available on request.

Ekinox³ PPI DB

| Cat.Nos | Description | MRP* ₹ / Unit |
|---------|-------------|------------------|
|---------|-------------|------------------|

| | | |
|----------|----------------------|---|
| 5076 70P | 4W ETPN IP43 PPI DB | ■ |
| 5076 71P | 6W ETPN IP43 PPI DB | ■ |
| 5076 72P | 8W ETPN IP43 PPI DB | ■ |
| 5076 73P | 12W ETPN IP43 PPI DB | ■ |
| 5076 74P | 16W ETPN IP43 PPI DB | ■ |
| 5076 76P | 20W ETPN IP43 PPI DB | ■ |

Bold Cat.Nos are products normally available with Legrand (India) Stockists. Cat.Nos that are not bold - delivery within 4 - 8 weeks from the date of order. Bold packing quantity is our mandatory packing. Orders to be placed by Legrand (India) Stockist in multiples of the same.

NEO

Distribution Boards

Sturdy & Robust Electrical Solution



Phase Selector Neo

Highly Compact

Sleek design

Easy to install –
4 way construction Separate Door,
Shield, Frame & Backbox

Integrated LED indication in the
selector switches

IP 43 protection

Robust Design
with - IK 09



8 Segment Neo DB

Compact

Sturdy & Robust design

Colour coded Neutral Bar's

Ease of Installation with
Detachable frame

8/7 compartments

Additional knockouts for
ease of wiring

Representative Wiring
Diagram on Door

IP42 & IK09



Scan to know more about
the product.

NEO DB

| Cat.Nos | Description | MRP* ₹ / Unit | Pack |
|---------|-------------|------------------|------|
|---------|-------------|------------------|------|

Phase Selector Neo DB

- As per IEC 61439-3
- Compact and sleek design
- IP 43 protection & IK 09
- Integrated LED indication in the selector switches
- With 100A copper busbar for each phase
- Fully insulated busbar & shrouded Neutral bars

| | | | |
|----------|---------|-------|---|
| 5077 80N | 4W NEO | 19049 | 1 |
| 5077 81N | 6W NEO | 19357 | 1 |
| 5077 82N | 8W NEO | 20737 | 1 |
| 5077 83N | 12W NEO | 23354 | 1 |



5077 81N

8 Segment Neo DB

IP 42 - #IK 09 with Metal Door

- As per IEC 61439-3
- DB with phase segmentation and separation between Incomer and Outgoings
- Sturdy & Robust design
- With 100A copper busbar for each phase
- Colour coded Neutral Bars
- Easy to Install : Detachable frame
- 8 compartments
- More number of knockouts
- IP42 & IK09
- Supplied with wire-set
- With provision for DPX³ 160 MCCB as incomer DP MCB/Isolator/RCCB/RCBO as sub incomers and SP MCB's as outgoing

| | | | |
|----------|-------------------|-------|---|
| 5078 85N | 4W 8/7S IP42 Neo | 14681 | 1 |
| 5078 86N | 6W 8/7S IP42 Neo | 16447 | 1 |
| 5078 87N | 8W 8/7S IP42 Neo | 18423 | 1 |
| 5078 88N | 12W 8/7S IP42 Neo | 22936 | 1 |



5078 86N

IP 42- #IK09 Suitable for 160A DPX³ MCCB as Incomer

| | | | |
|----------|-----------------------------|-------|---|
| 5078 95N | 4W 8/7S 160A MCCB IP42 Neo | 20380 | 1 |
| 5078 96N | 6W 8/7S 160A MCCB IP42 Neo | 23313 | 1 |
| 5078 97N | 8W 8/7S 160A MCCB IP42 Neo | 26942 | 1 |
| 5078 98N | 12W 8/7S 160A MCCB IP42 Neo | 30418 | 1 |

Ekinox³ Metal Enclosures for DX³ MCB, RCCB, RCBO and DPX³ MCCB's

- As per IEC 61439-3
- Suitable for Flush Mounting and Surface Mounting
- Suitable for protection of appliances like AC/Geyser etc
- Supplied with Neutral Links
- With provision for mounting modular devices

#IK 08

| | | | | |
|---------|--------------------|---|------|---|
| 5078 10 | 10 A SP, 2P+E | 1 | 2771 | 1 |
| 5078 11 | 20 A SP, 2P+E | 1 | 2985 | 1 |
| 5078 14 | 20 A DP, 2P+E | 2 | 3243 | 1 |
| 5078 17 | 20 A TP, 3P+E | 3 | 5494 | 1 |
| 5078 18 | 32 A TP, 3P+E | 3 | 6518 | 1 |
| 5078 20 | 20 A DP RCBO, 2P+E | 4 | 3137 | 1 |
| 5078 21 | 20 A FP RCBO, 2P+E | 8 | 5485 | 1 |
| 5078 22 | 32 A FP RCBO, 3P+E | 8 | 6466 | 1 |



5078 14



5078 22

* MRP - Maximum Retail Price Inclusive of all taxes including GST.
 # Price available on request.
 #IK - Refer pg - 59 for ready reckoner table.

Ekinox³ Metal Enclosures

| Cat.Nos | Description | No. of modules | MRP* ₹ / Unit | Pack |
|---------|-------------|----------------|------------------|------|
|---------|-------------|----------------|------------------|------|

- As per IEC 61439-3
- Suitable for Flush Mounting and Surface Mounting
- Supplied with Neutral Links
- With provision for mounting modular devices

#IK 08

| | | | | |
|---------|----------------|---|-------|---|
| 5078 60 | 16 A 2P+E-DP | 2 | 4525 | 1 |
| 5078 63 | 32 A 2P+E-DP | 2 | 4891 | 1 |
| 5078 61 | 32 A 3P+E-FP | 8 | 8188 | 1 |
| 5078 62 | 32 A 3P+N+E-FP | 8 | 8283 | 1 |
| 5078 64 | 63 A 3P+N+E-FP | 8 | 20618 | 1 |



5078 62



5078 64



5077 91



5077 93

Ekinox³ Metal Enclosures for DX³ MCB, RCCB, RCBO & DPX³ MCCB's

- As per IEC 61439-3
- For independent mounting of DX³ MCB, RCCB, RCBO, DPX³ 160, DPX³ 250, DPX³ 630 & DRX MCCB's
- #IK 08

#IK 08

| | | | | |
|---------|-------------------|---|------|---|
| 5077 90 | SP enclosure | 1 | 761 | 1 |
| 5077 91 | DP enclosure | 2 | 1097 | 1 |
| 5077 92 | TP enclosure | 3 | 1097 | 1 |
| 5077 93 | FP enclosure | 4 | 1097 | 1 |
| 5077 94 | FP RCBO enclosure | 8 | 1835 | 1 |

Metal One Way Enclosures for MCCB

| | | | | |
|---------|-------------------------------------|-----|-------|---|
| 5078 01 | DPX ³ 160 MCCB enclosure | 3&4 | 6242 | 1 |
| 5078 02 | DPX ³ 250 MCCB enclosure | 3&4 | 10976 | 1 |
| 5078 04 | DPX ³ 630 MCCB enclosure | 3&4 | 17050 | 1 |
| 5078 05 | DRX 100 MCCB enclosure-TP | 3 | 3370 | 1 |
| 5078 06 | DRX 100 MCCB enclosure-FP | 4 | 3370 | 1 |

Ekinox³ Cable End Box

- Useful for keeping extra cables
- Possible to mount on the top or bottom of the DB
- Provision for mounting terminal blocks
- Can be used as a terminal box adaptor also

For IP 30 DB's

| | | | |
|---------|----------------------------|------|---|
| 5079 10 | For SPN 4 W IP30 | 1111 | 1 |
| 5079 12 | For SPN 8 W IP30 | 1288 | 1 |
| 5079 14 | For SPN 12 W/ VTPN/Flexy | 1456 | 1 |
| 5079 16 | For SPN 16 W/ ETPN 6W DB | 2045 | 1 |
| 5079 25 | For ETPN 8W DB | 3673 | 1 |
| 5079 27 | For ETPN 12W DB | 4756 | 1 |
| 5079 29 | For ETPN 16W DB | 4850 | 1 |
| 5079 31 | For ETPN 18W DB | 5021 | 1 |
| 5079 33 | For ETPN 20W DB | 5198 | 1 |
| 5079 35 | For ETPN 4W VTPN/FLEXY MCB | 1442 | 1 |
| 5079 37 | For all VTPN MCCB DBS | 5313 | 1 |



5079 12

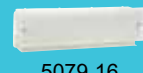

5079 16



5079 27

For IP 43 DB's

| | | | |
|---------|----------------------------|------|---|
| 5079 11 | For SPN 4W DB | 1272 | 1 |
| 5079 13 | For SPN 8W DB | 1553 | 1 |
| 5079 15 | For SPN 12W/ VTPN/Flexy DB | 1741 | 1 |

Bold Cat.Nos are products normally available with Legrand (India) Stockists. Cat.Nos that are not bold - delivery within 4 - 8 weeks from the date of order. Bold packing quantity is our mandatory packing. Orders to be placed by Legrand (India) Stockist in multiples of the same.

Ekinox³ Metal Enclosures

| Cat.Nos | Description | MRP* ₹ / Unit | Pack |
|---------|-------------|------------------|------|
|---------|-------------|------------------|------|

For IP 43 DB's

| | | | |
|---------|-----------------------------------|------|---|
| 5079 17 | For SPN 16W/ ETPN 6W DB | 2473 | 1 |
| 5079 18 | For SPN 18W DB | 2475 | 1 |
| 5079 19 | For SPN 20/ETPN 8W DB | 2585 | 1 |
| 5079 28 | For ETPN 12W DB | 5550 | 1 |
| 5079 30 | For ETPN 16W DB | 5656 | 1 |
| 5079 32 | For ETPN 18W DB | 5766 | 1 |
| 5079 34 | For ETPN 20W DB | 6100 | 1 |
| 5079 36 | For all ETPN 4W/VTPN/Flexy MCB | 1741 | 1 |
| 5079 38 | For all VTPN MCCB DBs | 6182 | 1 |

Ekinox³ DBs

Meter Box

- Suitable for Mounting DX³ Metering products
- Possible to mount on the top or bottom of the DB
- Provision for mounting Ammeter/Voltmeter/ASS/VSS
- #IK09

Provision for Mounting Meters

| | | | |
|---------|------------------------------|------|---|
| 5079 40 | For VTPN MCB INCOM IP 30 | 6847 | 1 |
| 5079 41 | For VTPN MCB INCOM IP 43 | 8402 | 1 |
| 5079 42 | For VTPN MCCB INCOM IP 30 | 7615 | 1 |
| 5079 43 | For VTPN MCCB INCOM IP 43 | 9697 | 1 |



5079 43

Per Phase Isolation Kit

| | | | |
|---------|---------------------------------------|------|---|
| 5079 44 | PPI conversion kit for ETPN 4W DB | 4294 | 1 |
| 5079 45 | PPI conversion kit for ETPN 6W DB | 4842 | 1 |
| 5079 46 | PPI conversion kit for ETPN 8W DB | 5520 | 1 |
| 5079 47 | PPI conversion kit for ETPN 12W DB | 6212 | 1 |
| 5079 48 | PPI conversion kit for ETPN 16W DB | 6946 | 1 |

Panel Locks

| | | | |
|---------|----------------------|-----|---|
| 5079 52 | Panel knob for IP 43 | 474 | 1 |
| 5079 51 | Panel knob with key | 989 | 1 |

Distribution Boards Accessories

| Cat.Nos | No. of devices connected | No. of 17.5 mm modules | MRP* ₹ / Unit | Pack |
|---------|--------------------------|------------------------|------------------|------|
|---------|--------------------------|------------------------|------------------|------|

Supply Busbars - Insulated

63 A Copper Pin Type

SP I/C & SP O/G

| | | | | |
|---------|----|----|------|---|
| 4049 26 | 13 | 13 | 515 | 1 |
| 4049 37 | 57 | 57 | 2001 | 1 |



- * MRP - Maximum Retail Price Inclusive of all taxes including GST.
- ▼ Compatible with Ekinox3 and NEO DB.
- #IK - Refer pg - 59 for ready reckoner table.

Distribution Boards

| Cat.Nos | Description | MRP* ₹ / Unit | Pack |
|---------|-------------|------------------|------|
|---------|-------------|------------------|------|

SPN I/C & SPN O/G

| | | | | |
|---------|----|----|------|---|
| 4049 46 | 6 | 12 | 904 | 1 |
| 4049 47 | 28 | 56 | 3740 | 1 |

TPN I/C & SPN O/G

| | | | | |
|---------|----|----|------|------|
| 4049 48 | 5 | 12 | 929 | 3/30 |
| 4049 50 | 27 | 56 | 9129 | 5/10 |

TP I/C & TP O/G

| | | | | |
|---------|----|----|------|---|
| 4049 51 | 4 | 12 | 936 | 1 |
| 4049 52 | 19 | 57 | 9177 | 1 |

FP I/C & FP O/G

| | | | | |
|---------|----|----|------|------|
| 4049 54 | 3 | 12 | 2254 | 3/30 |
| 4049 55 | 14 | 56 | 9129 | 5/10 |

Fork Type SP I/C & SP O/G

| | | | | |
|---------|----|----|------|---|
| 4049 56 | 13 | 12 | 515 | 1 |
| 4049 57 | 57 | 57 | 1964 | 1 |

SPN I/C & SPN O/G250

| | | | | |
|---------|----|----|------|---|
| 4049 59 | 28 | 56 | 3740 | 1 |
|---------|----|----|------|---|

TP I/C & TP O/G

| | | | | |
|---------|----|----|------|---|
| 4049 63 | 4 | 12 | 929 | 1 |
| 4049 64 | 19 | 57 | 4694 | 1 |

FP I/C & FP O/G

| | | | | |
|---------|----|----|------|------|
| 4049 36 | 14 | 56 | 9129 | 5/10 |
|---------|----|----|------|------|

Accessories for Fork and Pin Type Busbars

| Cat.Nos | No. of devices connected | No. of 17.5 mm modules | MRP* ₹ / Unit | Pack |
|---------|--------------------------|------------------------|------------------|------|
| 4049 89 | End caps for SP | 6 | 9 | 5/10 |



Blanking Plates

| Cat.Nos | Number of Ws | MRP* ₹ / Unit | Pack |
|---------|--------------|------------------|------|
| 6014 70 | - | 21 | 10 |



- Bold Cat.Nos are products normally available with Legrand (India) Stockists.
- Cat.Nos that are not bold - delivery within 4 - 8 weeks from the date of order.
- Bold packing quantity is our mandatory packing. Orders to be placed by Legrand (India) Stockist in multiples of the same.

Plexo³ Boxes for DX³

| Cat.Nos | Number ofWs | MRP* ₹ / Unit | Pack |
|--|-------------|------------------|------|
| Self-extinguishing: resistance to incandescent wire 650 °C Conform to EN 60439-3 Weatherproof cabinets - IP 65 - IK 09 - Class II Door and cabinet fully reversible Removable chassis and faceplates from 2-row versions up 2-position rail for modular products and moulded cases Spacing between rails 150 mm Box colour light grey L750A, cover colour dark grey R746A | | | |



6019 94

| | | | |
|---------|---------------|------|---|
| 6019 32 | 2 (+1) Module | 2581 | 1 |
| 6019 94 | 4 Module | 2790 | 1 |
| 6019 96 | 6 Module | 3186 | 1 |
| 6019 98 | 8 Module | 3981 | 1 |

Cabinets with 12 modules per row



6018 32

| | | | |
|---------|-------------------|-------|---|
| 6018 31 | 1 row 12 modules | 6270 | 1 |
| 6018 32 | 2 rows 24 modules | 8699 | 1 |
| 6018 33 | 3 rows 36 modules | 12123 | 1 |

Cabinets with 18 modules per row

| | | | |
|---------|---------------------|-------|---|
| 6018 35 | 18 modules x 1 row | 7733 | 1 |
| 6018 36 | 18 modules x 2 rows | 13381 | 1 |
| 6018 37 | 18 modules x 3 rows | 18814 | 1 |
| 6018 38 | 18 modules x 4 rows | 28159 | 1 |

Multifunction sleeves for P17



6018 32 +
0019 17

| | | | |
|---------|--------------------|------|---|
| 0019 17 | For 2 row cabinets | 4973 | 1 |
| 0019 18 | For 3 row cabinets | 7454 | 1 |
| 0019 67 | Joining kit | 1408 | 1 |

Plexo-S



6018 86

| | | | |
|---------|------------------------|------|---|
| 6018 82 | Waterproof cabinet 2M | 2063 | 1 |
| 6018 84 | Waterproof cabinet 4M | 2429 | 1 |
| 6018 86 | Waterproof cabinet 6M | 2792 | 1 |
| 6018 88 | Waterproof cabinet 8M | 3436 | 1 |
| 6018 92 | Waterproof cabinet 12M | 5511 | 1 |
| 6018 94 | Waterproof cabinet 24M | 7590 | 1 |



6018 94

* MRP - Maximum Retail Price Inclusive of all taxes including GST.
Refer instruction manual for MIVAN (Aluminum shuttering) compatible DB's
■ Price available on request.
Note: For Plexo3 Box with integrated Neutral & Earth Bars contact nearest Sales Office

Accessories

Fixing Lugs And Blanking Plates

| Cat.Nos | Number ofWs | MRP* ₹ / Unit | Pack |
|---------|--|------------------|------|
| 0019 69 | Set of 4 wall mounting lugs for Plexo, Plexo ³ cabinets and P 17 combined units | ■ | 1 |
| 0019 61 | 5, seperable into modules or 1/2 module Grey RAL 7046 | ■ | 20 |

Direct Piercing End Caps

| | | | |
|---------|--|---|---|
| 0019 56 | Pack consisting of 100 ø20 mm ISO and caps | ■ | 1 |
| 0019 57 | Pack consisting of 100 ø25 mm ISO and caps | ■ | 1 |

Earth Terminal & Neutral Terminal Blocks

Brass terminal block with isolated support conform to IEC 60998-2-1/2-2

| | | | |
|---------|--------------------------------|---|---|
| 1348 00 | 1 X (2x162 + 2x102); ICC : 6kA | ■ | 1 |
| 1348 01 | 1 X (3x162 + 3x102); ICC : 6kA | ■ | 1 |
| 1348 10 | 2 X (2x162 + 2x102); ICC : 6kA | ■ | 1 |
| 1348 11 | 2 X (3x162 + 3x102); ICC : 6kA | ■ | 1 |

Bold Cat.Nos are products normally available with Legrand (India) Stockists. Cat.Nos that are not bold - delivery within 4 - 8 weeks from the date of order. Bold packing quantity is our mandatory packing. Orders to be placed by Legrand (India) Stockist in multiples of the same.

PLEXO

Weatherproof Enclosures

The Go-To Range for Reliable Outdoor Installations



PLEXO enclosures deliver durable, weatherproof protection for modular electrical installations across indoor and outdoor environments. Featuring award-winning design, quick snap-fit assembly, and flexible configurations, they ensure faster installations and reliable performance in demanding site conditions.

Features

- Reversible modular design supporting 1–7 module configurations with transparent or opaque covers
- Tool-free snap-fit assembly for quick installation and flexible alignment
- High protection ratings with IP55–IP66 sealing and IK07–IK09 impact resistance
- Durable, eco-compliant materials with 650°C self-extinguishing capability

Benefits

- Reduces installation time with fast snap-fit mounting and flexible wiring space
- Performs reliably in harsh environments like garages, car parks, and wash areas
- Enables quick visual inspection using transparent protective covers
- Supports scalable installations with modular designs and smart-ready options



Scan to know more about the product.



Ekinox³ For Converting ETPN DB to PPI DB

PPI DB IP 30 - IK 08

| No. of ways | Combine | | No. of modules |
|-------------|------------------|----------------------|----------------|
| | ETPN DB | PPI Kit | |
| 4 way | 4 way 507660 | 4 way kit 507944 | 8+12 |
| 6 way | 6 way 507661 | 6 way kit 507945 | 8+18 |
| 8 way | 8 way 507662 | 8 way kit 507946 | 8+24 |
| 12 way | 12 way 507663 | 12 way kit 507947 | 8+36 |
| 16 way | 16 way 507664 | 16 way kit 507948 | 8+48 |

PPI DB IP 43 - IK 09 with metal door

| No. of ways | Combine | | No. of modules |
|-------------|------------------|----------------------|----------------|
| | ETPN DB | PPI Kit | |
| 4 way | 4 way 507670 | 4 way kit 507944 | 8+12 |
| 6 way | 6 way 507671 | 6 way kit 507945 | 8+18 |
| 8 way | 8 way 507672 | 8 way kit 507946 | 8+24 |
| 12 way | 12 way 507673 | 12 way kit 507947 | 8+36 |
| 16 way | 16 way 507674 | 16 way kit 507948 | 8+48 |

PPI DB IP 43 - IK 09 with acrylic door

| No. of ways | Combine | | No. of modules |
|-------------|------------------|----------------------|----------------|
| | ETPN DB | PPI Kit | |
| 4 way | 4 way 507680 | 4 way kit 507944 | 8+12 |
| 6 way | 6 way 507681 | 6 way kit 507945 | 8+18 |
| 8 way | 8 way 507682 | 8 way kit 507946 | 8+24 |
| 12 way | 12 way 507683 | 12 way kit 507947 | 8+36 |
| 16 way | 16 way 507684 | 16 way kit 507948 | 8+48 |

PPI DB IP 54 - IK 09

| No. of ways | Combine | | No. of modules |
|-------------|------------------|----------------------|----------------|
| | ETPN DB | PPI Kit | |
| 4 way | 4 way 507690 | 4 way kit 507944 | 8+12 |
| 6 way | 6 way 507691 | 6 way kit 507945 | 8+18 |
| 8 way | 8 way 507692 | 8 way kit 507946 | 8+24 |
| 12 way | 12 way 507693 | 12 way kit 507947 | 8+36 |
| 16 way | 16 way 507694 | 16 way kit 507948 | 8+48 |

IK

Protection against mechanical impact: protection index - IK

According to standard:

IEC 62262, BS EN 62262 and NF EN 62262

• This table can be used to ascertain the resistance of a product to an impact given in Joules from the IK code (graduated from 00 to 10)

It can also be used to ascertain the correspondence with the old IP code 3rd digit and the corresponding external "Ag" conditions

| IK | Tests | Impact energy (in Joules) | "AG" of NF C 15-100 |
|-------|-------|---------------------------|---------------------|
| IK 00 | | 0 | |
| IK 01 | | 0.15 | |
| IK 02 | | 0.2 | AG1 |
| IK 03 | | 0.35 | |
| IK 04 | | 0.5 | |
| IK 05 | | 0.7 | |
| IK 06 | | 1 | |
| IK 07 | | 2 | AG2 |
| IK 08 | | 5 | AG3 |
| IK 09 | | 10 | |
| IK 10 | | 20 | AG4 |

IPXX

Index of protection

IP*** index of protection of enclosures of electrical equipment in accordance with standards IEC 529, BS 5490, DIN 400 50 and NF C 20-010
Up to 1000 V± and 1500 V= (standard UTE C 20 010)

1st figure:- protection against solid bodies

| IP | tests | |
|----|-------|--|
| 0 | | No protection |
| 1 | | Protected against solid bodies larger than 50 mm (eg:- accidental contact with the hand) |
| 2 | | Protected against solid bodies larger than 12 mm (eg:- finger) |
| 3 | | Protected against solid bodies larger than 2.5 mm (eg:- tools, wires) |
| 4 | | Protected against solid bodies larger than 1 mm (eg:- fine tools and small wires) |
| 5 | | Protected against dust (no harmful deposit) |
| 6 | | Completely protected against dust |

2nd figure:- protection against liquids

| IP | tests | |
|----|-------|---|
| 0 | | No protection |
| 1 | | Protected against vertically-falling drops of water (condensation) |
| 2 | | Protected against drops of water falling at up to 15° from the vertical |
| 3 | | Protected against drops of rain water at up to 60° from the vertical |
| 4 | | Protected against projections of water from all directions |
| 5 | | Protected against jets of water from all directions |
| 6 | | Protected against jets of water of similar force to heavy seas |
| 7 | | Protected against the effects of immersion |
| 8 | | Protected against prolonged effects of immersion under pressure |

The contents of all the above charts are for guidance only, if you have any doubt as to the interpretation of the information contained therein, please refer either to the standard itself or contact Legrand.

In accordance with our policy of continuous improvement, Legrand reserves the right to change specifications and designs without notice. All information given here is correct at the time of going to press.

XCP-HP

Sandwich BBT

The High Performance Power Solution for Data Center Building & Industrial Application



XCP Sandwich Busbar Trunking is a compact power distribution system designed for high-current applications in large infrastructures such as skyscrapers, banks, data centers, and commercial buildings. Its sandwich construction enables efficient, safe, and reliable power distribution in space-constrained installations.

Features

- Wide current range from 630A to 6300A with copper and aluminium conductor options
- Designed for 50°C ambient condition
- Fire resistance up to 3 hours @830°C (IEC 60331-4) with high impact protection
- Halogen free
- Fully tested as per IEC 61439-6 standards
- Mechanical Impact tested IK10

Benefits

- Ensures safe and reliable power distribution in high-load buildings
- Optimises electrical riser and shaft space in large installations
- Minimises maintenance through durable, corrosion-resistant construction
- Supports faster project approvals with internationally compliant testing and performance standards

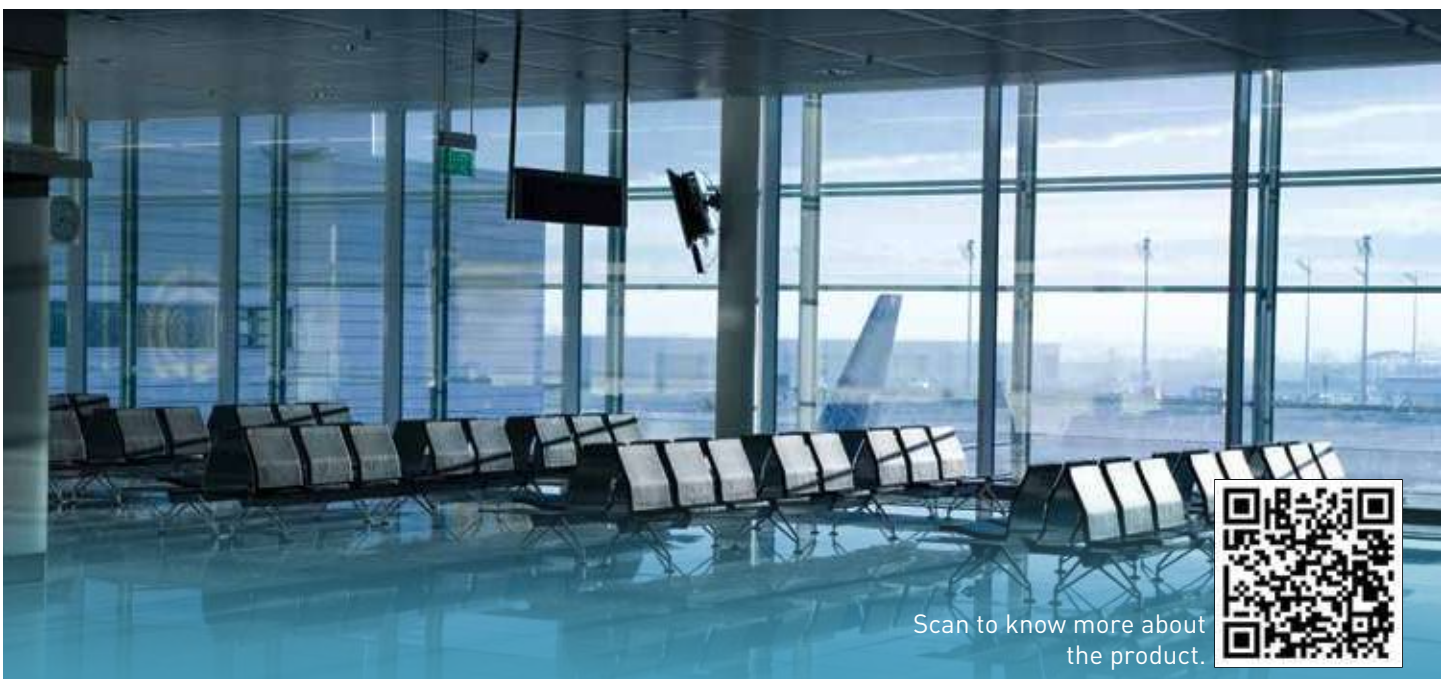

Scan to know more about the product.



ARTEOR™ ADVANCE

FEEL SOMETHING NEW

Premium Wiring Devices for Fine Living



Arteor™ Advance is a premium wiring device range designed for luxury residences, offices, and hospitality spaces. It combines refined aesthetics, innovative mechanisms, and smart connectivity to deliver elegant functionality for modern interiors.

Features

- Dual rocker styles with Classic and Elite designs
- Premium finish collections including Matt, Decor, Metal, and Statement full-metal plates
- Integrated plate adjuster for precise alignment on uneven walls
- Smart-ready features such as contactless switches, motion sensors, and hotel keycard controls

Benefits

- Elevates interior design with premium finishes and modern styling
- Supports connected living with integrated charging and smart control options
- Provides versatile solutions for residential, office, and hospitality spaces
- Ensures long-lasting performance with durable aluminium plates and refined build quality



Celebrating Design That Elevates Every Space



Scan to know more about
the product.



ARTEOR™
ADVANCE
FEEL SOMETHING NEW

Two Forms, One Design Concept

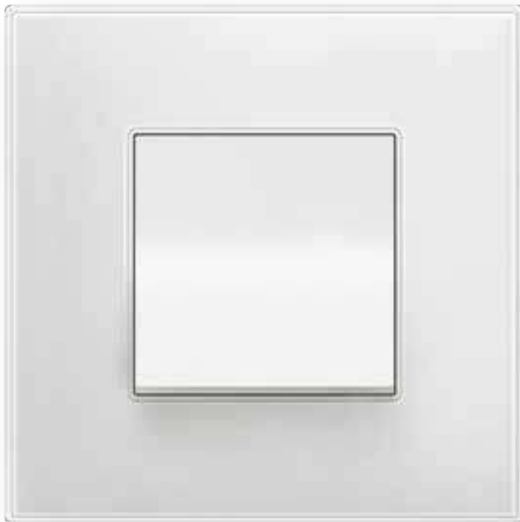

CLASSIC

Design language

Arteor Advance is available in two design lines, with clearly different rocker formats. The Classic design gives a whole new dimension to a classic form. The Elite rocker is a completely new design embodying the trends of the future.

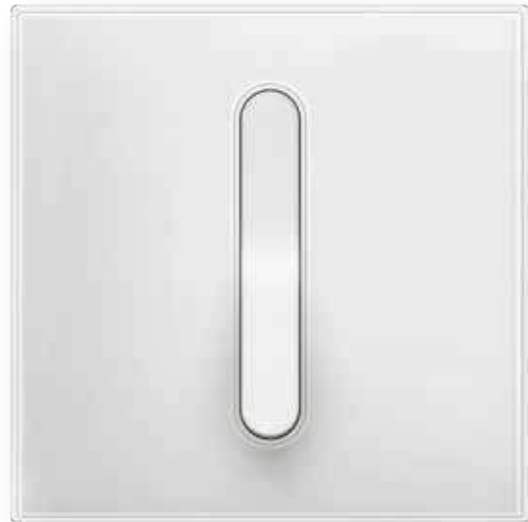

ELITE

Floating rocker

The impression created by the floating rocker is the same for both types: Light and elegant, it seems to float above the plate. Both forms can be combined to great effect as well. The Elite version allows you to make a clear statement, while the Classic version is more subtle and discreet.

FINISHES

Statement Collection
FULL METAL

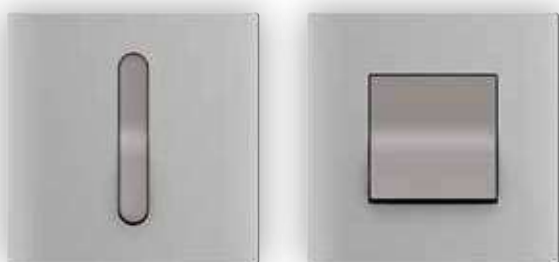

Decor Collection
FROSTED FINISHES



Classic Collection
BASIC NEUTRAL



Decor Collection
Metal Finishes

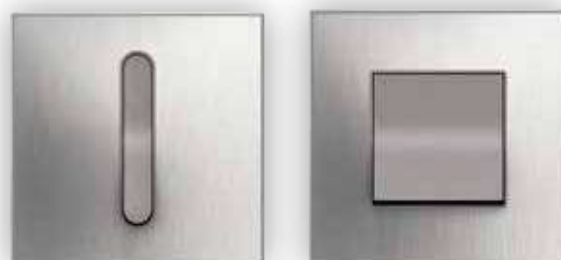

ARTEOR™ ADVANCE

FEEL SOMETHING NEW

Modular Design for Maximum Flexibility

The modular architecture of the range allows to integrate a wide range of different functions within a single plate, whatever the installation standard.



Even where space is scarce, individual configurations are possible.



Full modularity for maximum flexibility.

One Plate, Two Designs – Perfect Integration

Modularity is also maintained when you want to use both ergonomics, Classic and Elite in one plate. Thanks to special hybrid plates, both design lines can be combined in one plate at the same time, for more creative possibilities with a harmonious look.

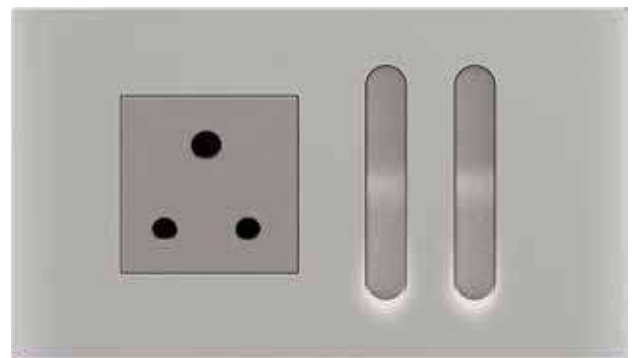

Switches in Elite design are easy to combine with socket outlets, dimmers, or USB chargers. Maximum flexibility for a wealth of combinations and a perfect look even when space is limited.

Pioneering a Sustainable Future with Bio-plastic Innovation



Innovation at Legrand goes beyond the product. Arteor Advance is our first range to feature packaging made with an innovative bio-plastic material. This pioneering eco-packaging solution is 90% biobased and is designed to lower carbon emissions by up to 70%. A conscious step towards a greener product lifecycle and a better future.

ARTEOR™ ADVANCE

FEEL SOMETHING NEW

Live As You Want

Everyone has their own ideas about how to arrange their living space, and people's individual preferences regarding the functionality of electrical equipment will vary widely too. With Arteor Advance, everyone can arrange their own private space accordingly and accommodate as much comfort or energy saving as they want. All in a premium consistent design.





Exploiting Every Potential

The new generation of LED dimmers and LED automatic switches are fully LED compatible and can also be used for all other types of modern loads. This makes it possible to exploit the full energy saving potential of LEDs, without losing out on convenience.



Switch with indicator

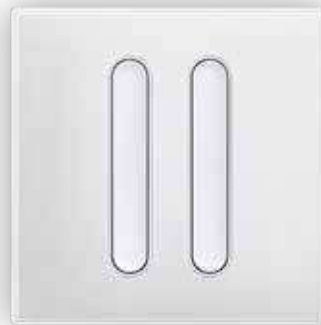

Smart 2-gang wireless batteryless light switch



Rotary fan controller



Double switch for electric shutter



USB Type C+C 30W PD Charger

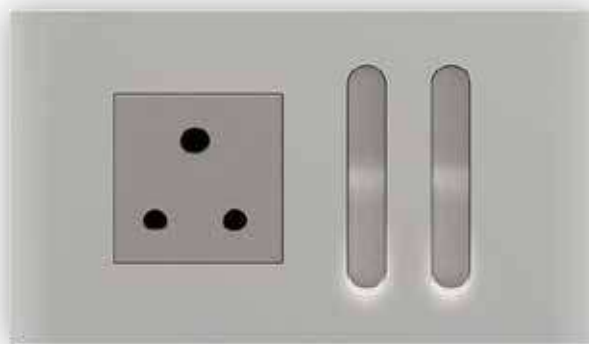

6A - 3 pin ISI Socket with 10A Elite Switch with Locator



TV-R-SAT sockets

Intelligent & Powerful: The New Usb Chargers

Arteor Advance meets the current USB-C standard with new chargers that integrate harmoniously into the design of the rest of the electrical installation. In addition to their design, they also impress with their performance; they are powerful enough to charge laptops. They also enable "fast charging" and protect the batteries of the connected devices with Power Delivery as they only supply as much power as is needed for charging. Available in 20W, 30W, 45W and 65W.

ARTEOR™ ADVANCE

FEEL SOMETHING NEW

Working with Arteor™ Advance

The boundaries between life and work are becoming increasingly blurred. That's why Arteor Advance offers solutions that make life and work both easier and more comfortable, while making optimal use of the possibilities offered by connectivity. The understated design improves both quality of life and productivity.

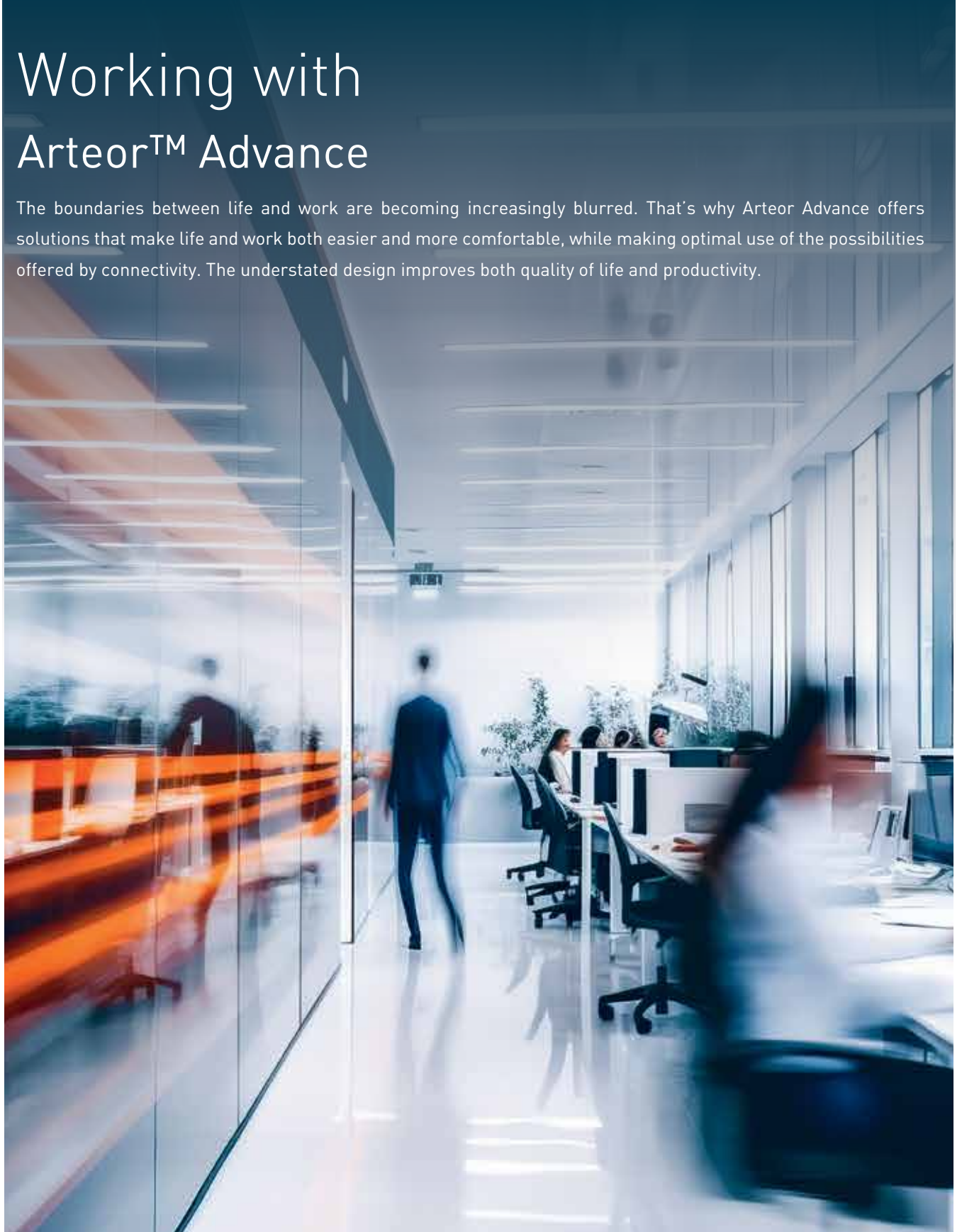



Arteor Advance mechanisms can be incorporated into Pop-Up boxes or Desk devices of the Incara range: seamless integration into furniture - power and data within easy reach.



All-in-one consistent design:

Power supply for all devices, data outlets and USB chargers with enough power for charging a laptop.



LED compatible motion sensors help to save energy as they only switch lights on when needed.

Contactless Switching

A new switch offers a more hygienic way of using lights and doors. It controls lights or opens doors without direct contact. Just position your hand close by, and the desired action will be triggered. In offices, hotels and anywhere lots of people use switches, the contactless switch is a valuable and convenient alternative to traditional solutions.



Contactless switch for control of lights or doors.

ARTEOR™
ADVANCE
FEEL SOMETHING NEW

Welcome to the
Arteor™ Advance Hotel

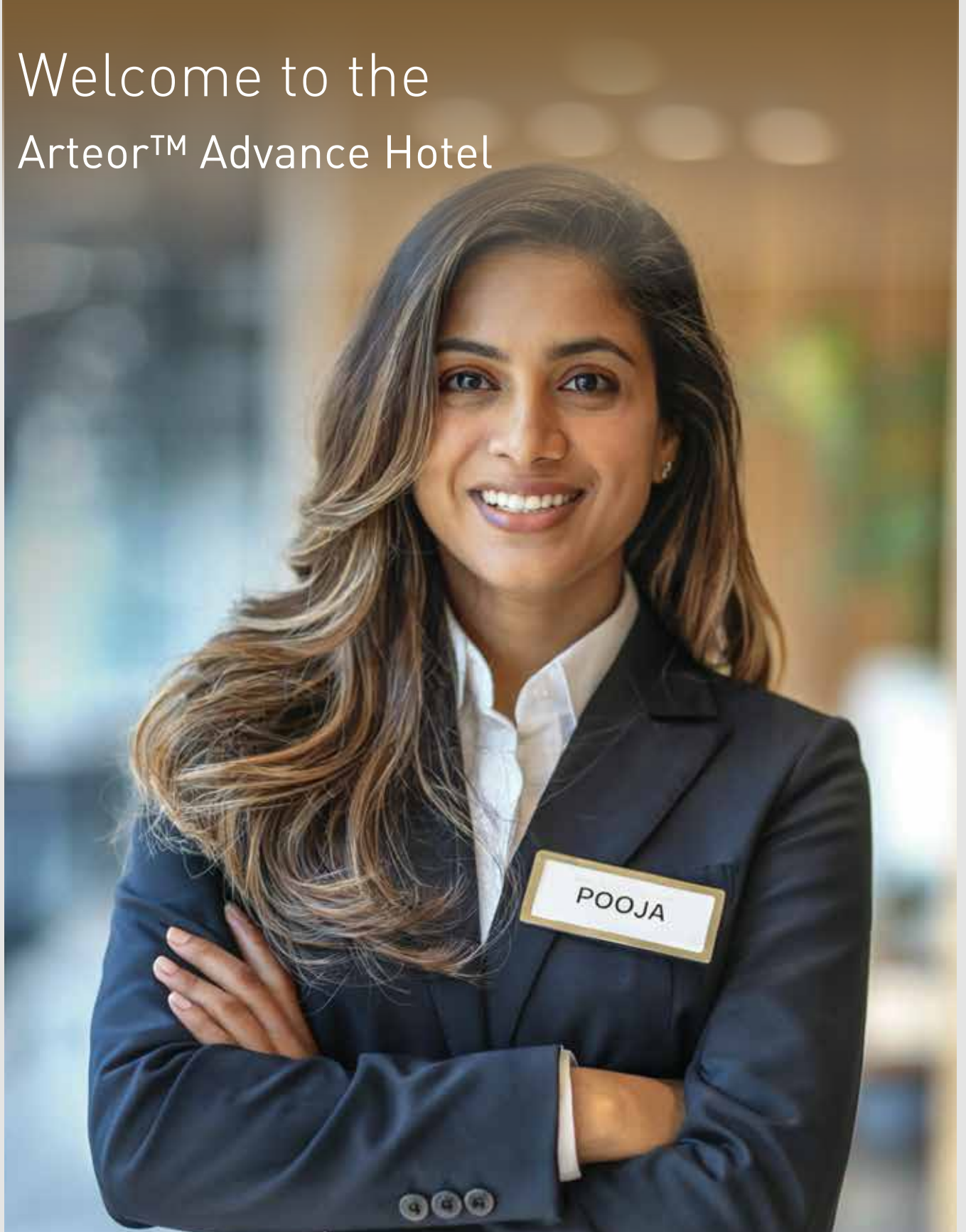



Key-Card Switch



Hotel room call indicator External unit: displays calls in the corridor.



Bedside panel: Dedicated markings allow for easy identification of the different functions: Master ON/OFF, control of bedlights, curtains, roller blinds, and more.

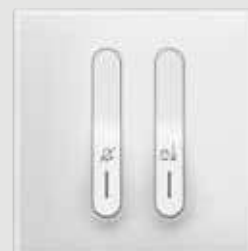

Internal unit: allows to select the desired setting "Do not disturb/ Make up room".

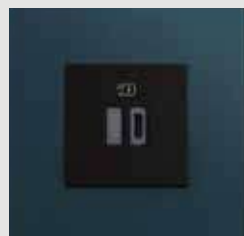

USB Type C 45W PD Charger



Double USB Type-C charger, 65 W, Fast charge feature: Power Delivery

















Shaver Socket

Lots of power with gentle fast charging

USB chargers are an essential feature, and not just for mobile working. They provide enough energy to charge laptops and other devices. The batteries are charged in a particularly resource-efficient manner by intelligently adjusting the charging current to the needs of the devices connected.

Arteor Advance™















NEW! Classic Matt White Mechanisms

| Cat.Nos | Description | MRP* ₹ / Unit | Pack |
|---|---|------------------|----------|
| Switches – 10A - 230V AC | | | |
|  AC21104MW | 10A - Switch - 1 Way - 1 Module | 264 | 1/20/200 |
|  AC21106MW | 10A - Switch - 1 Way - with Indicator - 1 Module | 488 | 1/20/200 |
|  AC21105MW | 10A - Switch - 1 Way - with Locator - 1 Module | 488 | 1/20/200 |
|  AC21102MW | 10A - Switch - 1 Way - with Locator (Blue) - 1 Module | 488 | 1/20/200 |
|  AC22105MW | 10A - Switch - 2 Way - 1 Module | 432 | 1/20/200 |
|  AC22107MW | 10A - Switch - 2 Way - with Indicator - 1 Module | 608 | 1/20/200 |
|  AC21119MW | 10A - Switch - 1 Way - with Indicator - 2 Module | 590 | 1/10/100 |
| Switches – 16A - 230V AC | | | |
|  AC21101MW | 16A - Switch - 1 Way - 1 Module | 442 | 1/20/200 |
|  AC21118MW | 16A - Switch - 1 Way - with Indicator - 1 Module | 562 | 1/20/200 |
|  AC22101MW | 16A - Switch - 2 Way - 1 Module | 690 | 1/20/200 |
|  AC22102MW | 16A - Switch - 2 Way - with Indicator - 1 Module | 700 | 1/20/200 |
|  AC21103MW | 16A - Switch - 1 Way - 2 Module | 590 | 1/10/100 |
|  AC20109MW | 16A - Intermediate Switch - 230V AC - 2 Module | 3444 | 1/10/100 |
|  AC22109MW | 16A - Switch - 2 Way - 2 Module | 970 | 1/10/100 |
| Switches – 20A - 230V AC | | | |
|  AC21107MW | 20A - Switch - 1 Way - 1 Module | 586 | 1/20/200 |
| AC21108MW | 20A - Switch - 1 Way - with Indicator - 1 Module | 664 | 1/20/200 |
| AC22106MW | 20A - Switch - 2 Way - 1 Module | 760 | 1/20/200 |
| AC22108MW | 20A - Switch - 2 Way - with Indicator - 1 Module | 846 | 1/20/200 |
| AC21112MW | 20A - Switch - 1 Way - 2 Module | 698 | 1/10/100 |
| AC22119MW | 20A - Switch - 2 Way - 2 Module | 828 | 1/10/100 |

* MRP - Maximum Retail Price Inclusive of all taxes including GST.
Red Cat. Nos - New Products

Arteor Advance™

NEW! Classic Matt White Mechanisms

| Cat.Nos | Description | MRP* ₹ / Unit | Pack |
|---|--|------------------|----------|
| Switches – 20A - 230V AC | | | |
|  AC22113MW | 20A - Switch - 2 Way - with Indicator - 2 Module | 918 | 1/10/100 |
|  AC21312MW | 20A - Switch - 3 Gang - 1 Way - 2 Module | 1652 | 1/10/100 |
|  AC29101MW | 20A - Switch - 3 Gang - 2X2 Way + 1X1 Way - 2 Module | 1810 | 1/10/100 |
|  AC21113MW | 20A - Switch - DP - 1 Way - with Indicator - 2 Module | 1302 | 1/10/100 |
|  AC20105MW | 20A - Switch - DP - 1 Way - with Indicator & Water Heater Marking - 2 Module | 1364 | 1/10/100 |
| Switches – 25A - 230V AC | | | |
|  AC21115MW | 25A - Switch - 1 Way - with Indicator - 1 Module | 786 | 1/20/200 |
| Switches – 32A - 230V AC | | | |
|  AC20101MW | 32A - Switch - DP - 1 Way - with Indicator - 2 Module | 1858 | 1/10/100 |
| Push Button – 10A - 230V AC | | | |
|  AC23102MW | 10A - Bell Push - 1 Way - 1 Module | 484 | 1/20/200 |
|  AC23103MW | 10A - Bell Push - 1 Way - with Locator - 1 Module | 642 | 1/20/200 |
|  AC23104MW | 10A - Bell Push - 1 Way - with Locator (Blue) - 1 Module | 642 | 1/20/200 |
|  AC23111MW | 10A - Bell Push - 1 Way - 2 Module | 682 | 1/10/100 |
|  AC23112MW | 10A - Bell Push - 1 Way - with Locator - 2 Module | 914 | 1/10/100 |
|  AC23121MW | 10A - Bell Push - 1 Way - with Locator (Blue) - 2 Module | 914 | 1/10/100 |
|  AC23106MW | 10A - Push Button - 1 Way - 1 Module | 512 | 1/20/200 |
|  AC23107MW | 10A - Push Button - 1 Way - with Locator - 1 Module | 648 | 1/20/200 |
| AC23120MW | 10A - Push Button - 1 Way - with Locator (Blue) - 1 Module | 648 | 1/20/200 |
| AC23108MW | 10A - Push Button - 2 Way - 1 Module | 714 | 1/10/100 |

Bold Cat.Nos are products normally available with Legrand (India) Stockists. Cat.Nos that are not bold - delivery within 4 - 8 weeks from the date of order. Bold packing quantity is our mandatory packing. Orders to be placed by Legrand (India) Stockist in multiples of the same.

Arteor Advance™

NEW! Classic Matt White Mechanisms

| Cat.Nos | Description | MRP* ₹ / Unit | Pack |
|--|--------------------------------------|------------------|--------|
| Accessories for Classic and Elite Switches with Locator and Indicator | | | |
| A180 | Red LED for Indicator 230 V | 108 | 10/100 |
| A186 | Blue LED for Locator 230 V | 108 | 10/100 |
| A187 | Warm white LED for Locator 230 V 0.8 | 108 | 10/100 |
| A188 | Warm white LED for Locator 230 V 0.3 | 108 | 10/100 |



Electric Roller Blinds

| | | | |
|------------------|---|------|----------|
| AC26104MW | Double Switch for Electric Shutter - 2 Module | 1184 | 1/10/100 |
|------------------|---|------|----------|

Dimmers and Fan Regulators

| | | | |
|------------------|--|-------|----------|
| AC24103MW | Light Dimmer - 60 to 400 Watts - 2 Module | 1996 | 1/10/100 |
| AC24105MW | Push Dimmer 0-10V - 2 Module | 12810 | 1/20 |
| AC24101MW | Push Dimmer 150W With Neutral - 1 Module | 18302 | 1/5/20 |
| AC24104MW | Push Dimmer 125W Without Neutral - 2 Module | 11896 | 1/20 |
| AC24106MW | Touch Dimmer 5-300W/75W - 2 Module | 10980 | 1/20 |
| AC24107MW | Rotary Dimmer 200W LED - 2 Module | 20132 | 1/10 |
| AC661MW | Fan Step Regulator - 100 Watts - ISI - 1 Module | 1604 | 1/5/50 |
| AC662MW | Fan Step Regulator - 100 Watts - ISI - 2 Module | 1980 | 1/10/100 |
| AC665MW | Fan Step Regulator - 70 Watts - ISI - 2 Module | 2110 | 1/10/100 |
| AC663MW | Fan Step Regulator - 120 Watts - ISI - 2 Module | 2118 | 1/10/100 |
| AC664MW | Fan Regulator - 8 Steps - 100 Watts - ISI - 2 Module | 1886 | 1/10/100 |



Arteor Advance™

NEW! Classic Matt White Mechanisms

| Cat.Nos | Description | MRP* ₹ / Unit | Pack |
|--------------------------------|---|------------------|----------|
| Indian Standard Sockets | | | |
| AC3163MW | 6A - Socket - with Shutter - 3 Pin - ISI - 2 Module | 404 | 1/20/200 |
| AC3166MW | 6/16A - Socket - with Shutter - 3 Pin - Indian - ISI - 2 Module | 818 | 1/10/100 |
| AC3167MW | 6/16A - Socket - with Shutter - 3 Pin - Indian - ISI - 3 Module | 980 | 1/5/50 |



Energy Plugs

| | | | |
|----------------|------------|-----|--------|
| AC100MW | 6A - Plug | 192 | 10/100 |
| AC101MW | 16A - Plug | 256 | 10/100 |



USB Chargers

| | | | |
|-----------------|---|-------|----------|
| AC3408MW | USB Charger - 3000mA/15 Watts - Type A - 1 Module | 3668 | 1/10/150 |
| AC3410MW | USB Charger - 3000mA/15 Watts - Type A + A - 1 Module | 4150 | 1/10/150 |
| AC3411MW | USB Charger - 3000mA/15 Watts - Type A + C - 1 Module | 4626 | 1/10/150 |
| AC3412MW | USB Charger - 3000mA/15 Watts - Type C + C - 1 Module | 5178 | 1/10/150 |
| AC3409MW | USB Charger - Power Delivery - 20 Watts - Type C - 1 Module | 7090 | 1/10/150 |
| AC3406MW | USB Charger - Power Delivery - 30 Watts - Type C + C - 2 Module | 10610 | 1/20 |
| AC3401MW | USB Charger - Power Delivery - 45 Watts - Type C - 2 Module | 13690 | 1/20 |
| AC3415MW | USB Charger - Power Delivery - 65 Watts - Type C + C - 3 Module | 16766 | 1/20 |



Data and Voice

| | | | |
|-----------------|--|------|----------|
| AC423MW | Telephone Socket - Double RJ11 - 1 Module | 746 | 1/20/200 |
| AC424MW | Telephone Socket - RJ11 - with Shutter - 1 Module | 434 | 1/20/200 |
| AC4306MW | Information Socket - RJ45 - Cat 6A - UTP - 1 Module | 1946 | 10/100 |
| AC4315MW | Information Socket - RJ45 Rear Pluggable - CAT6 - UTP - 2 Module | 5356 | 1/10/100 |



TV Sockets

| | | | |
|-----------------|---------------------------------|-----|----------|
| AC4110MW | TV Co - axial Socket - 1 Module | 446 | 1/20/200 |
|-----------------|---------------------------------|-----|----------|



* MRP - Maximum Retail Price Inclusive of all taxes including GST.
Red Cat. Nos - New Products

Bold Cat.Nos are products normally available with Legrand (India) Stockists. Cat.Nos that are not bold - delivery within 4 - 8 weeks from the date of order. Bold packing quantity is our mandatory packing. Orders to be placed by Legrand (India) Stockist in multiples of the same.

Arteor Advance™

NEW! Classic Matt White Mechanisms

| Cat.Nos | Description | MRP* ₹ / Unit | Pack |
|---------|-------------|------------------|------|
|---------|-------------|------------------|------|

Electronic Chime

| | | | |
|----------------|----------------------------------|-----|----------|
| AC618MW | Bell Ding Dong - 230V - 2 Module | 800 | 1/10/100 |
|----------------|----------------------------------|-----|----------|

Buzzer

| | | | |
|----------------|--------------------------|------|-------|
| AC615MW | Buzzer - 230V - 1 Module | 2114 | 10/60 |
|----------------|--------------------------|------|-------|

Bell Call Indicator

| | | | |
|------------------|--------------------------------|------|----------|
| AC23105MW | Bell Call Indicator - 1 Module | 3070 | 1/20/200 |
|------------------|--------------------------------|------|----------|

Infrared Sensors

| | | | |
|------------------|--|-------|------|
| AC25102MW | IR Motion Sensor with Neutral - 2 Module | 12920 | 1/20 |
|------------------|--|-------|------|

Innovative Switch

| | | | |
|------------------|---|------|------|
| AC28102MW | Contactless Door Switch - 12-24-48 V - 2 Module | 7466 | 1/20 |
| AC28101MW | Contactless Light Switch - 230V AC - 2 Module | 6718 | 1/20 |

Skirting Light

| | | | |
|----------------|--|-------|--------|
| AC653MW | Skirting Light - with LED - 230V - 3 Module | 1648 | 10/100 |
| AC652 | Removable Plug-in Skirting Light - 230V - 2 Module | 25012 | 1/12 |

Lighting

| | | | |
|--------------|---|------|--------|
| AC654 | Over Door Light Unit White/Red/Green/Blue - 2 Module | 762 | 1/50 |
| AC655 | Indicator Unit - with transparent & Colored Labels- 1 Module | 1234 | 10/100 |
| AC656 | Illuminated Light unit with 4 LED colours (white/red/green/blue) - 2 Module | 1360 | 5/50 |

Hospitality Function

Hotel "DND and MMR" functions

| | | | |
|------------------|---|------|----------|
| AC27107MW | Interlocked Internal DND & MMR Control Unit - 2 Module | 2364 | 1/10/100 |
| AC27108MW | External DND & MMR Control Unit - with Bell Push - 2 Module | 3298 | 1/5/50 |

Hotel Keycard Switch

| | | | |
|------------------|---|------|------|
| AC27110MW | 16A - Key Card Switch - 230V - 2 Module | 9000 | 1/20 |
| AC27111MW | 16A - Key Card Switch with RFID - 230V - 2 Module | 9388 | 1/20 |
| 679255 | Key Fob for Key Card Switch White | 234 | - |

Arteor Advance™

NEW! Hospitality Funtion

| Cat.Nos | Description | MRP* ₹ / Unit | Pack |
|---------|-------------|------------------|------|
|---------|-------------|------------------|------|

Hotel Keycard Switch

| | | | |
|---------------|----------------------------------|------|--------|
| 076711 | Key Fob for RFID Key Card Switch | 2698 | 10/200 |
|---------------|----------------------------------|------|--------|

Shaver Socket

| | | | |
|----------------|--|------|------|
| AC361MW | Shaver Socket - 230V/120 - 230V - with Earth Connector | 9354 | 1/10 |
|----------------|--|------|------|

Time Switch

| | | | |
|------------------|------------------------------|-------|------|
| AC20110MW | Time Delay Switch - 2 Module | 11044 | 1/20 |
|------------------|------------------------------|-------|------|

Master Switch

| | | | |
|------------------|--|-----|----------|
| AC22114MW | 20A - Master Switch - DP - 2 Way - ON/OFF - 2 Module | 812 | 1/10/100 |
| AC23115MW | Master Push ON/OFF - 2 Way - 2 Module | 794 | 1/10/100 |

Bedlight Switch

| | | | |
|------------------|--|-----|--------|
| AC21117MW | 10A - Bedlight Switch - 2 Way - 2X1 - 2 Module | 778 | 1/5/50 |
| AC23119MW | 10A - Push for Bedlight - 2 Way - 2X1 - 2 Module | 778 | 1/5/50 |

Reading Light

| | | | |
|----------------|------------------------------|------|------|
| AC657MW | Reading Light LED - 2 Module | 4188 | 1/12 |
|----------------|------------------------------|------|------|

Protectors & Accessories

| Cat.Nos | Description | MRP* ₹ / Unit | Pack |
|---------|-------------|------------------|------|
|---------|-------------|------------------|------|

Surge Protector

| | | | |
|----------------|----------------------------|------|--------|
| AC627MW | Surge Protector - 1 Module | 6692 | 20/200 |
|----------------|----------------------------|------|--------|

Motor Starter

| | | | |
|------------------|--------------------------------|------|----------|
| AC20111MW | 16A - Motor Starter - 2 Module | 1332 | 1/10/100 |
| AC20112MW | 25A - Motor Starter - 2 Module | 1368 | 1/10/100 |

Modular MCB

| | | | |
|----------------|---|-----|--------|
| AC628MW | 16A - SP - Modular MCB - C Curve - 1 Module | 796 | 1/5/50 |
|----------------|---|-----|--------|

* MRP - Maximum Retail Price Inclusive of all taxes including GST.
Red Cat. Nos - New Products

Bold Cat.Nos are products normally available with Legrand (India) Stockists. Cat.Nos that are not bold - delivery within 4 - 8 weeks from the date of order. Bold packing quantity is our mandatory packing. Orders to be placed by Legrand (India) Stockist in multiples of the same.

Arteor Advance™

NEW! Protectors & Accessories

| Cat.Nos | Description | MRP* ₹ / Unit | Pack |
|--------------------|---|------------------|--------|
| Modular MCB | | | |
| AC625MW | 20A - SP - Modular MCB - C Curve - 1 Module | 796 | 1/5/50 |
| AC626MW | 32A - SP - Modular MCB - C Curve - 1 Module | 796 | 1/5/50 |



AC626MW

Audio-Video Sockets

| | | | |
|-----------------|--|-------|----------|
| AC4430MW | Female 3.5mm Jack - 1 Module | 6684 | 1/10 |
| AC4421MW | Preterminated Sockets Female Hd15 - 1 Module | 9306 | 1/10 |
| AC4411MW | Preterminated HDMI Socket - 1.4 - 1 Module | 11044 | 1/10 |
| AC4400MW | Loudspeaker Socket - 1 Module | 1180 | 1/10/100 |
| AC4452MW | Male XLR Jack - 2 Module | 9484 | 1/20 |
| AC4412MW | Preterminated HDMI Socket - 1.4 - 2 Module | 11598 | 1/10 |
| AC4106MW | TV-R-SAT Socket - 2 Module | 5706 | 1/0/10 |
| AC4442MW | Triple RCA Socket (Audio & Video) - 1 Module | 6022 | 1/20 |
| AC4362MW | Preterminated USB Data Socket - 1 Module | 8322 | 1/10 |
| AC4360MW | USB Socket - 1 Module | 5268 | 2/0/20 |
| AC4470MW | Line Dying Down - 100V (25 - 30W) - 2 Module | 17522 | 1/20 |
| AC4450MW | Female XLR Jack - 2 Module | 10516 | 1/20 |
| AC4440MW | 2 Female RCA Socket - 1 Module | 4888 | 1/10 |



AC4430MW



AC4411MW



AC4400MW



AC4452MW



AC4362MW



AC4470MW



AC4450MW

Arteor Advance™

NEW! Protectors & Accessories

| Cat.Nos | Description | MRP* ₹ / Unit | Pack |
|---------------------|--|------------------|--------|
| Cable Outlet | | | |
| AC350MW | 20A - Cable Outlet - 2 Module | 1810 | 10/100 |
| AC354MW | Cord Outlet - with 8mm Diameter - 1 Module | 576 | 20/200 |



AC350MW

Blanking Plate

| | | | |
|----------------|---------------------------|-----|----------|
| AC150MW | Blanking Plate - 1 Module | 82 | 1/40/400 |
| AC153MW | Blanking Plate - 2 Module | 122 | 1/10/100 |



AC153MW

Mounting Accessories for Panel

| | | | |
|--------------|-----------------------------------|-----|--------|
| A1401 | Panel Mounting Support - 2 Module | 500 | 10/100 |
|--------------|-----------------------------------|-----|--------|



A1401

Classic - Matt Black Mechanisms

| Cat.Nos | Description | MRP* ₹ / Unit | Pack |
|---------|-------------|------------------|------|
|---------|-------------|------------------|------|

Switches - 10A - 230V AC

| | | | |
|------------------|--|-----|----------|
| AC21104MB | 10A - Switch - 1 Way - 1 Module | 306 | 1/20/200 |
| AC21106MB | 10A - Switch - 1 Way - with Indicator - 1 Module | 558 | 1/20/200 |
| AC21105MB | 10A - Switch - 1 Way - with Locator - 1 Module | 558 | 1/20/200 |
| AC22105MB | 10A - Switch - 2 Way - 1 Module | 500 | 1/20/200 |
| AC22107MB | 10A - Switch - 2 Way - with Indicator - 1 Module | 714 | 1/20/200 |
| AC21119MB | 10A - Switch - 1 Way - with Indicator - 2 Module | 632 | 1/10/100 |



AC21104MB



AC22105MB



AC21119MB

Switches - 16A - 230V AC

| | | | |
|------------------|--|------|----------|
| AC21101MB | 16A - Switch - 1 Way - 1 Module | 512 | 1/20/200 |
| AC21118MB | 16A - Switch - 1 Way - with Indicator - 1 Module | 640 | 1/20/200 |
| AC22101MB | 16A - Switch - 2 Way - 1 Module | 800 | 1/20/200 |
| AC22102MB | 16A - Switch - 2 Way - with Indicator - 1 Module | 818 | 1/20/200 |
| AC21103MB | 16A - Switch - 1 Way - 2 Module | 632 | 1/10/100 |
| AC20109MB | 16A - Intermediate Switch - 230V AC - 2 Module | 3970 | 10/100 |
| AC22109MB | 16A - Switch - 2 Way - 2 Module | 1036 | 1/10/100 |



AC21101MB



AC22102MB



AC22109MB

* MRP - Maximum Retail Price Inclusive of all taxes including GST.
Red Cat. Nos - New Products

Bold Cat.Nos are products normally available with Legrand (India) Stockists. Cat.Nos that are not bold - delivery within 4 - 8 weeks from the date of order. Bold packing quantity is our mandatory packing. Orders to be placed by Legrand (India) Stockist in multiples of the same.

Arteor Advance™

NEW! Classic - Matt Black Mechanisms

| Cat.Nos | Description | MRP* ₹ / Unit | Pack |
|---------------------------------|--|------------------|----------|
| Switches – 20A - 230V AC | | | |
| AC21107MB | 20A - Switch - 1 Way - 1 Module | 664 | 1/20/200 |
| AC21108MB | 20A - Switch - 1 Way - with Indicator - 1 Module | 768 | 1/20/200 |
| AC22106MB | 20A - Switch - 2 Way - 1 Module | 862 | 1/20/200 |
| AC22108MB | 20A - Switch - 2 Way - with Indicator - 1 Module | 958 | 1/20/200 |
| AC21112MB | 20A - Switch - 1 Way - 2 Module | 784 | 1/10/100 |
| AC22119MB | 20A - Switch - 2 Way - 2 Module | 924 | 1/10/100 |
| AC22113MB | 20A - Switch - SP - 2 Way - with Indicator - 2 Module | 1030 | 1/10/100 |
| AC21312MB | 20A - Switch - 3 Gang - 1 Way - 2 Module | 1894 | 1/10/100 |
| AC29101MB | 20A - Switch - 3 Gang - 2X2 Way + 1X1 Way - 2 Module | 1984 | 1/10/100 |
| AC21113MB | 20A - Switch - DP - 1 Way - with Indicator - 2 Module | 1534 | 1/10/100 |
| AC20105MB | 20A - Switch - DP - 1 Way - with Indicator & Water Heater Marking - 2 Module | 1640 | 1/10/100 |

Switches – 25A - 230V AC

| | | | |
|------------------|--|-----|----------|
| AC21115MB | 25A - Switch - 1 Way - with Indicator - 1 Module | 880 | 1/20/200 |
|------------------|--|-----|----------|

Switches – 32A - 230V AC

| | | | |
|------------------|---|------|----------|
| AC20101MB | 32A - Switch - DP - 1 Way - with Indicator - 2 Module | 2140 | 1/10/100 |
|------------------|---|------|----------|

Push Button – 10A - 230V AC

| | | | |
|------------------|---|-----|----------|
| AC23102MB | 10A - Bell Push - 1 Way - 1 Module | 544 | 1/20/200 |
| AC23103MB | 10A - Bell Push - 1 Way - with Locator - 1 Module | 752 | 1/20/200 |

Arteor Advance™

NEW! Classic - Matt Black Mechanisms

| Cat.Nos | Description | MRP* ₹ / Unit | Pack |
|------------------------------------|---|------------------|----------|
| Push Button – 10A - 230V AC | | | |
| AC23111MB | 10A - Bell Push - 1 Way - 2 Module | 778 | 1/10/100 |
| AC23112MB | 10A - Bell Push - 1 Way - with Locator - 2 Module | 1048 | 1/10/100 |
| AC23106MB | 10A - Push Button - 1 Way - 1 Module | 566 | 1/20/200 |
| AC23107MB | 10A - Push Button - 1 Way - with Locator - 1 Module | 754 | 1/20/200 |
| AC23108MB | 10A - Push Button - 2 Way - 1 Module | 830 | 1/5/50 |

Electric Roller Blinds

| | | | |
|------------------|---|------|----------|
| AC26104MB | Double Switch for Electric Shutter - 2 Module | 1376 | 1/10/100 |
|------------------|---|------|----------|

Dimmers and Fan Regulators

| | | | |
|------------------|---|-------|----------|
| AC24103MB | Light Dimmer - 60 to 400 Watts - 2 Module | 2304 | 1/10/100 |
| AC24105MB | Push Dimmer 0-10V - 2 Module | 13324 | 1/20 |
| AC24101MB | Push Dimmer 150W With Neutral - 1 Module | 19032 | 1/5/20 |
| AC24104MB | Push Dimmer 125W Without Neutral - 2 Module | 12372 | 1/20 |
| AC24106MB | Touch Dimmer 5-300W/75W - 2 Module | 11882 | 1/20 |
| AC24107MB | Rotary Dimmer 200W LED - 2 Module | 21782 | 1/10 |
| AC661MB | Fan Step Regulator - 100 Watts - ISI - 1 Module | 1848 | 1/5/50 |
| AC662MB | Fan Step Regulator - 100 Watts - ISI - 2 Module | 2280 | 1/10/100 |
| AC665MB | Fan Step Regulator - 70 Watts - ISI - 2 Module | 2420 | 1/10/100 |
| AC663MB | Fan Step Regulator - 120 Watts - ISI - 2 Module | 2440 | 1/10/100 |
| AC664MB | Fan Regulator - 8 Step - 100 Watts - ISI - 2 Module | 2164 | 1/10/100 |

* MRP - Maximum Retail Price Inclusive of all taxes including GST.
Red Cat. Nos - New Products

Bold Cat.Nos are products normally available with Legrand (India) Stockists. Cat.Nos that are not bold - delivery within 4 - 8 weeks from the date of order. Bold packing quantity is our mandatory packing. Orders to be placed by Legrand (India) Stockist in multiples of the same.

Arteor Advance™

NEW! Classic - Matt Black Mechanisms

| Cat.Nos | Description | MRP* ₹ / Unit | Pack |
|--------------------------------|---|------------------|----------|
| Indian Standard Sockets | | | |
| AC3163MB | 6A - Socket - with Shutter - 3 Pin - ISI - 2 Module | 472 | 1/20/200 |
| AC3166MB | 6/16A - Socket - with Shutter - 3 Pin - Indian - ISI - 2 Module | 922 | 1/10/100 |
| AC3167MB | 6/16A - Socket - with Shutter - 3 Pin - Indian - ISI - 3 Module | 1122 | 1/5/50 |

USB Chargers

| | | | |
|-----------------|---|-------|----------|
| AC3408MB | USB Charger - 3000mA/15 Watts - Type A - 1 Module | 4042 | 1/10/150 |
| AC3410MB | USB Charger - 3000mA/15 Watts - Type A + A - 1 Module | 4610 | 1/10/150 |
| AC3411MB | USB Charger - 3000mA/15 Watts - Type A + C - 1 Module | 5288 | 1/10/150 |
| AC3412MB | USB Charger - 3000mA/15 Watts - Type C + C - 1 Module | 5778 | 1/10/150 |
| AC3409MB | USB Charger - Power Delivery - 20 Watts - Type C - 1 Module | 7596 | 1/10/150 |
| AC3406MB | USB Charger - Power Delivery - 30 Watts - Type C + C - 2 Module | 11096 | 1/20 |
| AC3401MB | USB Charger - Power Delivery - 45 Watts - Type C - 2 Module | 14322 | 1/20 |
| AC3415MB | USB Charger - Power Delivery - 65 Watts - Type C + C - 3 Module | 17542 | 1/20 |

Data and Voice

| | | | |
|-----------------|--|------|----------|
| AC423MB | Telephone Socket - Double RJ11 - 1 Module | 860 | 1/20/200 |
| AC424MB | Telephone Socket - RJ11 - with Shutter - 1 Module | 520 | 1/20/200 |
| AC4306MB | Information Socket - RJ45 - Cat 6A - UTP - 1 Module | 2346 | 10/100 |
| AC4315MB | Information Socket - RJ45 Rear Pluggable - CAT6 - UTP - 2 Module | 5824 | 1/10/100 |

TV Sockets

| | | | |
|-----------------|---------------------------------|-----|----------|
| AC4110MB | TV Co - axial Socket - 1 Module | 524 | 1/20/200 |
|-----------------|---------------------------------|-----|----------|

Arteor Advance™

NEW! Classic - Matt Black Mechanisms

| Cat.Nos | Description | MRP* ₹ / Unit | Pack |
|---------|-------------|------------------|------|
|---------|-------------|------------------|------|

Electronic Chime

| | | | |
|----------------|----------------------------------|-----|----------|
| AC618MB | Bell Ding Dong - 230V - 2 Module | 856 | 1/10/100 |
|----------------|----------------------------------|-----|----------|

Buzzer

| | | | |
|----------------|--------------------------|------|-------|
| AC615MB | Buzzer - 230V - 1 Module | 2318 | 10/60 |
|----------------|--------------------------|------|-------|

Bell Call Indicator

| | | | |
|------------------|--------------------------------|------|----------|
| AC23105MB | Bell Call Indicator - 1 Module | 3534 | 1/20/200 |
|------------------|--------------------------------|------|----------|

Infrared Sensors

| | | | |
|------------------|--|-------|------|
| AC25102MB | IR Motion Sensor with Neutral - 2 Module | 14862 | 1/20 |
|------------------|--|-------|------|

Innovative Switch

| | | | |
|------------------|---|------|------|
| AC28102MB | Contactless Door Switch - 12-24-48 V - 2 Module | 8586 | 1/20 |
| AC28101MB | Contactless Light Switch - 230V AC - 2 Module | 7728 | 1/20 |

Skirting Light

| | | | |
|----------------|---|------|--------|
| AC653MB | Skirting Light - with LED - 230V - 3 Module | 1900 | 10/100 |
|----------------|---|------|--------|

Protectors & Accessories

| Cat.Nos | Description | MRP* ₹ / Unit | Pack |
|---------|-------------|------------------|------|
|---------|-------------|------------------|------|

Hotel "DND and MMR" functions

| | | | |
|------------------|---|------|----------|
| AC27107MB | Interlocked Internal DND & MMR Control Unit - 2 Module | 2734 | 1/10/100 |
| AC27108MB | External DND & MMR Control Unit - with Bell Push - 2 Module | 3778 | 1/5/50 |

Hotel Keycard Switch

| | | | |
|------------------|---|-------|------|
| AC27110MB | 16A - Key Card Switch - 230V - 2 Module | 9908 | 1/20 |
| AC27111MB | 16A - Key Card Switch with RFID - 230V - 2 Module | 10336 | 1/20 |

Shaver Socket

| | | | |
|----------------|--|-------|------|
| AC361MB | Shaver Socket - 230V/120 - 230V - with Earth Connector | 10302 | 1/10 |
|----------------|--|-------|------|

Time Switch

| | | | |
|------------------|------------------------------|-------|------|
| AC20110MB | Time Delay Switch - 2 Module | 12220 | 1/20 |
|------------------|------------------------------|-------|------|

* MRP - Maximum Retail Price Inclusive of all taxes including GST.
Red Cat. Nos - New Products

Bold Cat.Nos are products normally available with Legrand (India) Stockists. Cat.Nos that are not bold - delivery within 4 - 8 weeks from the date of order. Bold packing quantity is our mandatory packing. Orders to be placed by Legrand (India) Stockist in multiples of the same.

Arteor Advance™

NEW! Hospitality Function

| Cat.Nos | Description | MRP* ₹ / Unit | Pack |
|---------|-------------|------------------|------|
|---------|-------------|------------------|------|

Master Switch

| | | | |
|------------------|--|-----|----------|
| AC22114MB | 20A - Master Switch - DP - 2 Way - ON/OFF - 2 Module | 948 | 1/10/100 |
| AC23115MB | Master Push ON/OFF - 2 Way - 2 Module | 908 | 1/10/100 |



AC22114MB

Bedlight Switch

| | | | |
|------------------|--|-----|--------|
| AC21117MB | 10A - Bedlight Switch - 2 Way - 2X1 - 2 Module | 908 | 1/5/50 |
| AC23119MB | 10A - Push for Bedlight - 2 Way - 2X1 - 2 Module | 908 | 1/5/50 |



AC657MB

Reading Light

| | | | |
|----------------|------------------------------|------|------|
| AC657MB | Reading Light LED - 2 Module | 4348 | 1/12 |
|----------------|------------------------------|------|------|

Protectors & Accessories

Surge Protector

| | | | |
|----------------|----------------------------|------|--------|
| AC627MB | Surge Protector - 1 Module | 7364 | 20/200 |
|----------------|----------------------------|------|--------|



AC627MB

Motor Starter

| | | | |
|------------------|--------------------------------|------|----------|
| AC20111MB | 16A - Motor Starter - 2 Module | 1566 | 1/10/100 |
| AC20112MB | 25A - Motor Starter - 2 Module | 1604 | 1/10/100 |



AC20112MB

Modular MCB

| | | | |
|----------------|---|-----|--------|
| AC628MB | 16A - SP - Modular MCB - C Curve - 1 Module | 916 | 1/5/50 |
| AC625MB | 20A - SP - Modular MCB - C Curve - 1 Module | 916 | 1/5/50 |
| AC626MB | 32A - SP - Modular MCB - C Curve - 1 Module | 916 | 1/5/50 |



AC628MB



AC626MB

Audio-Video Sockets

| | | | |
|-----------------|--|-------|----------|
| AC4430MB | Female 3.5mm Jack - 1 Module | 7424 | 1/10 |
| AC4421MB | Preterminated Sockets Female Hd15 - 1 Module | 10240 | 1/10 |
| AC4411MB | Preterminated HDMI Socket - 1.4 - 1 Module | 11604 | 1/10 |
| AC4400MB | Loudspeaker Socket - 1 Module | 1300 | 1/10/100 |
| AC4452MB | Male XLR Jack - 2 Module | 10954 | 1/20 |
| AC4412MB | Preterminated HDMI Socket - 1.4 - 2 Module | 12188 | 1/10 |
| AC4106MB | TV-R-SAT Socket - 2 Module | 6582 | 1/0/10 |



AC4430MB



AC4411MB



AC4400MB



AC4412MB

Arteor Advance™

NEW! Protectors & Accessories

| Cat.Nos | Description | MRP* ₹ / Unit | Pack |
|---------|-------------|------------------|------|
|---------|-------------|------------------|------|

Audio-Video Sockets

| | | | |
|-----------------|--|-------|--------|
| AC4442MB | Triple RCA Socket (Audio & Video) - 1 Module | 6526 | 1/20 |
| AC4362MB | Preterminated USB Data Socket - 1 Module | 8754 | 1/10 |
| AC4360MB | USB Socket - 1 Module | 5882 | 2/0/20 |
| AC4470MB | Line Dying Down - 100V (25 - 30W) - 2 Module | 20912 | 1/20 |
| AC4450MB | Female XLR Jack - 2 Module | 13178 | 1/20 |
| AC4440MB | 2 Female RCA Socket - 1 Module | 5318 | 1/10 |



AC4362MB



AC4360MB



AC4470MB

Cable Outlet

| | | | |
|----------------|--|-----|--------|
| AC354MB | Cord Outlet - with 8mm Diameter - 1 Module | 638 | 20/200 |
|----------------|--|-----|--------|



AC354MB

Blanking Plate

| | | | |
|----------------|---------------------------|-----|----------|
| AC150MB | Blanking Plate - 1 Module | 80 | 1/40/400 |
| AC153MB | Blanking Plate - 2 Module | 138 | 1/10/100 |



AC153MB

Classic - Matt Titanium Mechanisms

Switches - 10A - 230V AC

| | | | |
|------------------|--|-----|----------|
| AC21104MT | 10A - Switch - 1 Way - 1 Module | 306 | 1/20/200 |
| AC21106MT | 10A - Switch - 1 Way - with Indicator - 1 Module | 558 | 1/20/200 |
| AC21105MT | 10A - Switch - 1 Way - with Locator - 1 Module | 558 | 1/20/200 |
| AC22105MT | 10A - Switch - 2 Way - 1 Module | 500 | 1/20/200 |
| AC22107MT | 10A - Switch - 2 Way - with Indicator - 1 Module | 714 | 1/20/200 |
| AC21119MT | 10A - Switch - 1 Way - with Indicator - 2 Module | 632 | 1/10/100 |



AC21104MT



AC22105MT



AC21119MT

* MRP - Maximum Retail Price Inclusive of all taxes including GST.
Red Cat. Nos - New Products

Bold Cat.Nos are products normally available with Legrand (India) Stockists. Cat.Nos that are not bold - delivery within 4 - 8 weeks from the date of order. Bold packing quantity is our mandatory packing. Orders to be placed by Legrand (India) Stockist in multiples of the same.

Arteor Advance™

NEW!

Classic - Matt Titanium Mechanisms

| Cat.Nos | Description | MRP* ₹ / Unit | Pack |
|---------------------------------|--|------------------|----------|
| Switches – 16A - 230V AC | | | |
| AC21101MT | 16A - Switch - 1 Way - 1 Module | 512 | 20/200 |
| AC21118MT | 16A - Switch - 1 Way - with Indicator - 1 Module | 640 | 1/20/200 |
| AC222101MT | 16A - Switch - 2 Way - 1 Module | 800 | 1/20/200 |
| AC222102MT | 16A - Switch - 2 Way - with Indicator - 1 Module | 818 | 1/20/200 |
| AC21103MT | 16A - Switch - 1 Way - 2 Module | 632 | 1/10/100 |
| AC20109MT | 16A - Intermediate Switch - 230V AC - 2 Module | 3970 | 1/10/100 |
| AC222109MT | 16A - Switch - 2 Way - 2 Module | 1036 | 1/10/100 |

Switches – 20A - 230V AC

| | | | |
|-------------------|--|------|----------|
| AC21107MT | 20A - Switch - 1 Way - 1 Module | 664 | 1/20/200 |
| AC21108MT | 20A - Switch - 1 Way - with Indicator - 1 Module | 768 | 1/20/200 |
| AC222106MT | 20A - Switch - 2 Way - 1 Module | 862 | 1/20/200 |
| AC222108MT | 20A - Switch - 2 Way - with Indicator - 1 Module | 958 | 1/20/200 |
| AC21112MT | 20A - Switch - 1 Way - 2 Module | 784 | 1/10/100 |
| AC222119MT | 20A - Switch - 2 Way - 2 Module | 924 | 1/10/100 |
| AC222113MT | 20A - Switch - 2 Way - with Indicator - 2 Module | 1030 | 1/10/100 |
| AC21312MT | 20A - Switch - 3 Gang - 1 Way - 2 Module | 1894 | 1/10/100 |
| AC29101MT | 20A - Switch - 3 Gang - 2X2 Way + 1X1 Way - 2 Module | 1984 | 1/10/100 |
| AC21113MT | 20A - Switch - DP - 1 Way - with Indicator - 2 Module | 1534 | 1/10/100 |
| AC20105MT | 20A - Switch - DP - 1 Way - with Indicator & Water Heater Marking - 2 Module | 1640 | 1/10/100 |

* MRP - Maximum Retail Price Inclusive of all taxes including GST.
Red Cat. Nos - New Products

Arteor Advance™

NEW!

Classic - Matt Titanium Mechanisms

| Cat.Nos | Description | MRP* ₹ / Unit | Pack |
|------------------------------------|---|------------------|----------|
| Switches – 25A - 230V AC | | | |
| AC21115MT | 25A - Switch - 1 Way - with Indicator - 1 Module | 880 | 1/20/200 |
| Switches – 32A - 230V AC | | | |
| AC20101MT | 32A - Switch - DP - 1 Way - with Indicator - 2 Module | 2140 | 1/10/100 |
| Push Button – 10A - 230V AC | | | |
| AC23102MT | 10A - Bell Push - 1 Way - 1 Module | 544 | 1/20/200 |
| AC23103MT | 10A - Bell Push - 1 Way - with Locator - 1 Module | 752 | 1/20/200 |
| AC23111MT | 10A - Bell Push - 1 Way - 2 Module | 778 | 1/10/100 |
| AC23112MT | 10A - Bell Push - 1 Way - with Locator - 2 Module | 1048 | 1/10/100 |
| AC23106MT | 10A - Push Button - 1 Way - 1 Module | 566 | 1/20/200 |
| AC23107MT | 10A - Push Button - 1 Way - with Locator - 1 Module | 754 | 1/20/200 |
| AC23108MT | 10A - Push Button - 2 Way - 1 Module | 830 | 1/5/50 |

Electric Roller Blinds

| | | | |
|------------------|---|------|----------|
| AC26104MT | Double Switch for Electric Shutter - 2 Module | 1432 | 1/10/100 |
|------------------|---|------|----------|

Dimmers and Fan Regulators

| | | | |
|------------------|---|-------|----------|
| AC24103MT | Light Dimmer - 60 to 400 Watts - 2 Module | 2304 | 1/10/100 |
| AC24105MT | Push Dimmer 0-10V - 2 Module | 13862 | 1/20 |
| AC24101MT | Push Dimmer 150W With Neutral - 1 Module | 19802 | 1/5/20 |
| AC24104MT | Push Dimmer 125W Without Neutral - 2 Module | 12872 | 1/20 |
| AC24106MT | Touch Dimmer 5-300W/75W - 2 Module | 11882 | 1/20 |
| AC24107MT | Rotary Dimmer 200W LED - 2 Module | 21782 | 1/10 |
| AC661MT | Fan Step Regulator - 100 Watts - ISI - 1 Module | 1848 | 1/5/50 |
| AC662MT | Fan Step Regulator - 100 Watts - ISI - 2 Module | 2280 | 1/10/100 |
| AC665MT | Fan Step Regulator - 70 Watts - ISI - 2 Module | 2420 | 1/10/100 |
| AC663MT | Fan Step Regulator - 120 Watts - ISI - 2 Module | 2440 | 1/10/100 |
| AC664MT | Fan Regulator - 8 Step - 100 Watts - ISI - 2 Module | 2164 | 1/10/100 |

Bold Cat.Nos are products normally available with Legrand (India) Stockists. Cat.Nos that are not bold - delivery within 4 - 8 weeks from the date of order. Bold packing quantity is our mandatory packing. Orders to be placed by Legrand (India) Stockist in multiples of the same.

Arteor Advance™

NEW! Classic - Matt Titanium Mechanisms

| Cat.Nos | Description | MRP* ₹ / Unit | Pack |
|--------------------------------|---|------------------|----------|
| Indian Standard Sockets | | | |
| AC3163MT | 6A - Socket - with Shutter - 3 Pin - ISI - 2 Module | 472 | 1/20/200 |
| AC3166MT | 6/16A - Socket - with Shutter - 3 Pin - Indian - ISI - 2 Module | 922 | 1/10/100 |
| AC3167MT | 6/16A - Socket - with Shutter - 3 Pin - Indian - ISI - 3 Module | 1122 | 1/5/50 |

USB Chargers

| | | | |
|-----------------|---|-------|----------|
| AC3408MT | USB Charger - 3000mA/15 Watts - Type A - 1 Module | 4042 | 1/10/150 |
| AC3410MT | USB Charger - 3000mA/15 Watts - Type A + A - 1 Module | 4610 | 1/10/150 |
| AC3411MT | USB Charger - 3000mA/15 Watts - Type A + C - 1 Module | 5288 | 1/10/150 |
| AC3412MT | USB Charger - 3000mA/15 Watts - Type C + C - 1 Module | 5778 | 1/10/150 |
| AC3409MT | USB Charger - Power Delivery - 20 Watts - Type C - 1 Module | 7596 | 1/10/150 |
| AC3406MT | USB Charger - Power Delivery - 30 Watts - Type C + C - 2 Module | 11096 | 1/20 |
| AC3401MT | USB Charger - Power Delivery - 45 Watts - Type C - 2 Module | 14322 | 1/20 |
| AC3415MT | USB Charger - Power Delivery - 65 Watts - Type C + C - 3 Module | 17542 | 1/20 |

Data and Voice

| | | | |
|-----------------|--|------|----------|
| AC423MT | Telephone Socket - Double RJ11 - 1 Module | 860 | 1/20/200 |
| AC424MT | Telephone Socket - RJ11 - with Shutter - 1 Module | 520 | 1/20/200 |
| AC4306MT | Information Socket - RJ45 - Cat 6A - UTP - 1 Module | 2346 | 10/100 |
| AC4315MT | Information Socket - RJ45 Rear Pluggable - CAT6 - UTP - 2 Module | 5824 | 1/10/100 |

TV Sockets

| | | | |
|-----------------|---------------------------------|-----|----------|
| AC4110MT | TV Co - axial Socket - 1 Module | 524 | 1/20/200 |
|-----------------|---------------------------------|-----|----------|

Arteor Advance™

NEW! Classic - Matt Titanium Mechanisms

| Cat.Nos | Description | MRP* ₹ / Unit | Pack |
|---------|-------------|------------------|------|
|---------|-------------|------------------|------|

Electronic Chime

| | | | |
|----------------|----------------------------------|-----|----------|
| AC618MT | Bell Ding Dong - 230V - 2 Module | 856 | 1/10/100 |
|----------------|----------------------------------|-----|----------|

Buzzer

| | | | |
|----------------|--------------------------|------|-------|
| AC615MT | Buzzer - 230V - 1 Module | 2318 | 10/60 |
|----------------|--------------------------|------|-------|

Bell Call Indicator

| | | | |
|------------------|--------------------------------|------|----------|
| AC23105MT | Bell Call Indicator - 1 Module | 3534 | 1/20/200 |
|------------------|--------------------------------|------|----------|

Infrared Sensors

| | | | |
|------------------|--|-------|------|
| AC25102MT | IR Motion Sensor with Neutral - 2 Module | 14862 | 1/20 |
|------------------|--|-------|------|

Innovative Switch

| | | | |
|------------------|---|------|------|
| AC28102MT | Contactless Door Switch - 12-24-48 V - 2 Module | 8586 | 1/20 |
| AC28101MT | Contactless Light Switch - 230V AC - 2 Module | 7728 | 1/20 |

Skirting Light

| | | | |
|----------------|---|------|--------|
| AC653MT | Skirting Light - with LED - 230V - 3 Module | 1900 | 10/100 |
|----------------|---|------|--------|

Hospitality Function

Hotel "DND and MMR" functions

| | | | |
|------------------|---|------|----------|
| AC27107MT | Interlocked Internal DND & MMR Control Unit - 2 Module | 2734 | 1/10/100 |
| AC27108MT | External DND & MMR Control Unit - with Bell Push - 2 Module | 3778 | 1/5/50 |

Hotel Keycard Switch

| | | | |
|------------------|---|-------|------|
| AC27110MT | 16A - Key Card Switch - 230V - 2 Module | 9908 | 1/20 |
| AC27111MT | 16A - Key Card Switch with RFID - 230V - 2 Module | 10336 | 1/20 |

Shaver Socket

| | | | |
|----------------|--|-------|------|
| AC361MT | Shaver Socket - 230V/120 - 230V - with Earth Connector | 10302 | 1/10 |
|----------------|--|-------|------|

Time Switch

| | | | |
|------------------|------------------------------|-------|------|
| AC20110MT | Time Delay Switch - 2 Module | 12220 | 1/20 |
|------------------|------------------------------|-------|------|

* MRP - Maximum Retail Price Inclusive of all taxes including GST.
Red Cat. Nos - New Products

Bold Cat.Nos are products normally available with Legrand (India) Stockists. Cat.Nos that are not bold - delivery within 4 - 8 weeks from the date of order. Bold packing quantity is our mandatory packing. Orders to be placed by Legrand (India) Stockist in multiples of the same.

Arteor Advance™

NEW!

Hospitality Function

| Cat.Nos | Description | MRP* ₹ / Unit | Pack |
|---------|-------------|------------------|------|
|---------|-------------|------------------|------|

Master Switch

| | | | |
|------------------|--|-----|----------|
| AC22114MT | 20A - Master Switch - DP - 2 Way - ON/OFF - 2 Module | 948 | 1/10/100 |
| AC23115MT | Master Push ON/OFF - 2 Way - 2 Module | 908 | 1/10/100 |

Bedlight Switch

| | | | |
|------------------|--|-----|--------|
| AC21117MT | 10A - Bedlight Switch - 2 Way - 2X1 2 Module | 908 | 1/5/50 |
| AC23119MT | 10A - Push for Bedlight - 2 Way - 2X1 2 Module | 908 | 1/5/50 |

Arteor Advance™

Protectors & Accessories

Surge Protector

| | | | |
|----------------|----------------------------|------|--------|
| AC627MT | Surge Protector - 1 Module | 7364 | 20/200 |
|----------------|----------------------------|------|--------|

Motor Starter

| | | | |
|------------------|--------------------------------|------|----------|
| AC20111MT | 16A - Motor Starter - 2 Module | 1566 | 1/10/100 |
| AC20112MT | 25A - Motor Starter - 2 Module | 1604 | 1/10/100 |

Modular MCB

| | | | |
|----------------|---|-----|--------|
| AC628MT | 16A - SP - Modular MCB - C Curve - 1 Module | 916 | 1/5/50 |
| AC625MT | 20A - SP - Modular MCB - C Curve - 1 Module | 916 | 1/5/50 |
| AC626MT | 32A - SP - Modular MCB - C Curve - 1 Module | 916 | 1/5/50 |

Audio-Video Sockets

| | | | |
|-----------------|--|-------|----------|
| AC4430MT | Female 3.5mm Jack - 1 Module | 7424 | 1/10 |
| AC4421MT | Preterminated Sockets Female Hd15 - 1 Module | 10240 | 1/10 |
| AC4411MT | Preterminated HDMI Socket - 1.4 - 1 Module | 11604 | 1/10 |
| AC4400MT | Loudspeaker Socket - 1 Module | 1300 | 1/10/100 |
| AC4452MT | Male XLR Jack - 2 Module | 10954 | 1/20 |

Arteor Advance™

NEW!

Protectors & Accessories

| Cat.Nos | Description | MRP* ₹ / Unit | Pack |
|---------|-------------|------------------|------|
|---------|-------------|------------------|------|

Audio-Video Sockets

| | | | |
|-----------------|--|-------|--------|
| AC4412MT | Preterminated HDMI Socket - 1.4 - 2 Module | 12188 | 1/10 |
| AC4106MT | TV-R-SAT Socket - 2 Module | 6582 | 1/0/10 |
| AC4442MT | Triple RCA Socket (Audio & Video) - 1 Module | 6526 | 1/20 |
| AC4362MT | Preterminated USB Data Socket - 1 Module | 8754 | 1/10 |
| AC4360MT | USB Socket - 1 Module | 5882 | 2/0/20 |
| AC4470MT | Line Dying Down - 100V (25 - 30W) - 2 Module | 21094 | 1/20 |
| AC4450MT | Female XLR Jack - 2 Module | 13178 | 1/20 |
| AC4440MT | 2 Female RCA Socket - 1 Module | 5318 | 1/10 |

Cable Outlet

| | | | |
|----------------|--|-----|--------|
| AC354MT | Cord Outlet - with 8mm Diameter - 1 Module | 632 | 20/200 |
|----------------|--|-----|--------|

Blanking Plate

| | | | |
|----------------|---------------------------|-----|----------|
| AC150MT | Blanking Plate - 1 Module | 80 | 1/40/400 |
| AC153MT | Blanking Plate - 2 Module | 138 | 1/10/100 |

Elite Matt White Mechanisms

| Cat.Nos | Description | MRP* ₹ / Unit | Pack |
|---------|-------------|------------------|------|
|---------|-------------|------------------|------|

Switches - 10A - 230V AC

| | | | |
|------------------|---|-----|----------|
| AA21104MW | 10A - Switch - 1 Way - 1 Module | 316 | 1/10/100 |
| AA21106MW | 10A - Switch - 1 Way - with Indicator - 1 Module | 586 | 1/10/100 |
| AA21105MW | 10A - Switch - 1 Way - with Locator - 1 Module | 586 | 1/10/100 |
| AA21102MW | 10A - Switch - 1 Way - with Locator (Blue) - 1 Module | 586 | 1/10/100 |
| AA22105MW | 10A - Switch - 2 Way - 1 Module | 520 | 1/10/100 |
| AA22107MW | 10A - Switch - 2 Way - with Indicator - 1 Module | 732 | 1/10/100 |

* MRP - Maximum Retail Price Inclusive of all taxes including GST.
Red Cat. Nos - New Products

Bold Cat.Nos are products normally available with Legrand (India) Stockists. Cat.Nos that are not bold - delivery within 4 - 8 weeks from the date of order. Bold packing quantity is our mandatory packing. Orders to be placed by Legrand (India) Stockist in multiples of the same.

Arteor Advance™

NEW! Elite Matt White Mechanisms

| Cat.Nos | Description | MRP* ₹ / Unit | Pack |
|---------|-------------|------------------|------|
|---------|-------------|------------------|------|

Switches – 16A - 230V AC

| | | | |
|------------------|--|-----|----------|
| AA21101MW | 16A - Switch - 1 Way - 1 Module | 528 | 1/10/100 |
| AA21120MW | 16A - Switch - 1 Way - with Indicator - 1 Module | 676 | 1/10/100 |
| AA22101MW | 16A - Switch - 2 Way - 1 Module | 828 | 1/10/100 |
| AA22102MW | 16A - Switch - 2 Way - with Indicator - 1 Module | 842 | 1/10/100 |

Switches – 20A - 230V AC

| | | | |
|------------------|--|------|----------|
| AA21107MW | 20A - Switch - 1 Way - 1 Module | 702 | 1/10/100 |
| AA21108MW | 20A - Switch - 1 Way - with Indicator - 1 Module | 798 | 1/10/100 |
| AA22106MW | 20A - Switch - 2 Way - 1 Module | 914 | 1/10/100 |
| AA22108MW | 20A - Switch - 2 Way - with Indicator - 1 Module | 1016 | 1/10/100 |

Push Button – 10A - 230V AC

| | | | |
|------------------|--|-----|----------|
| AA23102MW | 10A - Bell Push - 1 Way - 1 Module | 582 | 1/10/100 |
| AA23103MW | 10A - Bell Push - 1 Way - with Locator - 1 Module | 772 | 1/10/100 |
| AA23104MW | 10A - Bell Push - 1 Way - with Locator (Blue) - 1 Module | 772 | 1/10/100 |
| AA23101MW | 10A - Push Button - 1 Way - 1 Module | 616 | 1/10/100 |
| AA23108MW | 10A - Push Button - 2 Way - 1 Module | 856 | 1/10/100 |

Electric Roller Blinds

| | | | |
|------------------|---|------|--------|
| AA26104MW | Double Switch for Electric Shutter - 2 Module | 1420 | 1/5/50 |
|------------------|---|------|--------|

Dimmers and Fan Regulators

| | | | |
|------------------|---|-------|--------|
| AA24107MW | Rotary Dimmer 200W LED - 2 Module | 24158 | 1/10 |
| AA667MW | Fan Step Regulator - 70 Watts - ISI - 2 Module | 2532 | 1/3/30 |
| AA664MW | Fan Regulator - 8 Step - 100 Watts - ISI - 2 Module | 2264 | 1/3/30 |
| AA669MW | Fan Step Regulator - 120 Watts - ISI - 2 Module | 2540 | 1/3/30 |

Temperature Room Control Unit

| | | | |
|----------------|-------------------------------|-------|------|
| AA674MW | Temperature Room Control Unit | 20502 | 1/20 |
|----------------|-------------------------------|-------|------|

USB Chargers

| | | | |
|-----------------|---|-------|------|
| AA3406MW | USB Charger - Power Delivery - 30 Watts - Type C + C - 2 Module | 12730 | 1/20 |
| AA3401MW | USB Charger - Power Delivery - 45 Watts - Type C - 2 Module | 16428 | 1/20 |

* MRP - Maximum Retail Price Inclusive of all taxes including GST.
Red Cat. Nos - New Products

Arteor Advance™

NEW! Hospitality Function

| Cat.Nos | Description | MRP* ₹ / Unit | Pack |
|---------|-------------|------------------|------|
|---------|-------------|------------------|------|

Hotel "DND and MMR" functions

| | | | |
|------------------|---|------|--------|
| AA27107MW | Interlocked Internal DND & MMR Control Unit - 2 Module | 2838 | 1/5/50 |
| AA27108MW | External DND & MMR Control Unit - with Bell Push - 2 Module | 3956 | 1/5/50 |

Master Push Button

| | | | |
|------------------|---------------------------------------|-----|----------|
| AA23115MW | Master Push ON/OFF - 2 Way - 1 Module | 954 | 1/10/100 |
|------------------|---------------------------------------|-----|----------|

Bedlight Switch

| | | | |
|------------------|--|-----|--------|
| AA21117MW | 10A - Bedlight Switch - 2 Way - 2X1 2 Module | 934 | 1/5/50 |
| AA23119MW | 10A - Push for Bedlight - 2 Way - 2X1 2 Module | 934 | 1/5/50 |

Blanking Plate

| | | | |
|----------------|---------------------------|-----|----------|
| AA150MW | Blanking Plate - 1 Module | 102 | 1/10/100 |
|----------------|---------------------------|-----|----------|

Arteor Advance™

Elite Matt Black Mechanisms

| Cat.Nos | Description | MRP* ₹ / Unit | Pack |
|---------|-------------|------------------|------|
|---------|-------------|------------------|------|

Switches – 10A - 230V AC

| | | | |
|------------------|--|-----|----------|
| AA21104MB | 10A - Switch - 1 Way - 1 Module | 368 | 1/10/100 |
| AA21106MB | 10A - Switch - 1 Way - with Indicator - 1 Module | 668 | 1/10/100 |
| AA21105MB | 10A - Switch - 1 Way - with Locator - 1 Module | 668 | 1/10/100 |
| AA22105MB | 10A - Switch - 2 Way - 1 Module | 600 | 1/10/100 |
| AA22107MB | 10A - Switch - 2 Way - with Indicator - 1 Module | 856 | 1/10/100 |

Switches – 16A - 230V AC

| | | | |
|------------------|--|-----|----------|
| AA21101MB | 16A - Switch - 1 Way - 1 Module | 616 | 1/10/100 |
| AA21120MB | 16A - Switch - 1 Way - with Indicator - 1 Module | 768 | 1/10/100 |
| AA22101MB | 16A - Switch - 2 Way - 1 Module | 958 | 1/10/100 |
| AA22102MB | 16A - Switch - 2 Way - with Indicator - 1 Module | 984 | 1/10/100 |

Switches – 20A - 230V AC

| | | | |
|------------------|--|------|----------|
| AA21107MB | 20A - Switch - 1 Way - 1 Module | 798 | 1/10/100 |
| AA21108MB | 20A - Switch - 1 Way - with Indicator - 1 Module | 920 | 1/10/100 |
| AA22106MB | 20A - Switch - 2 Way - 1 Module | 1034 | 1/10/100 |
| AA22108MB | 20A - Switch - 2 Way - with Indicator - 1 Module | 1148 | 1/10/100 |

Bold Cat.Nos are products normally available with Legrand (India) Stockists. Cat.Nos that are not bold - delivery within 4 - 8 weeks from the date of order. Bold packing quantity is our mandatory packing. Orders to be placed by Legrand (India) Stockist in multiples of the same.

Arteor Advance™

NEW!

Elite Matt Black Mechanisms

| Cat.Nos | Description | MRP* ₹ / Unit | Pack |
|---------|-------------|------------------|------|
|---------|-------------|------------------|------|

Push Button – 10A - 230V AC

| | | | |
|------------------|---|-----|----------|
| AA23102MB | 10A - Bell Push - 1 Way - 1 Module | 654 | 1/10/100 |
| AA23103MB | 10A - Bell Push - 1 Way - with Locator - 1 Module | 902 | 1/10/100 |
| AA23101MB | 10A - Push Button - 1 Way - 1 Module | 680 | 1/10/100 |
| AA23108MB | 10A - Push Button - 2 Way - 1 Module | 996 | 1/5/50 |

Electric Roller Blinds and Curtain Control

| | | | |
|------------------|---|------|--------|
| AA26104MB | Double Switch for Electric Shutter - 2 Module | 1650 | 1/5/50 |
|------------------|---|------|--------|

Dimmers and Fan Regulators

| | | | |
|------------------|---|-------|--------|
| AA24107MB | Rotary Dimmer 200W LED - 2 Module | 26138 | 1/10 |
| AA667MB | Fan Step Regulator - 70 Watts - ISI - 2 Module | 2904 | 1/3/30 |
| AA664MB | Fan Regulator - 8 Step - 100 Watts - ISI - 2 Module | 2598 | 1/3/30 |
| AA669MB | Fan Step Regulator - 120 Watts - ISI - 2 Module | 2928 | 1/3/30 |

Temperature Room Control Unit

| | | | |
|----------------|-------------------------------|-------|------|
| AA674MB | Temperature Room Control Unit | 23578 | 1/20 |
|----------------|-------------------------------|-------|------|

USB Chargers

| | | | |
|-----------------|---|-------|------|
| AA3406MB | USB Charger - Power Delivery - 30 Watts - Type C + C - 2 Module | 13318 | 1/20 |
| AA3401MB | USB Charger - Power Delivery - 45 Watts - Type C - 2 Module | 17184 | 1/20 |

Arteor Advance™

Hospitality Function

Hotel "DND and MMR" functions

| | | | |
|------------------|---|------|--------|
| AA27107MB | Interlocked Internal DND & MMR Control Unit - 2 Module | 3278 | 1/5/50 |
| AA27108MB | External DND & MUR Control Unit - with Bell Push - 2 Module | 4532 | 1/5/50 |

Arteor Advance™

NEW!

Hospitality Function

| Cat.Nos | Description | MRP* ₹ / Unit | Pack |
|---------|-------------|------------------|------|
|---------|-------------|------------------|------|

Master Push Button

| | | | |
|------------------|---------------------------------------|------|----------|
| AA23115MB | Master Push ON/OFF - 2 Way - 1 Module | 1088 | 1/10/100 |
|------------------|---------------------------------------|------|----------|

Bedlight Switch

| | | | |
|------------------|--|------|--------|
| AA21117MB | 10A - Bedlight Switch - 2 Way - 2X1 2 Module | 1088 | 1/5/50 |
| AA23119MB | 10A - Push for Bedlight - 2 Way - 2X1 2 Module | 1088 | 1/5/50 |

Blanking Plate

| | | | |
|----------------|---------------------------|----|----------|
| AA150MB | Blanking Plate - 1 Module | 98 | 1/10/100 |
|----------------|---------------------------|----|----------|

Arteor Advance™

Elite - Matt Titanium Mechanisms

| Cat.Nos | Description | MRP* ₹ / Unit | Pack |
|---------|-------------|------------------|------|
|---------|-------------|------------------|------|

Switches – 10A - 230V AC

| | | | |
|------------------|--|-----|----------|
| AA21104MT | 10A - Switch - 1 Way - 1 Module | 368 | 1/10/100 |
| AA21106MT | 10A - Switch - 1 Way - with Indicator - 1 Module | 668 | 1/10/100 |
| AA21105MT | 10A - Switch - 1 Way - with Locator - 1 Module | 668 | 1/10/100 |
| AA22105MT | 10A - Switch - 2 Way - 1 Module | 600 | 1/10/100 |
| AA22107MT | 10A - Switch - 2 Way - with Indicator - 1 Module | 856 | 1/10/100 |

Switches – 16A - 230V AC

| | | | |
|------------------|--|-----|----------|
| AA21101MT | 16A - Switch - 1 Way - 1 Module | 616 | 1/10/100 |
| AA21120MT | 16A - Switch - 1 Way - with Indicator - 1 Module | 768 | 1/10/100 |
| AA22101MT | 16A - Switch - 2 Way - 1 Module | 958 | 1/10/100 |
| AA22102MT | 16A - Switch - 2 Way - with Indicator - 1 Module | 984 | 1/10/100 |

Switches – 20A - 230V AC

| | | | |
|------------------|--|------|----------|
| AA21107MT | 20A - Switch - 1 Way - 1 Module | 798 | 1/10/100 |
| AA21108MT | 20A - Switch - 1 Way - with Indicator - 1 Module | 920 | 1/10/100 |
| AA22106MT | 20A - Switch - 2 Way - 1 Module | 1034 | 1/10/100 |
| AA22108MT | 20A - Switch - 2 Way - with Indicator - 1 Module | 1148 | 1/10/100 |

* MRP - Maximum Retail Price Inclusive of all taxes including GST.
Red Cat. Nos - New Products

Bold Cat.Nos are products normally available with Legrand (India) Stockists. Cat.Nos that are not bold - delivery within 4 - 8 weeks from the date of order. Bold packing quantity is our mandatory packing. Orders to be placed by Legrand (India) Stockist in multiples of the same.

Arteor Advance™

NEW! Elite - Matt Titanium Mechanisms

| Cat.Nos | Description | MRP* ₹ / Unit | Pack |
|---------|-------------|------------------|------|
|---------|-------------|------------------|------|

Push Button – 10A - 230V AC

| | | | |
|------------------|---|-----|----------|
| AA23102MT | 10A - Bell Push - 1 Way - 1 Module | 654 | 1/10/100 |
| AA23103MT | 10A - Bell Push - 1 Way - with Locator - 1 Module | 902 | 1/10/100 |
| AA23101MT | 10A - Push Button - 1 Way - 1 Module | 680 | 1/10/100 |
| AA23108MT | 10A - Push Button - 2 Way - 1 Module | 996 | 1/5/50 |

Electric Roller Blinds and Curtain Control

| | | | |
|------------------|---|------|--------|
| AA26104MT | Double Switch for Electric Shutter - 2 Module | 1650 | 1/5/50 |
|------------------|---|------|--------|

Dimmers and Fan Regulators

| | | | |
|------------------|---|-------|--------|
| AA24107MT | Rotary Dimmer 200W LED - 2 Module | 26138 | 1/10 |
| AA667MT | Fan Step Regulator - 70 Watts - ISI - 2 Module | 2904 | 1/3/30 |
| AA664MT | Fan Regulator - 8 Step - 100 Watts - ISI - 2 Module | 2598 | 1/3/30 |
| AA669MT | Fan Step Regulator - 120 Watts - ISI - 2 Module | 2928 | 1/3/30 |

Temperature Room Control Unit

| | | | |
|----------------|-------------------------------|-------|------|
| AA674MT | Temperature Room Control Unit | 23578 | 1/20 |
|----------------|-------------------------------|-------|------|

USB Chargers

| | | | |
|-----------------|---|-------|------|
| AA3406MT | USB Charger - Power Delivery - 30 Watts - Type C + C - 2 Module | 13318 | 1/20 |
| AA3401MT | USB Charger - Power Delivery - 45 Watts - Type C - 2 Module | 17184 | 1/20 |

Hospitality Function

| Cat.Nos | Description | MRP* ₹ / Unit | Pack |
|---------|-------------|------------------|------|
|---------|-------------|------------------|------|

Hotel "DND and MMR" functions

| | | | |
|------------------|---|------|--------|
| AA27107MT | Interlocked Internal DND & MMR Control Unit - 2 Module | 3278 | 1/5/50 |
| AA27108MT | External DND & MMR Control Unit - with Bell Push - 2 Module | 4532 | 1/5/50 |

Arteor Advance™

NEW! Classic- Cover Plate with Support Frame

| Cat.Nos | Description | MRP* ₹ / Unit | Pack |
|---------|-------------|------------------|------|
|---------|-------------|------------------|------|

Master Push Button

| | | | |
|------------------|---------------------------------------|------|----------|
| AA23115MT | Master Push ON/OFF - 2 Way - 1 Module | 1088 | 1/10/100 |
|------------------|---------------------------------------|------|----------|

Bedlight Switch

| | | | |
|------------------|--|------|--------|
| AA21117MT | 10A - Bedlight Switch - 2 Way - 2X1 2 Module | 1088 | 1/5/50 |
| AA23119MT | 10A - Push for Bedlight - 2 Way - 2X1 2 Module | 1088 | 1/5/50 |

Blanking Plate

| | | | |
|----------------|---------------------------|----|----------|
| AA150MT | Blanking Plate - 1 Module | 98 | 1/10/100 |
|----------------|---------------------------|----|----------|

White Cover Plate with Support Frame

| | | | |
|-----------------|---|------|--------|
| AC1200MW | Cover Plate + Frame - 1 Module - Matt White | 510 | 10/100 |
| AC1201MW | Cover Plate + Frame - 2 Module - Matt White | 528 | 10/100 |
| AC1202MW | Cover Plate + Frame - 3 Module - Matt White | 612 | 10/100 |
| AC1203MW | Cover Plate + Frame - 4 Module - Matt White | 700 | 5/50 |
| AC1205MW | Cover Plate + Frame - 6 Module - Matt White | 964 | 5/30 |
| AC1207MW | Cover Plate + Frame - 8 Module - Matt White | 1140 | 5/30 |
| AC1208MW | Cover Plate + Frame - 2*4 Module - Matt White | 1666 | 2/20 |
| AC1212MW | Cover Plate + Frame - 9 Module - Matt White | 1768 | 5/30 |
| AC1210MW | Cover Plate + Frame - 2*6 Module - Matt White | 2216 | 2/16 |
| AC1213MW | Cover Plate + Frame - 2*8 Module - Matt White | 2436 | 2/16 |
| AC1211MW | Cover Plate + Frame - 3*6 Module - Matt White | 2872 | 2/12 |
| AC1136MW | Cover Plate - for Shaver Socket-3 Module - Matt White | 638 | 5/50 |

Matt Black Cover Plate with Support Frame

| | | | |
|-----------------|---|------|--------|
| AC1200MB | Cover Plate + Frame - 1 Module - Matt Black | 614 | 10/100 |
| AC1201MB | Cover Plate + Frame - 2 Module - Matt Black | 648 | 10/100 |
| AC1202MB | Cover Plate + Frame - 3 Module - Matt Black | 686 | 10/100 |
| AC1203MB | Cover Plate + Frame - 4 Module - Matt Black | 778 | 5/50 |
| AC1205MB | Cover Plate + Frame - 6 Module - Matt Black | 1330 | 5/30 |

* MRP - Maximum Retail Price Inclusive of all taxes including GST.
Red Cat. Nos - New Products

Bold Cat.Nos are products normally available with Legrand (India) Stockists. Cat.Nos that are not bold - delivery within 4 - 8 weeks from the date of order. Bold packing quantity is our mandatory packing. Orders to be placed by Legrand (India) Stockist in multiples of the same.

Arteor Advance™

NEW! Classic- Cover Plate with Support Frame

| Cat.Nos | Description | MRP* ₹ / Unit | Pack |
|---------|-------------|------------------|------|
|---------|-------------|------------------|------|

Matt Black Cover Plate with Support Frame

| | | | |
|-----------------|---|------|------|
| AC1207MB | Cover Plate + Frame - 8 Module - Matt Black | 1476 | 5/30 |
| AC1208MB | Cover Plate + Frame - 2*4 Module - Matt Black | 1872 | 2/20 |
| AC1212MB | Cover Plate + Frame - 9 Module - Matt Black | 1986 | 5/30 |
| AC1210MB | Cover Plate + Frame - 2*6 Module - Matt Black | 2430 | 2/16 |
| AC1213MB | Cover Plate + Frame - 2*8 Module - Matt Black | 2760 | 2/16 |
| AC1211MB | Cover Plate + Frame - 3*6 Module - Matt Black | 3226 | 2/12 |
| AC1136MB | Cover Plate - for Shaver Socket-3 Module - Matt Black | 1048 | 5/50 |

Matt Titanium Cover Plate with Support Frame

| | | | |
|-----------------|--|------|--------|
| AC1200MT | Cover Plate + Frame - 1 Module - Matt Titanium | 614 | 10/100 |
| AC1201MT | Cover Plate + Frame - 2 Module - Matt Titanium | 648 | 10/100 |
| AC1202MT | Cover Plate + Frame - 3 Module - Matt Titanium | 686 | 10/100 |
| AC1203MT | Cover Plate + Frame - 4 Module - Matt Titanium | 778 | 5/50 |
| AC1205MT | Cover Plate + Frame - 6 Module - Matt Titanium | 1330 | 5/30 |
| AC1207MT | Cover Plate + Frame - 8 Module - Matt Titanium | 1476 | 5/30 |
| AC1208MT | Cover Plate + Frame - 2*4 Module - Matt Titanium | 1872 | 2/20 |
| AC1212MT | Cover Plate + Frame - 9 Module - Matt Titanium | 1986 | 5/30 |
| AC1210MT | Cover Plate + Frame - 2*6 Module - Matt Titanium | 2430 | 2/16 |
| AC1213MT | Cover Plate + Frame - 2*8 Module - Matt Titanium | 2760 | 2/16 |
| AC1211MT | Cover Plate + Frame - 3*6 Module - Matt Titanium | 3226 | 2/12 |
| AC1136MT | Cover Plate - for Shaver Socket-3 Module - Matt Titanium | 1048 | 5/50 |

Frosted White Cover Plate with Support Frame

| | | | |
|-----------------|--|-----|--------|
| AC1200FW | Cover Plate + Frame - 1 Module - Frosted White | 788 | 1/5/30 |
| AC1201FW | Cover Plate + Frame - 2 Module - Frosted White | 842 | 1/5/30 |
| AC1202FW | Cover Plate + Frame - 3 Module - Frosted White | 902 | 1/20 |
| AC1203FW | Cover Plate + Frame - 4 Module - Frosted White | 960 | 1/20 |

Arteor Advance™

NEW! Classic- Cover Plate with Support Frame

| Cat.Nos | Description | MRP* ₹ / Unit | Pack |
|---------|-------------|------------------|------|
|---------|-------------|------------------|------|

Frosted White Cover Plate with Support Frame

| | | | |
|-----------------|--|------|--------|
| AC1205FW | Cover Plate + Frame - 6 Module - Frosted White | 1746 | 1/5/30 |
| AC1207FW | Cover Plate + Frame - 8 Module - Frosted White | 1922 | 1/5/30 |
| AC1208FW | Cover Plate + Frame - 2*4 Module - Frosted White | 2482 | 1/10 |
| AC1210FW | Cover Plate + Frame - 2*6 Module - Frosted White | 2998 | 1/16 |
| AC1136FW | Cover Plate - for Shaver Socket-3 Module - Frosted White | 1840 | 1/5/50 |

Frosted Black Cover Plate with Support Frame

| | | | |
|-----------------|--|------|--------|
| AC1200FB | Cover Plate + Frame - 1 Module - Frosted Black | 788 | 1/5/30 |
| AC1201FB | Cover Plate + Frame - 2 Module - Frosted Black | 842 | 1/5/30 |
| AC1202FB | Cover Plate + Frame - 3 Module - Frosted Black | 902 | 1/20 |
| AC1203FB | Cover Plate + Frame - 4 Module - Frosted Black | 960 | 1/20 |
| AC1205FB | Cover Plate + Frame - 6 Module - Frosted Black | 1746 | 1/5/30 |
| AC1207FB | Cover Plate + Frame - 8 Module - Frosted Black | 1922 | 1/5/30 |
| AC1208FB | Cover Plate + Frame - 2*4 Module - Frosted Black | 2482 | 1/10 |
| AC1210FB | Cover Plate + Frame - 2*6 Module - Frosted Black | 2998 | 1/16 |
| AC1136FB | Cover Plate - for Shaver Socket-3 Module - Frosted Black | 1840 | 1/5/50 |

Brushed Stainless Steel Cover Plate with Support Frame

| | | | |
|-----------------|--|------|--------|
| AC1200BS | Cover Plate + Frame - 1 Module - Brushed Stainless Steel | 3596 | 1/5/30 |
| AC1201BS | Cover Plate + Frame - 2 Module - Brushed Stainless Steel | 3844 | 1/5/30 |
| AC1202BS | Cover Plate + Frame - 3 Module - Brushed Stainless Steel | 4134 | 1/20 |
| AC1203BS | Cover Plate + Frame - 4 Module - Brushed Stainless Steel | 4388 | 1/20 |

* MRP - Maximum Retail Price Inclusive of all taxes including GST.
Red Cat. Nos - New Products

Bold Cat.Nos are products normally available with Legrand (India) Stockists. Cat.Nos that are not bold - delivery within 4 - 8 weeks from the date of order. Bold packing quantity is our mandatory packing. Orders to be placed by Legrand (India) Stockist in multiples of the same.

Arteor Advance™

NEW! Classic- Cover Plate with Support Frame

| Cat.Nos | Description | MRP* ₹ / Unit | Pack |
|-----------------|---|------------------|--------|
| AC1205BS | Cover Plate + Frame - 6 Module - Brushed Stainless Steel | 7986 | 1/5/30 |
| AC1207BS | Cover Plate + Frame - 8 Module - Brushed Stainless Steel | 8782 | 1/5/30 |
| AC1208BS | Cover Plate + Frame - 2*4 Module - Brushed Stainless Steel | 11100 | 1/10 |
| AC1210BS | Cover Plate + Frame - 2*6 Module - Brushed Stainless Steel | 13682 | 1/16 |
| AC1136BS | Cover Plate - for Shaver Socket-3 Module - Brushed Stainless Steel | 4098 | 1/5/50 |

Solid Aluminium Cover Plate with Support Frame

| | | | |
|-----------------|---|-------|--------|
| AC1200SA | Cover Plate + Frame - 1 Module - Solid Aluminium | 5134 | 1/5/30 |
| AC1201SA | Cover Plate + Frame - 2 Module - Solid Aluminium | 5494 | 1/5/30 |
| AC1202SA | Cover Plate + Frame - 3 Module - Solid Aluminium | 5908 | 1/20 |
| AC1203SA | Cover Plate + Frame - 4 Module - Solid Aluminium | 6270 | 1/20 |
| AC1205SA | Cover Plate + Frame - 6 Module - Solid Aluminium | 11408 | 1/5/30 |
| AC1207SA | Cover Plate + Frame - 8 Module - Solid Aluminium | 12544 | 1/5/30 |
| AC1208SA | Cover Plate + Frame - 2*4 Module - Solid Aluminium | 15856 | 1/10 |
| AC1210SA | Cover Plate + Frame - 2*6 Module - Solid Aluminium | 19546 | 1/16 |
| AC1136SA | Cover Plate - for Shaver Socket-3 Module - Solid Aluminium | 5854 | 1/5/50 |

Midnight Blue Cover Plate with Support Frame

| | | | |
|-----------------|--|------|--------|
| AC1200NB | Cover Plate + Frame - 1 Module - Midnight Blue | 5134 | 1/5/30 |
| AC1201NB | Cover Plate + Frame - 2 Module - Midnight Blue | 5494 | 1/5/30 |

Arteor Advance™

NEW! Elite- Cover Plate with Support Frame

| Cat.Nos | Description | MRP* ₹ / Unit | Pack |
|---|--|------------------|--------|
| Midnight Blue Cover Plate with Support Frame | | | |
| AC1202NB | Cover Plate + Frame - 3 Module - Midnight Blue | 5908 | 1/20 |
| AC1203NB | Cover Plate + Frame - 4 Module - Midnight Blue | 6270 | 1/20 |
| AC1205NB | Cover Plate + Frame - 6 Module - Midnight Blue | 11408 | 1/5/30 |
| AC1207NB | Cover Plate + Frame - 8 Module - Midnight Blue | 12544 | 1/5/30 |
| AC1208NB | Cover Plate + Frame - 2*4 Module - Midnight Blue | 15856 | 1/10 |
| AC1210NB | Cover Plate + Frame - 2*6 Module - Midnight Blue | 19546 | 1/16 |
| AC1136NB | Cover Plate - for Shaver Socket-3 Module - Midnight Blue | 5854 | 1/5/50 |

Round Plates with Support Frame

| | | | |
|-----------------|--|-----|--------|
| AA1202MW | Cover Plate + Frame - 2 Module - Round - Matt White | 658 | 10/100 |
| AA1202MB | Cover Plate + Frame - 2 Module - Round - Matt Black | 808 | 10/100 |
| AA1202MT | Cover Plate + Frame - 2 Module - Round - Matt Titanium | 808 | 10/100 |

Frosted White Cover Plate with Support Frame

| | | | |
|-------------------|--|------|--------|
| AA1200FW | Cover Plate + Frame - 1 Module - 1 x Elite - Frosted White | 984 | 1/5/30 |
| AA1201FW | Cover Plate + Frame - 2 Module - 2 x Elite - Frosted White | 1054 | 1/5/30 |
| AA1202FW | Cover Plate + Frame - 2 Module - Round - Frosted White | 1054 | 1/5/30 |
| AA1203FW | Cover Plate + Frame - 3 Module - 3 x Elite - Frosted White | 1130 | 1/20 |
| AA1204FW** | Cover Plate + Frame - 4 Module - 4 x Elite - Frosted White | 1248 | 1/5/30 |

* MRP - Maximum Retail Price Inclusive of all taxes including GST.
**Lead Time : 8 - 10 weeks after order booking
Red Cat. Nos - New Products

Bold Cat.Nos are products normally available with Legrand (India) Stockists.
Cat.Nos that are not bold - delivery within 4 - 8 weeks from the date of order.
Bold packing quantity is our mandatory packing. Orders to be placed by
Legrand (India) Stockist in multiples of the same.

Arteor Advance™

NEW! Elite- Cover Plate with Support Frame

| Cat.Nos | Description | MRP* ₹ / Unit | Pack |
|-------------------|--|------------------|--------|
| AA1200FB | Cover Plate + Frame - 1 Module - 1 x Elite - Frosted Black | 984 | 1/5/30 |
| AA1201FB | Cover Plate + Frame - 2 Module - 2 x Elite - Frosted Black | 1054 | 1/5/30 |
| AA1202FB | Cover Plate + Frame - 2 Module - Round - Frosted Black | 1054 | 1/5/30 |
| AA1203FB | Cover Plate + Frame - 3 Module - 3 x Elite - Frosted Black | 1130 | 1/20 |
| AA1204FB** | Cover Plate + Frame - 4 Module - 4 x Elite - Frosted Black | 1248 | 1/5/30 |

Brushed Stainless Steel Cover Plate with Support Frame

| | | | |
|-----------------|---|------|--------|
| AA1200BS | Cover Plate + Frame - 1 Module - 1 x Elite - Brushed Stainless Steel | 4492 | 1/5/30 |
| AA1201BS | Cover Plate + Frame - 2 Module - 2 x Elite - Brushed Stainless Steel | 4806 | 1/5/30 |
| AA1202BS | Cover Plate + Frame - 2 Module - Round - Brushed Stainless Steel | 4806 | 1/5/30 |
| AA1203BS | Cover Plate + Frame - 3 Module - 3 x Elite - Brushed Stainless Steel | 5170 | 1/20 |

Solid Aluminium Cover Plate with Support Frame

| | | | |
|-------------------|--|------|--------|
| AA1200SA | Cover Plate + Frame - 1 Module - 1 x Elite - Solid Aluminium | 6418 | 1/5/30 |
| AA1201SA | Cover Plate + Frame - 2 Module - 2 x Elite - Solid Aluminium | 6870 | 1/5/30 |
| AA1202SA | Cover Plate + Frame - 2 Module - Round - Solid Aluminium | 6870 | 1/5/30 |
| AA1203SA | Cover Plate + Frame - 3 Module - 3 x Elite - Solid Aluminium | 7386 | 1/20 |
| AA1204SA** | Cover Plate + Frame - 4 Module - 4 x Elite - Solid Aluminium | 8150 | 1/5/30 |

* MRP - Maximum Retail Price Inclusive of all taxes including GST.
**Lead Time : 8 - 10 weeks after order booking
Red Cat. Nos - New Products

Arteor Advance™



NEW! Hybrid(Classic+Elite)- Cover Plate with Support Frame

| Cat.Nos | Description | MRP* ₹ / Unit | Pack |
|-------------------|--|------------------|--------|
| AA1200NB | Cover Plate + Frame - 1 Module - 1 x Elite - Midnight Blue | 6418 | 1/5/30 |
| AA1201NB | Cover Plate + Frame - 2 Module - 2 x Elite - Midnight Blue | 6870 | 1/5/30 |
| AA1202NB | Cover Plate + Frame - 2 Module - Round - Midnight Blue | 6870 | 1/5/30 |
| AA1203NB | Cover Plate + Frame - 3 Module - 3 x Elite - Midnight Blue | 7386 | 1/20 |
| AA1204NB** | Cover Plate + Frame - 4 Module - 4 x Elite - Midnight Blue | 8150 | 1/5/30 |

Frosted White Cover Plate with Support Frame

| | | | |
|-----------------|---|------|--------|
| AB1208FW | Cover Plate + Frame - 4 Module - 2 x Classic + 2 x Elite - Frosted White | 1248 | 1/20 |
| AB1203FW | Cover Plate + Frame - 6 Module - 3 x Classic + 2 x Elite - Frosted White | 2270 | 1/5/30 |
| AB1205FW | Cover Plate + Frame - 6 Module - 4 x Classic + 1 x Elite - Frosted White | 2270 | 1/5/30 |
| AB1202FW | Cover Plate + Frame - 6 Module - 3 x Classic + Round - Frosted White | 2270 | 1/5/30 |
| AB1207FW | Cover Plate + Frame - 8 Module - 5 x Classic + Round - Frosted White | 2498 | 1/5/30 |

Frosted Black Cover Plate with Support Frame

| | | | |
|-----------------|---|------|--------|
| AB1208FB | Cover Plate + Frame - 4 Module - 2 x Classic + 2 x Elite - Frosted Black | 1248 | 1/20 |
| AB1203FB | Cover Plate + Frame - 6 Module - 3 x Classic + 2 x Elite - Frosted Black | 2270 | 1/5/30 |
| AB1205FB | Cover Plate + Frame - 6 Module - 4 x Classic + 1 x Elite - Frosted Black | 2270 | 1/5/30 |
| AB1202FB | Cover Plate + Frame - 6 Module - 3 x Classic + Round - Frosted Black | 2270 | 1/5/30 |
| AB1207FB | Cover Plate + Frame - 8 Module - 5 x Classic + Round - Frosted Black | 2498 | 1/5/30 |

Bold Cat.Nos are products normally available with Legrand (India) Stockists.
Cat.Nos that are not bold - delivery within 4 - 8 weeks from the date of order.
Bold packing quantity is our mandatory packing. Orders to be placed by
Legrand (India) Stockist in multiples of the same.

Hybrid(Classic+Elite)- Cover Plate with Support Frame

NEW!

| Cat.Nos | Description | MRP* ₹ / Unit | Pack |
|---|--|------------------|--------|
| Brushed Stainless Steel Cover Plate with Support Frame | | | |
| AB1208BS | Cover Plate + Frame - 4 Module - 2 x Classic + 2 x Elite - Brushed Stainless Steel | 5704 | 1/20 |
| AB1203BS | Cover Plate + Frame - 6 Module - 3 x Classic + 2 x Elite - Brushed Stainless Steel | 10382 | 1/5/30 |
| AB1205BS | Cover Plate + Frame - 6 Module - 4 x Classic + 1 x Elite - Brushed Stainless Steel | 10382 | 1/5/30 |
| AB1202BS | Cover Plate + Frame - 6 Module - 3 x Classic + Round - Brushed Stainless Steel | 10382 | 1/5/30 |
| AB1207BS | Cover Plate + Frame - 8 Module - 5 x Classic + Round - Brushed Stainless Steel | 11418 | 1/5/30 |



AB1205BS



AB1202BS



AB1207BS

Solid Aluminium Cover Plate with Support Frame

| | | | |
|-----------------|--|-------|--------|
| AB1208SA | Cover Plate + Frame - 4 Module - 2 x Classic + 2 x Elite - Solid Aluminium | 8150 | 1/20 |
| AB1203SA | Cover Plate + Frame - 6 Module - 3 x Classic + 2 x Elite - Solid Aluminium | 14832 | 1/5/30 |
| AB1205SA | Cover Plate + Frame - 6 Module - 4 x Classic + 1 x Elite - Solid Aluminium | 14832 | 1/5/30 |
| AB1202SA | Cover Plate + Frame - 6 Module - 3 x Classic + Round - Solid Aluminium | 14832 | 1/5/30 |
| AB1207SA | Cover Plate + Frame - 8 Module - 5 x Classic + Round - Solid Aluminium | 16306 | 1/5/30 |



AB1208SA



AB1203SA



AB1202SA

Midnight Blue Cover Plate with Support Frame

| | | | |
|-----------------|--|-------|--------|
| AB1208NB | Cover Plate + Frame - 4 Module - 2 x Classic + 2 x Elite - Midnight Blue | 8150 | 1/20 |
| AB1203NB | Cover Plate + Frame - 6 Module - 3 x Classic + 2 x Elite - Midnight Blue | 14832 | 1/5/30 |



AB1208NB



AB1205NB



AB1202NB



6890 07



6890 09



6890 10



6890 12

Hybrid(Classic+Elite)- Cover Plate with Support Frame

NEW!

| Cat.Nos | Description | MRP* ₹ / Unit | Pack |
|-----------------|--|------------------|--------|
| AB1205NB | Cover Plate + Frame - 6 Module - 4 x Classic + 1 x Elite - Midnight Blue | 14832 | 1/5/30 |
| AB1202NB | Cover Plate + Frame - 6 Module - 3 x Classic + Round - Midnight Blue | 14832 | 1/5/30 |
| AB1207NB | Cover Plate + Frame - 8 Module - 5 x Classic + Round - Midnight Blue | 16306 | 1/5/30 |

Arteor Advance™







Accessories- Metal Flush Boxes

| | | | |
|----------------|------------------------------|-----|----|
| 6890 07 | Metal Flush Box - 1/2 Module | 170 | 40 |
| 6890 08 | Metal Flush Box - 3 Module | 170 | 40 |
| 6890 09 | Metal Flush Box - 4 Module | 226 | 40 |
| 6890 10 | Metal Flush Box - 6 Module | 358 | 40 |
| 6890 42 | Metal Flush Box - 8 Module | 416 | 40 |
| 6890 31 | Metal Flush Box - 4*2 Module | 414 | 20 |
| 6890 29 | Metal Flush Box - 9 Module | 490 | 20 |
| 6890 11 | Metal Flush Box -12 Module | 624 | 10 |
| 6890 13 | Metal Flush Box -16 Module | 720 | 10 |
| 6890 12 | Metal Flush Box - 18 Module | 788 | 10 |

* MRP - Maximum Retail Price Inclusive of all taxes including GST.
Red Cat. Nos - New Products

Arteor Advance™

NEW! Accessories- Metal Flush Boxes

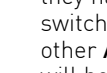
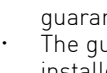
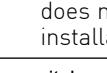
| Cat.Nos | Description | MRP* ₹ / Unit | Pack |
|--|----------------------------------|------------------|------|
| Surface Mounting Boxes | | | |
|  A1605WH | Plastic Surface Box - 1/2 Module | 166 | 55 |
|  A1606WH | Plastic Surface Box - 3 Module | 202 | 42 |
|  A1607WH | Plastic Surface Box - 4 Module | 238 | 27 |
|  A1608WH | Plastic Surface Box - 6 Module | 298 | 20 |
|  A1609WH | Plastic Surface Box - 8 Module | 336 | 20 |
|  A1611WH | Plastic Surface Box - 4*2 Module | 410 | 10 |
|  A1610WH | Plastic Surface Box - 9 Module | 422 | 18 |
|  A1612WH | Plastic Surface Box - 12 Module | 1046 | 11 |
|  A1614WH | Plastic Surface Box - 16 Module | 1078 | 11 |
|  A1613WH | Plastic Surface Box - 18 Module | 1106 | 8 |

Arteor Advance™

Guarantee

- The Company, at its discretion, will replace products if they have any manufacturing defect within 10 years for switches (without LED lamp) and power sockets. For all other **Arteor Advance™** wiring accessories the guarantee will be 2 years.
- The above guarantee is applicable when the devices are used in Legrand metal flush boxes. Otherwise the guarantee period will be reduced by 50%.
- The guarantee is only applicable when the products are installed as per the Company's instructions and not tampered in any manner.
- The guarantee states the Company's entire liability. It does not extend to cover consequential loss or damage or installation costs arising from defective products.

Our switches are compliant with revised BIS standard (IS 3854:2023) requirements. Also, our switches are covered additionally for use on Self-Ballasted Lamp (SBL) loads.

SBL power rating as per IS3854:2023

| Switch Rating | 6A, 230V~ | 10A, 230V~ | 16A, 230V~ | 20A, 230V~ |
|------------------|-----------|------------|------------|------------|
| SBL power (Watt) | 100 W | 100 W | 200 W | 250 W |

* MRP - Maximum Retail Price Inclusive of all taxes including GST.
Red Cat. Nos - New Products

Smart Home

One system - two technologies



Simply smart
Arteor™ Advance WITH IoT



Home + Control

Arteor Advance with IoT is the ideal solution for medium-sized projects and modernisation. The smart range is Zigbee 3.0 compatible and Wi-Fi enabled, using conventional cabling, making it easy to install, expand and modify. It is available for all common installation standards and used almost anywhere in the world. The Home + Control app is used for configuration, monitoring and control on a day-to-day basis, and installations can also be operated via the switch or using a voice assistant.



Smart Zigbee / Wi-Fi gateway

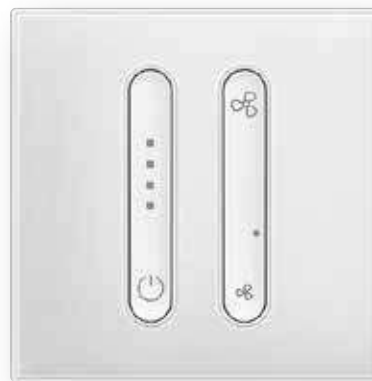

Smart fan controller 4 speeds

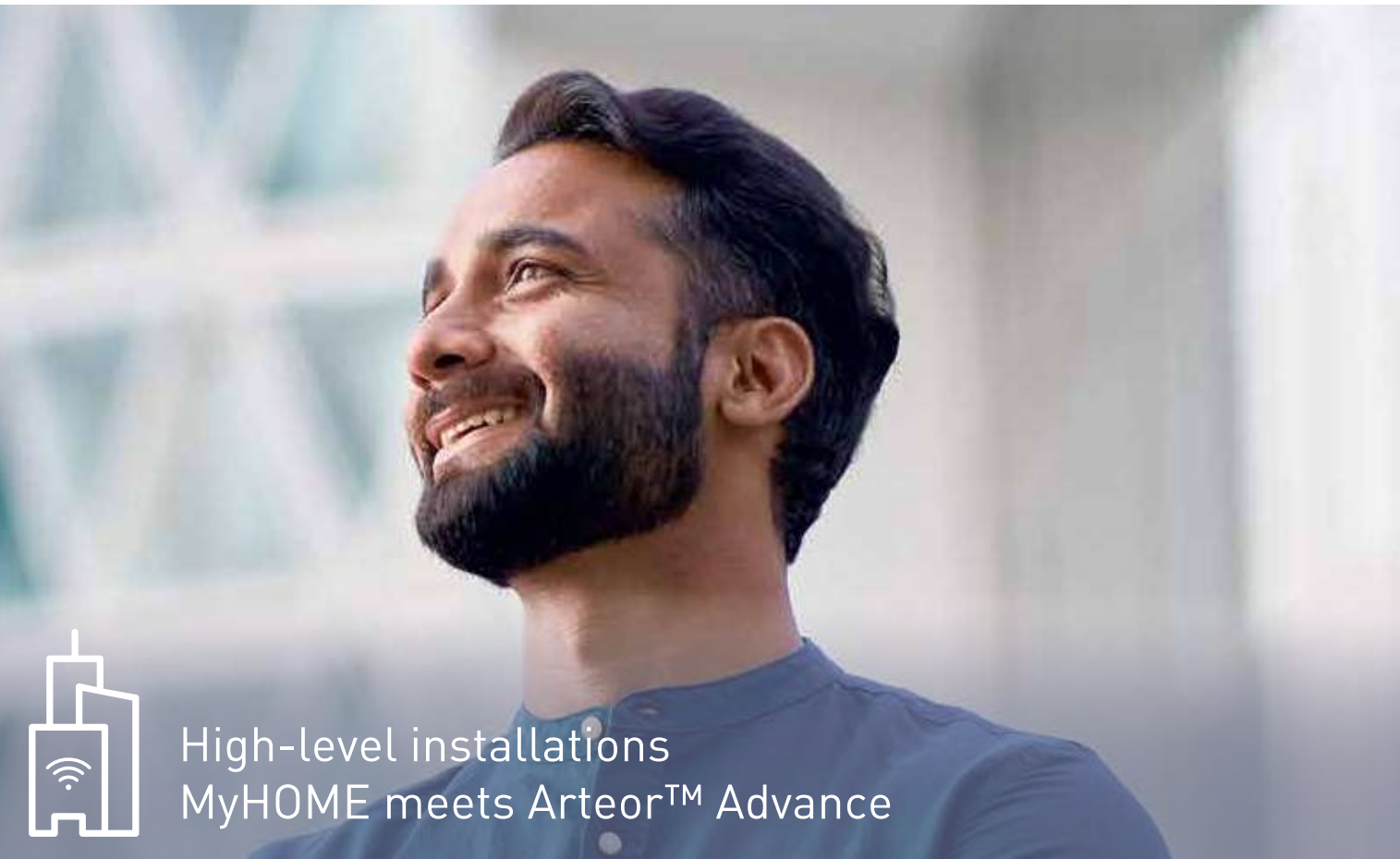

High-level installations MyHOME meets Arteor™ Advance

Arteor Advance also offers the Bus-based MyHOME solution for comprehensive new-build big installations such as villas or projects where all functions need to be fully automated. More powerful than before, MyHOME enables configuration of up to 525 addresses with the new address extension interface. The MyHOME installation can be configured with the Home + Project app and controlled via the Home + Control app, HOMETOUCH screen and voice assistants.



Home + Control



Home + Project



New MyHOME Server - available also in a version for third party integration



DALI-2 compatible dimming



Multifunction control

Smart Home



Smarter living

Whether radio solution or Bus-based system: Arteor Advance offers all the components needed to make a modern home smart, including switches, dimmers, controls for shading systems, fan controllers for smart ventilation control among others. Smart socket outlets for remote switching of standard lamps and other electrical devices, scene switches and Bus-based multifunction controls expand the number of possible options.



Lighting control: Wireless switches are available with battery and in a batteryless version: for less maintenance effort and lower environmental impact.



Individual, group or centralised control of shutters, shades and curtains



Fan controllers ensure a comfortable individual temperature.



Preprogrammed or customised scenes for greater comfort



Smart socket outlets – easy remote switching of standard lamps and other electrical devices



Bus dimming control



Bus control for shutters and shades



Bus 4 scenes control

Maximum functionality in a minimum of space.

The new Bus-based multifunction controls provide an improved control experience and optimise the management of groups and scenes in a minimum of space: Up to 4 functions in 2 modules or up to 6 functions in 3 modules can be combined to suit individual requirements and personalised with new dedicated Arteor Advance key covers. A perfect blend of design and functionality for a premium control experience.



Better design for KNX experts

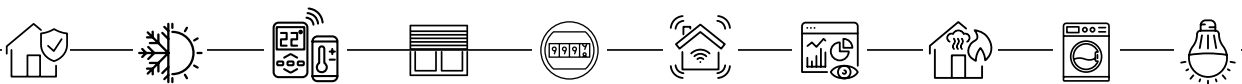

KNX is a widely used option whenever sophisticated automation is required for luxury villas and tertiary buildings. Blending technological performance with style, Arteor Advance KNX enables system integrators to realise complex automation projects with a spectacular design.

Arteor Advance KNX solutions offer full interoperability with all third-party applications and systems. It will thus be possible to create advanced solutions for the intelligent management of comfort and energy saving functions in hotels, hospitals, tertiary and luxury residential environments.

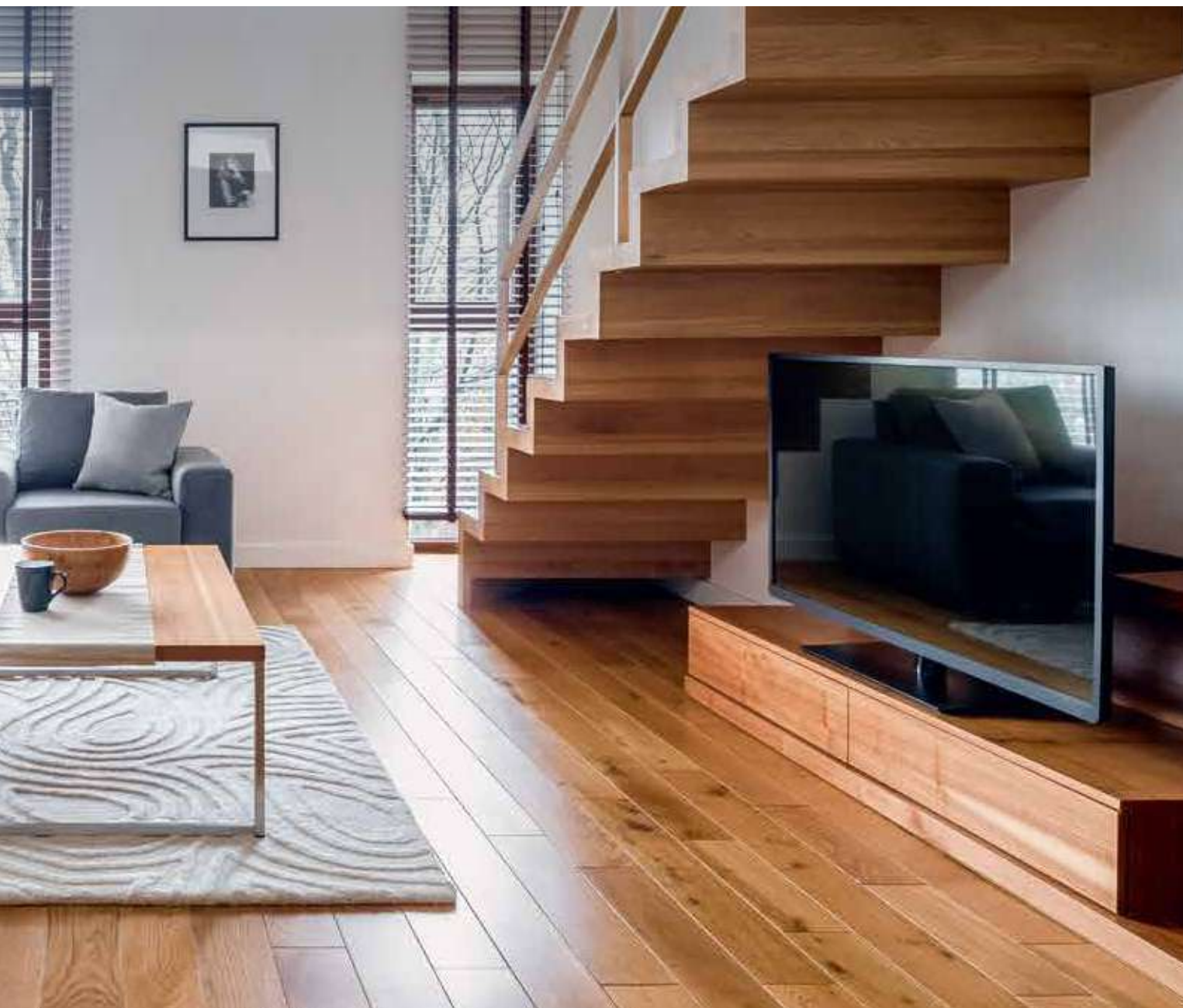

Multifunction control

KNX certified control device for perfect interoperability between Arteor Advance and third-party KNX products. Enabling management of up to 4 functions, it is configurable with ETS software and editable at any time. Arteor Advance key covers will add a touch of elegance to the control unit.

Arteor™ Advance KNX



Lighting control

For ON/OFF and dimming control of standard and multicolour lamps.



Shutter control

For control of shutters and awnings. Raise/lower/stop function and memorisation of favourite position.



Temperature control

Setting temperature, fan speed and control modes for any kind of HVAC: ON-OFF valves, ON-OFF and 0-10V floor control units or VRV/VRF systems



Scenes

Just one touch for setting lights, shutters and temperature to create comfort scenes and to save energy.



Open for everything: Arteor™ Advance and KNX

The KNX solutions from the Arteor Advance range can be integrated into an active general building management system. Not only for an optimum control of lighting, shutters, temperature and scenes. System integrators are also free to complete their projects with products from different manufacturers for security functions or heating and ventilation. It is also possible to display energy consumption or to be alerted when a fault occurs.



Touch Screen

Full KNX control on 15 pages including energy metering value display, timed functions, scene group function and logic functions.



Controller

Modular multifunction controller for On/Off control of lighting, shutters and HVAC with the same device. Designed for centralized installation with maximum flexibility.

















Presence Sensors

For advanced automation functions required in any “green” building. More energy efficiency through programmed lighting maintenance and scenario triggering dependent on presence / absence, natural light level or time.

Arteor Advance™ IoT













NEW! Connected Homes-Classic Matt White Mechanism

| Cat.Nos | Description | MRP* ₹ / Unit | Pack |
|---|---|------------------|--------|
| Connected Light Switches | | | |
|  AC52113MW | Classic - Connected Switch - with Neutral - Wired - 1 Module | 11860 | 1/5/20 |
|  AC52112MW | Classic - Connected Switch Dimmer - with Neutral - 150 Watts - 1 Module | 13622 | 1/5/50 |
| Connected Outlets | | | |
|  AC5412MW | Classic - 16A - Connected Socket Module - 1 Module | 13508 | 1/5/50 |
| Connected Curtain/Roller Blind Switches | | | |
|  AC5310MW | Classic - Connected Curtain/Roller Blind Switch - Wired - 1 Module | 14424 | 1/5/20 |
| Connected Step Fan controller | | | |
|  AC5510MW | Classic - Connected Step Fan Controller - with Neutral -100W - 2 Module | 9988 | 1/10 |
| Connected Gateway Pack | | | |
|  AC5110MW | Connected Gateway - Wired - 2 Module | 21540 | 1/1/10 |
| Wireless Control Switch | | | |
|  AC5201MW | Classic - 1 Gang - Wireless Switch - 2 Module | 4914 | 1/5/30 |
|  AC5202MW | Classic - 2 Gang - Wireless Switch - 2 Module | 5214 | 1/5/30 |
|  AC5203MW | Classic - 3 Gang - Wireless Switch - 2 Module | 6410 | 1/5/30 |
| Wireless Scenario Control Switch | | | |
|  AC5700MW | Classic - Wireless 4 Scenario Control Switch - 2 Module | 9000 | 1/5/20 |
|  AC5701MW | Classic - Home/Away Wireless Master Switch - 2 Module | 7206 | 1/5/30 |
|  AC5702MW | Classic - Wake Up/Sleep Wireless Scenario Control Switch - 2 Module | 5214 | 1/5/30 |
| IN Wall Wireless Switch | | | |
|  AC5200MW | Classic - In-Wall - Wireless Switch - 1 Module | 6158 | 1/5/20 |
|  AC5501MW | Classic - In Wall Wireless - Fan Control Switch - 1 Module | 8952 | 1/5/20 |
| AC5300MW | Classic - In Wireless - Curtain/Roller Blind Switch - 1 Module | 7104 | 1/5/20 |

* MRP - Maximum Retail Price Inclusive of all taxes including GST.
Red Cat. Nos - New Products

Arteor Advance™ IoT

NEW! Connected Homes-Classic Matt White Mechanism

| Cat.Nos | Description | MRP* ₹ / Unit | Pack |
|--|---|------------------|--------|
| IN Wall Wireless Switch | | | |
|  AC5703MW | Classic - In Wall Wake Up/Sleep Wireless Switch - 1 Module | 7206 | 1/5/20 |
|  AC5704MW | Classic - In Wall Home/Away Wireless Switch - 1 Module | 7206 | 1/5/20 |
| Wireless Batteryless Switch | | | |
|  AC5206MW | Classic - Wireless - Batteryless - 1 Gang - Control Switch - 2 Module | 22226 | 1/10 |
|  AC5207MW | Classic - Wireless - Batteryless - 2 Gang - Control Switch - 2 Module | 25216 | 1/10 |
|  AC5302MW | Classic - Wireless - Batteryless - Curtain/Roller Blind Switch - 2 Module | 18470 | 1/10 |
|  AC5707MW | Classic - Wireless - Batteryless - Home/Away Master Switch - 2 Module | 18370 | 1/10 |
|  AC5708MW | Classic - Wireless - Batteryless - Wake Up/Sleep Scenario Switch - 2 Module | 18736 | 1/10 |
|  AC5705MW | Classic - Wireless - Batteryless - 4 Scenario Switch - 2 Module | 23400 | 1/10 |
| Connected Homes-Classic Matt Titanium Mechanism | | | |
| Connected Light Switches | | | |
|  AC52113MT | Classic - Connected Switch - with Neutral - Wired - 1 Module | 13642 | 1/5/20 |
|  AC52112MT | Classic - Connected Switch Dimmer - with Neutral - 150 Watts - 1 Module | 15660 | 1/5/50 |
| Connected Outlets | | | |
|  AC5412MT | Classic - 16A - Connected Socket Module - 1 Module | 15690 | 1/5/50 |
| Connected Curtain/Roller Blind Switches | | | |
|  AC5310MT | Classic - Connected Curtain/Roller Blind Switch - Wired - 1 Module | 16584 | 1/5/20 |
| Connected Step Fan controller | | | |
|  AC5510MT | Classic - Connected Step Fan Controller - with Neutral -100W - 2 Module | 11484 | 1/10 |

Bold Cat.Nos are products normally available with Legrand (India) Stockists. Cat.Nos that are not bold - delivery within 4 - 8 weeks from the date of order. Bold packing quantity is our mandatory packing. Orders to be placed by Legrand (India) Stockist in multiples of the same.

Arteor Advance™ IoT

NEW! Connected Homes-Classic Matt Titanium Mechanism



| Cat.Nos | Description | MRP* ₹ / Unit | Pack |
|---------|-------------|------------------|------|
|---------|-------------|------------------|------|

Connected Gateway Pack

| | | | |
|-----------------|--------------------------------------|-------|--------|
| AC5110MT | Connected Gateway - Wired - 2 Module | 24764 | 1/1/10 |
|-----------------|--------------------------------------|-------|--------|

Wireless Control Switch

| | | | |
|-----------------|---|------|--------|
| AC5201MT | Classic - 1 Gang - Wireless Switch - 2 Module | 5654 | 1/5/30 |
| AC5202MT | Classic - 2 Gang - Wireless Switch - 2 Module | 5998 | 1/5/30 |
| AC5203MT | Classic - 3 Gang - Wireless Switch - 2 Module | 7374 | 1/5/30 |

Wireless Scenario Control Switch

| | | | |
|-----------------|---|-------|--------|
| AC5700MT | Classic - Wireless 4 Scenario Control Switch - 2 Module | 10352 | 1/5/20 |
| AC5701MT | Classic - Home/Away Wireless Master Switch - 2 Module | 8292 | 1/5/30 |
| AC5702MT | Classic - Wake Up/Sleep Wireless Scenario Control Switch - 2 Module | 5998 | 1/5/30 |

IN Wall Wireless Switch

| | | | |
|-----------------|---|-------|--------|
| AC5200MT | Classic - In Wall - Wireless Switch - 1 Module | 7154 | 1/5/20 |
| AC5501MT | Classic - In Wall - Wireless - Fan Control Switch - 1 Module | 10294 | 1/5/20 |
| AC5300MT | Classic - In Wall - Wireless - Curtain/Roller Blind Switch - 1 Module | 8170 | 1/5/20 |
| AC5703MT | Classic - In Wall Wake Up/Sleep Wireless Switch - 1 Module | 8292 | 1/5/20 |
| AC5704MT | Classic - In Wall Home/Away Wireless Switch - 1 Module | 8292 | 1/5/20 |

Wireless Batteryless Switch

| | | | |
|-----------------|---|-------|------|
| AC5206MT | Classic - Wireless - Batteryless - 1 Gang - Control Switch - 2 Module | 25562 | 1/10 |
| AC5207MT | Classic - Wireless - Batteryless - 2 Gang - Control Switch - 2 Module | 29002 | 1/10 |
| AC5302MT | Classic - Wireless - Batteryless - Curtain/Roller Blind Switch - 2 Module | 21238 | 1/10 |
| AC5707MT | Classic - Wireless - Batteryless - Home/Away Master Switch - 2 Module | 21128 | 1/10 |
| AC5708MT | Classic - Wireless - Batteryless - Wake Up/Sleep Scenario Switch - 2 Module | 21546 | 1/10 |
| AC5705MT | Classic - Wireless - Batteryless - 4 Scenario Switch - 2 Module | 26910 | 1/10 |

* MRP - Maximum Retail Price Inclusive of all taxes including GST.
Red Cat. Nos - New Products

Arteor Advance™ IoT

NEW! Connected Homes-Classic Matt Black Mechanism



| Cat.Nos | Description | MRP* ₹ / Unit | Pack |
|---------|-------------|------------------|------|
|---------|-------------|------------------|------|

Connected Light Switches

| | | | |
|------------------|---|-------|--------|
| AC52113MB | Classic - Connected Switch - with Neutral - Wired - 1 Module | 13642 | 1/5/20 |
| AC52112MB | Classic - Connected Switch Dimmer - with Neutral - 150 Watts - 1 Module | 15660 | 1/5/50 |

Connected Outlets

| | | | |
|-----------------|--|-------|--------|
| AC5412MB | Classic - 16A - Connected Socket Module - 1 Module | 15690 | 1/5/50 |
|-----------------|--|-------|--------|

Connected Curtain/Roller Blind Switches

| | | | |
|-----------------|--|-------|--------|
| AC5310MB | Classic - Connected Curtain/Roller Blind Switch - Wired - 1 Module | 16584 | 1/5/20 |
|-----------------|--|-------|--------|

Connected Step Fan controller

| | | | |
|-----------------|--|-------|------|
| AC5510MB | Classic - Connected Step Fan Controller - with Neutral - 100W - 2 Module | 11484 | 1/10 |
|-----------------|--|-------|------|

Connected Gateway Pack

| | | | |
|-----------------|--------------------------------------|-------|--------|
| AC5110MB | Connected Gateway - Wired - 2 Module | 24764 | 1/1/10 |
|-----------------|--------------------------------------|-------|--------|

Wireless Control Switch

| | | | |
|-----------------|---|------|--------|
| AC5201MB | Classic - 1 Gang - Wireless Switch - 2 Module | 5654 | 1/5/30 |
| AC5202MB | Classic - 2 Gang - Wireless Switch - 2 Module | 5998 | 1/5/30 |
| AC5203MB | Classic - 3 Gang - Wireless Switch - 2 Module | 7374 | 1/5/30 |

Wireless Scenario Control Switch

| | | | |
|-----------------|---|-------|--------|
| AC5700MB | Classic - Wireless 4 Scenario Control Switch - 2 Module | 10352 | 1/5/20 |
| AC5701MB | Classic - Home/Away Wireless Master Switch - 2 Module | 8292 | 1/5/30 |
| AC5702MB | Classic - Wake Up/Sleep Wireless Scenario Control Switch - 2 Module | 5998 | 1/5/30 |

IN Wall Wireless Switch

| | | | |
|-----------------|---|-------|--------|
| AC5200MB | Classic - In Wall - Wireless Switch - 1 Module | 7154 | 1/5/20 |
| AC5501MB | Classic - In Wall - Wireless - Fan Control Switch - 1 Module | 10294 | 1/5/20 |
| AC5300MB | Classic - In Wall - Wireless - Curtain/Roller Blind Switch - 1 Module | 8170 | 1/5/20 |
| AC5703MB | Classic - In Wall Wake Up/Sleep Wireless Switch - 1 Module | 8292 | 1/5/20 |

Bold Cat.Nos are products normally available with Legrand (India) Stockists. Cat.Nos that are not bold - delivery within 4 - 8 weeks from the date of order. Bold packing quantity is our mandatory packing. Orders to be placed by Legrand (India) Stockist in multiples of the same.

Arteor Advance™ IoT

NEW! Connected Homes-Classic Matt Black Mechanism

| Cat.Nos | Description | MRP* ₹ / Unit | Pack |
|---------|-------------|------------------|------|
|---------|-------------|------------------|------|

IN Wall Wireless Switch

| | | | |
|-----------------|--|------|--------|
| AC5704MB | Classic - In Wall Home/Away Wireless Switch - 1 Module | 8292 | 1/5/20 |
|-----------------|--|------|--------|

Wireless Batteryless Switch

| | | | |
|-----------------|---|-------|------|
| AC5206MB | Classic - Wireless - Batteryless - 1 Gang - Control Switch - 2 Module | 25562 | 1/10 |
| AC5207MB | Classic - Wireless - Batteryless - 2 Gang - Control Switch - 2 Module | 29002 | 1/10 |
| AC5302MB | Classic - Wireless - Batteryless - Curtain/Roller Blind Switch - 2 Module | 21238 | 1/10 |
| AC5707MB | Classic - Wireless - Batteryless - Home/Away Master Switch - 2 Module | 21128 | 1/10 |
| AC5708MB | Classic - Wireless - Batteryless - Wake Up/Sleep Scenario Switch - 2 Module | 21546 | 1/10 |
| AC5705MB | Classic - Wireless - Batteryless - 4 Scenario Switch - 2 Module | 26910 | 1/10 |

Connected Homes-Elite Matt White Mechanism

Connected light Switches

| | | | |
|------------------|---|-------|--------|
| AA52113MW | Elite - Connected Switch - with Neutral - Wired - 1 Module | 13636 | 1/5/20 |
| AA52112MW | Elite - Connected Switch Dimmer - with Neutral - 150 Watts - 1 Module | 15660 | 1/5/50 |

Connected Curtain/Roller Blind Switches

| | | | |
|-----------------|--|-------|--------|
| AA5310MW | Elite - Connected Curtain/Roller Blind Switch - Wired - 1 Module | 15866 | 1/5/20 |
|-----------------|--|-------|--------|

Connected Step Fan controller

| | | | |
|-----------------|--|-------|------|
| AA5510MW | Elite - Connected Step Fan Controller - with Neutral - 100W - 2 Module | 11988 | 1/10 |
|-----------------|--|-------|------|

Connected Gateway Pack

| | | | |
|-----------------|--------------------------------------|-------|--------|
| AC5110MW | Connected Gateway - Wired - 2 Module | 21540 | 1/1/10 |
|-----------------|--------------------------------------|-------|--------|

Wireless Control Switch

| | | | |
|-----------------|---|------|--------|
| AA5201MW | Elite - 1 Gang - Wireless Switch - 2 Module | 5900 | 1/5/30 |
| AA5202MW | Elite - 2 Gang - Wireless Switch - 2 Module | 6258 | 1/5/20 |

Arteor Advance™ IoT

NEW! Connected Homes-Elite Matt White Mechanism

| Cat.Nos | Description | MRP* ₹ / Unit | Pack |
|---------|-------------|------------------|------|
|---------|-------------|------------------|------|

Wireless Control Switch

| | | | |
|-----------------|---|------|--------|
| AA5203MW | Elite - 3 Gang - Wireless Switch - 2 Module | 7694 | 1/5/30 |
|-----------------|---|------|--------|

Wireless Scenario Control Switch

| | | | |
|-----------------|---|-------|--------|
| AA5700MW | Elite - Wireless 4 Scenario Control Switch - 2 Module | 10348 | 1/5/30 |
| AA5701MW | Elite - Home/Away Wireless Master Switch - 2 Module | 7926 | 1/5/30 |
| AA5702MW | Elite - Wake Up/Sleep Wireless Scenario Control Switch - 2 Module | 6258 | 1/5/30 |

IN Wall Wireless Switch

| | | | |
|-----------------|---|-------|--------|
| AA5200MW | Elite - In-Wall - Wireless Control Switch - 1 Module | 6774 | 1/5/20 |
| AA5501MW | Elite - In Wall - Wireless - Fan Control Switch - 1 Module | 10744 | 1/5/20 |
| AA5300MW | Elite - In Wall - Wireless - Curtain/Roller Blind Switch - 1 Module | 7816 | 1/5/20 |
| AA5703MW | Elite - In Wall Wake Up/Sleep Wireless Switch - 1 Module | 7926 | 1/5/20 |
| AA5704MW | Elite - In Wall Home/Away Wireless Switch - 1 Module | 7926 | 1/5/20 |

Wireless Batteryless Switch

| | | | |
|-----------------|---|-------|------|
| AA5206MW | Elite - Wireless - Batteryless - 1 Gang - Control Switch - 2 Module | 26672 | 1/10 |
| AA5207MW | Elite - Wireless - Batteryless - 2 Gang - Control Switch - 2 Module | 30260 | 1/10 |
| AA5302MW | Elite - Wireless - Batteryless - Curtain/Roller Blind Switch - 2 Module | 22168 | 1/10 |
| AA5707MW | Elite - Wireless - Batteryless - Home/Away Master Switch - 2 Module | 22046 | 1/10 |
| AA5708MW | Elite - Wireless - Batteryless - Wake Up/Sleep Scenario Switch - 2 Module | 22482 | 1/10 |
| AA5705MW | Elite - Wireless - Batteryless - 4 Scenario Switch - 2 Module | 28078 | 1/10 |

* MRP - Maximum Retail Price Inclusive of all taxes including GST.
Red Cat. Nos - New Products

Bold Cat.Nos are products normally available with Legrand (India) Stockists. Cat.Nos that are not bold - delivery within 4 - 8 weeks from the date of order. Bold packing quantity is our mandatory packing. Orders to be placed by Legrand (India) Stockist in multiples of the same.

Arteor Advance™ IoT

NEW! Connected Homes-Elite Matt Titanium Mechanism



| Cat.Nos | Description | MRP* ₹ / Unit | Pack |
|---------|-------------|------------------|------|
|---------|-------------|------------------|------|

Connected Light Switches

| | | | |
|------------------|---|-------|--------|
| AA52113MT | Elite - Connected Switch - with Neutral - Wired - 1 Module | 13912 | 1/5/20 |
| AA52112MT | Elite - Connected Switch Dimmer - with Neutral - 150 Watts - 1 Module | 15818 | 1/5/50 |

Connected Curtain/Roller Blind Switches

| | | | |
|-----------------|--|-------|--------|
| AA5310MT | Elite - Connected Curtain/Roller Blind Switch - Wired - 1 Module | 16746 | 1/5/20 |
|-----------------|--|-------|--------|

Connected Step Fan controller

| | | | |
|-----------------|---|-------|------|
| AA5510MT | Elite - Connected Step Fan Controller - with Neutral -100W - 2 Module | 13782 | 1/10 |
|-----------------|---|-------|------|

Connected Gateway Pack

| | | | |
|-----------------|--------------------------------------|-------|--------|
| AC5110MT | Connected Gateway - Wired - 2 Module | 24764 | 1/1/10 |
|-----------------|--------------------------------------|-------|--------|

Wireless Control Switch

| | | | |
|-----------------|---|------|--------|
| AA5201MT | Elite - 1 Gang - Wireless Switch - 2 Module | 6786 | 1/5/30 |
| AA5202MT | Elite - 2 Gang - Wireless Switch - 2 Module | 7196 | 1/5/20 |
| AA5203MT | Elite - 3 Gang - Wireless Switch - 2 Module | 8848 | 1/5/20 |

Wireless Scenario Control Switch

| | | | |
|-----------------|---|-------|--------|
| AA5700MT | Elite - Wireless 4 Scenario Control Switch - 2 Module | 11384 | 1/5/30 |
| AA5701MT | Elite - Home/Away Wireless Master Switch - 2 Module | 8374 | 1/5/30 |
| AA5702MT | Elite - Wake Up/Sleep Wireless Scenario Control Switch - 2 Module | 7196 | 1/5/30 |

IN Wall Wireless Switch

| | | | |
|-----------------|---|-------|--------|
| AA5200MT | Elite - In-Wall - Wireless Control Switch - 1 Module | 7224 | 1/5/20 |
| AA5501MT | Elite - In Wall - Wireless - Fan Control Switch - 1 Module | 12356 | 1/5/20 |
| AA5300MT | Elite - In Wall - Wireless - Curtain/Roller Blind Switch - 1 Module | 8250 | 1/5/20 |
| AA5703MT | Elite - In Wall Wake Up/Sleep Wireless Switch - 1 Module | 8374 | 1/5/20 |
| AA5704MT | Elite - In Wall Home/Away Wireless Switch - 1 Module | 8374 | 1/5/20 |

* MRP - Maximum Retail Price Inclusive of all taxes including GST.
Red Cat. Nos - New Products

Arteor Advance™ IoT

NEW! Connected Homes-Elite Matt Titanium Mechanism



| Cat.Nos | Description | MRP* ₹ / Unit | Pack |
|---------|-------------|------------------|------|
|---------|-------------|------------------|------|

Wireless Batteryless Switch

| | | | |
|-----------------|---|-------|------|
| AA5206MT | Elite - Wireless - Batteryless - 1 Gang - Control Switch - 2 Module | 30676 | 1/10 |
| AA5207MT | Elite - Wireless - Batteryless - 2 Gang - Control Switch - 2 Module | 34802 | 1/10 |
| AA5302MT | Elite - Wireless - Batteryless - Curtain/Roller Blind Switch - 2 Module | 25486 | 1/10 |
| AA5707MT | Elite - Wireless - Batteryless - Home/Away Master Switch - 2 Module | 25354 | 1/10 |
| AA5708MT | Elite - Wireless - Batteryless - Wake Up/Sleep Scenario Switch - 2 Module | 25854 | 1/10 |
| AA5705MT | Elite - Wireless - Batteryless - 4 Scenario Switch - 2 Module | 32292 | 1/10 |

Connected Homes-Elite Matt Black Mechanism

Connected Light Switches

| | | | |
|------------------|---|-------|--------|
| AA52113MB | Elite - Connected Switch - with Neutral - Wired - 1 Module | 13912 | 1/5/20 |
| AA52112MB | Elite - Connected Switch Dimmer - with Neutral - 150 Watts - 1 Module | 15818 | 1/5/50 |

Connected Curtain/Roller Blind Switches

| | | | |
|-----------------|--|-------|--------|
| AA5310MB | Elite - Connected Curtain/Roller Blind Switch - Wired - 1 Module | 16584 | 1/5/20 |
|-----------------|--|-------|--------|

Connected Step Fan controller

| | | | |
|-----------------|---|-------|------|
| AA5510MB | Elite - Connected Step Fan Controller - with Neutral -100W - 2 Module | 13782 | 1/10 |
|-----------------|---|-------|------|

Connected Gateway Pack

| | | | |
|-----------------|--------------------------------------|-------|--------|
| AC5110MB | Connected Gateway - Wired - 2 Module | 24764 | 1/1/10 |
|-----------------|--------------------------------------|-------|--------|











Wireless Control Switch

| | | | |
|-----------------|--|------|--------|
| AA5201MB | Elite- 1 Gang - Wireless Switch - 2 Module | 6786 | 1/5/30 |
| AA5202MB | Elite- 2 Gang - Wireless Switch - 2 Module | 7196 | 1/5/20 |
| AA5203MB | Elite- 3 Gang - Wireless Switch - 2 Module | 8848 | 1/5/20 |

Bold Cat.Nos are products normally available with Legrand (India) Stockists. Cat.Nos that are not bold - delivery within 4 - 8 weeks from the date of order. Bold packing quantity is our mandatory packing. Orders to be placed by Legrand (India) Stockist in multiples of the same.













Arteor Advance™ IoT

NEW! Connected Homes-Elite Matt Black Mechanism

| Cat.Nos | Description | MRP* ₹ / Unit | Pack |
|--|---|------------------|--------|
| Wireless Scenario Control Switch | | | |
|  AA5700MB | Elite - Wireless 4 Scenario Control Switch - 2 Module | 11384 | 1/5/30 |
|  AA5701MB | Elite - Home/Away Wireless Master Switch - 2 Module | 8374 | 1/5/30 |
|  AA5702MB | Elite - Wake Up/Sleep Wireless Scenario Control Switch - 2 Module | 7196 | 1/5/30 |
| IN Wall Wireless Switch | | | |
|  AA5200MB | Elite - In-Wall - Wireless Control Switch - 1 Module | 7224 | 1/5/20 |
|  AA5501MB | Elite - In Wall - Wireless - Fan Control Switch - 1 Module | 12356 | 1/5/20 |
|  AA5300MB | Elite - In Wall - Wireless - Curtain/Roller Blind Switch - 1 Module | 8250 | 1/5/20 |
|  AA5703MB | Elite - In Wall Wake Up/Sleep Wireless Switch - 1 Module | 8374 | 1/5/20 |
|  AA5704MB | Elite - In Wall Home/Away Wireless Switch - 1 Module | 8374 | 1/5/20 |
| Wireless Batteryless Switch | | | |
|  AA5206MB | Elite - Wireless - Batteryless - 1 Gang - Control Switch - 2 Module | 30676 | 1/10 |
|  AA5207MB | Elite - Wireless - Batteryless - 2 Gang - Control Switch - 2 Module | 34802 | 1/10 |

Arteor Advance™ IoT

NEW! Connected Homes-Elite Matt Black Mechanism

| Cat.Nos | Description | MRP* ₹ / Unit | Pack |
|--|---|------------------|--------|
|  AA5302MB | Elite - Wireless - Batteryless - Curtain/Roller Blind Switch - 2 Module | 25486 | 1/10 |
|  AA5707MB | Elite - Wireless - Batteryless - Home/Away Master Switch - 2 Module | 25354 | 1/10 |
|  AA5708MB | Elite - Wireless - Batteryless - Wake Up/Sleep Scenario Switch - 2 Module | 25854 | 1/10 |
|  AA5705MB | Elite - Wireless - Batteryless - 4 Scenario Switch - 2 Module | 32292 | 1/10 |
| Smart Plug | | | |
|  6793 90 | 6A - Smart Mobile Plug | 10348 | 5/20 |
|  6793 91 | 16A - Smart Mobile Plug | 11146 | 5/20 |
| Micro module switch & Accessories | | | |
|  5742 43 | Connected Micro Module Switch - with Neutral - Black | 9732 | 1/0/22 |
|  0676 97 | Shutter Micromodule | 12624 | 1 |
|  0676 94 | Wireless Switch - On/Off Module for Mechanical Switch - (Auxiliary) - Black | 11810 | 1 |
|  0676 95 | Potable Remote - Black | 15568 | 1 |
| White Cover Plate with Support Frame | | | |
|  AC1200MW | Cover Plate + Frame - 1 Module - Matt White | 510 | 10/100 |
|  AC1201MW | Cover Plate + Frame - 2 Module - Matt White | 528 | 10/100 |

| Product Category | | Classic Collection | | | Décor Collection | | | Pure Metal | |
|--|---------|--------------------|-----------------|-----------------|--------------------|--------------------|-------------------------------|--------------------|----------------------|
| | | Matt Titanium (MT) | Matt White (MW) | Matt Black (MB) | Frosted White (FW) | Frosted Black (FB) | Brushed Stainless Steel (BSS) | Midnight Blue (NB) | Solid Aluminium (SA) |
| Gateway | Classic | Yes | Yes | Yes | Yes | Yes | Yes | Yes | Yes |
| Wired On/Off Switch Dimmer Switch Curtain Switch | Classic | Yes | Yes | Yes | Yes | Yes | Yes | Yes | Yes |
| | Elite | | | | Yes | Yes | | | |
| Socket Module | Classic | Yes | Yes | Yes | Yes | Yes | Yes | Yes | Yes |
| Fan Module | Classic | Yes | Yes | Yes | Yes | Yes | Yes | Yes | Yes |
| | Elite | | | | Yes | Yes | | | |

* MRP - Maximum Retail Price Inclusive of all taxes including GST.
Red Cat. Nos - New Products

Bold Cat.Nos are products normally available with Legrand (India) Stockists. Cat.Nos that are not bold - delivery within 4 - 8 weeks from the date of order. Bold packing quantity is our mandatory packing. Orders to be placed by Legrand (India) Stockist in multiples of the same.

Arteor Advance™ IoT

Classic- Cover Plate with Support Frame

Wireless Batteryless Switch

| Product Category | | Classic Collection | | | Décor Collection | | | Pure Metal | |
|------------------|---------|--------------------|-----------------|-----------------|--------------------|--------------------|-------------------------------|--------------------|----------------------|
| | | Matt Titanium (MT) | Matt White (MW) | Matt Black (MB) | Frosted White (FW) | Frosted Black (FB) | Brushed Stainless Steel (BSS) | Midnight Blue (NB) | Solid Aluminium (SA) |
| 1 Gang Switch | Classic | Yes | Yes | Yes | Yes | Yes | Yes | Yes | Yes |
| | Elite | | | | Yes | Yes | Yes | Yes | Yes |
| 2 Gang Switch | Classic | Yes | Yes | Yes | Yes | Yes | Yes | Yes | Yes |
| | Elite | | | | Yes | Yes | Yes | Yes | Yes |
| Curtain Switch | Classic | Yes | Yes | Yes | Yes | Yes | Yes | Yes | Yes |
| | Elite | | | | Yes | Yes | Yes | Yes | Yes |
| Scenario Switch | Classic | Yes | Yes | Yes | Yes | Yes | Yes | Yes | Yes |
| | Elite | | | | Yes | Yes | Yes | Yes | Yes |

Wireless Switches

| Product Category | | Classic Collection | | | Décor Collection | | | Pure Metal | |
|------------------|---------|--------------------|-----------------|-----------------|--------------------|--------------------|-------------------------------|--------------------|----------------------|
| | | Matt Titanium (MT) | Matt White (MW) | Matt Black (MB) | Frosted White (FW) | Frosted Black (FB) | Brushed Stainless Steel (BSS) | Midnight Blue (NB) | Solid Aluminium (SA) |
| 1 Gang Switch | Classic | Yes | Yes | Yes | Yes | Yes | Yes | Yes | Yes |
| | Elite | | | | Yes | Yes | | | |
| 2 Gang Switch | Classic | Yes | Yes | Yes | Yes | Yes | Yes | Yes | Yes |
| | Elite | | | | Yes | Yes | | | |
| 3 Gang Switch | Classic | Yes | Yes | Yes | Yes | Yes | Yes | Yes | Yes |
| | Elite | | | | Yes | Yes | | | |
| Curtain Switch | Classic | Yes | Yes | Yes | Yes | Yes | Yes | Yes | Yes |
| | Elite | | | | Yes | Yes | | | |
| Scenario Switch | Classic | Yes | Yes | Yes | Yes | Yes | Yes | Yes | Yes |
| | Elite | | | | Yes | Yes | | | |

Classic- Cover Plate with Support Frame

| Cat.Nos | Description | MRP* ₹ / Unit | Pack |
|---|---|------------------|--------|
| White Cover Plate with Support Frame | | | |
| AC1202MW | Cover Plate + Frame - 3 Module - Matt White | 612 | 10/100 |
| AC1203MW | Cover Plate + Frame - 4 Module - Matt White | 700 | 5/50 |
| AC1205MW | Cover Plate + Frame - 6 Module - Matt White | 964 | 5/30 |
| AC1207MW | Cover Plate + Frame - 8 Module - Matt White | 1140 | 5/30 |
| AC1208MW | Cover Plate + Frame - 2*4 Module - Matt White | 1666 | 2/20 |
| AC1212MW | Cover Plate + Frame - 9 Module - Matt White | 1768 | 5/30 |

* MRP - Maximum Retail Price Inclusive of all taxes including GST.
Red Cat. Nos - New Products















Classic- Cover Plate with Support Frame

| Cat.Nos | Description | MRP* ₹ / Unit | Pack |
|--|---|------------------|--------|
| White Cover Plate with Support Frame | | | |
| AC1210MW | Cover Plate + Frame - 2*6 Module - Matt White | 2216 | 2/16 |
| AC1213MW | Cover Plate + Frame - 2*8 Module - Matt White | 2436 | 2/16 |
| AC1211MW | Cover Plate + Frame - 3*6 Module - Matt White | 2872 | 2/12 |
| Matt Black Cover Plate with Support Frame | | | |
| AC1200MB | Cover Plate + Frame - 1 Module - Matt Black | 614 | 10/100 |
| AC1201MB | Cover Plate + Frame - 2 Module - Matt Black | 648 | 10/100 |
| AC1202MB | Cover Plate + Frame - 3 Module - Matt Black | 686 | 10/100 |
| AC1203MB | Cover Plate + Frame - 4 Module - Matt Black | 778 | 5/50 |

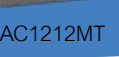
Bold Cat.Nos are products normally available with Legrand (India) Stockists. Cat.Nos that are not bold - delivery within 4 - 8 weeks from the date of order. Bold packing quantity is our mandatory packing. Orders to be placed by Legrand (India) Stockist in multiples of the same.

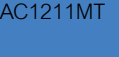
Arteor Advance™ IoT

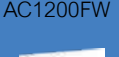
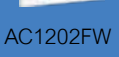











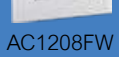

NEW! Classic- Cover Plate with Support Frame

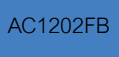
| Cat.Nos | Description | MRP* ₹ / Unit | Pack |
|--|--|------------------|--------|
| Matt Black Cover Plate with Support Frame | | | |
|  AC1207MB | Cover Plate + Frame - 6 Module - Matt Black | 1330 | 5/30 |
|  AC1207MB | Cover Plate + Frame - 8 Module - Matt Black | 1476 | 5/30 |
|  AC1208MB | Cover Plate + Frame - 2*4 Module - Matt Black | 1872 | 2/20 |
|  AC1212MB | Cover Plate + Frame - 9 Module - Matt Black | 1986 | 5/30 |
|  AC1210MB | Cover Plate + Frame - 2*6 Module - Matt Black | 2430 | 2/16 |
|  AC1213MB | Cover Plate + Frame - 2*8 Module - Matt Black | 2760 | 2/16 |
|  AC1211MB | Cover Plate + Frame - 3*6 Module - Matt Black | 3226 | 2/12 |
| Matt Titanium Cover Plate with Support Frame | | | |
|  AC1200MT | Cover Plate + Frame - 1 Module - Matt Titanium | 614 | 10/100 |
|  AC1202MT | Cover Plate + Frame - 2 Module - Matt Titanium | 648 | 10/100 |
|  AC1202MT | Cover Plate + Frame - 3 Module - Matt Titanium | 686 | 10/100 |
|  AC1203MT | Cover Plate + Frame - 4 Module - Matt Titanium | 778 | 5/50 |
|  AC1205MT | Cover Plate + Frame - 6 Module - Matt Titanium | 1330 | 5/30 |
|  AC1207MT | Cover Plate + Frame - 8 Module - Matt Titanium | 1476 | 5/30 |
|  AC1208MT | Cover Plate + Frame - 2*4 Module - Matt Titanium | 1872 | 2/20 |
|  AC1212MT | Cover Plate + Frame - 9 Module - Matt Titanium | 1986 | 5/30 |
|  AC1210MT | Cover Plate + Frame - 2*6 Module - Matt Titanium | 2430 | 2/16 |
|  AC1213MT | Cover Plate + Frame - 2*8 Module - Matt Titanium | 2760 | 2/16 |
|  AC1211MT | Cover Plate + Frame - 3*6 Module - Matt Titanium | 3226 | 2/12 |
| Frosted White Cover Plate with Support Frame | | | |
| AC1200FW | Cover Plate + Frame - 1 Module - Frosted White | 788 | 1/5/30 |
| AC1201FW | Cover Plate + Frame - 2 Module - Frosted White | 842 | 1/5/30 |
| AC1202FW | Cover Plate + Frame - 3 Module - Frosted White | 902 | 1/20 |

* MRP - Maximum Retail Price Inclusive of all taxes including GST.
Red Cat. Nos - New Products

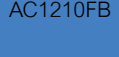
Arteor Advance™ IoT

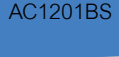
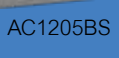
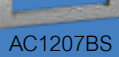
NEW! Classic- Cover Plate with Support Frame

| Cat.Nos | Description | MRP* ₹ / Unit | Pack |
|--|--|------------------|--------|
| Frosted White Cover Plate with Support Frame | | | |
|  AC1203FW | Cover Plate + Frame - 4 Module - Frosted White | 960 | 1/20 |
|  AC1205FW | Cover Plate + Frame - 6 Module - Frosted White | 1746 | 1/5/30 |
|  AC1207FW | Cover Plate + Frame - 8 Module - Frosted White | 1922 | 1/5/30 |
|  AC1208FW | Cover Plate + Frame - 2*4 Module - Frosted White | 2482 | 1/10 |
|  AC1210FW | Cover Plate + Frame - 2*6 Module - Frosted White | 2998 | 1/16 |
| Frosted Black Cover Plate with Support Frame | | | |
|  AC1200FB | Cover Plate + Frame - 1 Module - Frosted Black | 788 | 1/5/30 |
|  AC1201FB | Cover Plate + Frame - 2 Module - Frosted Black | 842 | 1/5/30 |
|  AC1202FB | Cover Plate + Frame - 3 Module - Frosted Black | 902 | 1/20 |
|  AC1203FB | Cover Plate + Frame - 4 Module - Frosted Black | 960 | 1/20 |
|  AC1205FB | Cover Plate + Frame - 6 Module - Frosted Black | 1746 | 1/5/30 |
|  AC1207FB | Cover Plate + Frame - 8 Module - Frosted Black | 1922 | 1/5/30 |
|  AC1208FB | Cover Plate + Frame - 2*4 Module - Frosted Black | 2482 | 1/10 |
|  AC1210FB | Cover Plate + Frame - 2*6 Module - Frosted Black | 2998 | 1/16 |
| Brushed Stainless Steel Cover Plate with Support Frame | | | |
|  AC1200BS | Cover Plate + Frame - 1 Module - Brushed Stainless Steel | 3596 | 1/5/30 |
|  AC1201BS | Cover Plate + Frame - 2 Module - Brushed Stainless Steel | 3844 | 1/5/30 |
|  AC1202BS | Cover Plate + Frame - 3 Module - Brushed Stainless Steel | 4134 | 1/20 |
|  AC1203BS | Cover Plate + Frame - 4 Module - Brushed Stainless Steel | 4388 | 1/20 |
|  AC1205BS | Cover Plate + Frame - 6 Module - Brushed Stainless Steel | 7986 | 1/5/30 |
| AC1207BS | Cover Plate + Frame - 8 Module - Brushed Stainless Steel | 8782 | 1/5/30 |

Bold Cat.Nos are products normally available with Legrand (India) Stockists. Cat.Nos that are not bold - delivery within 4 - 8 weeks from the date of order. Bold packing quantity is our mandatory packing. Orders to be placed by Legrand (India) Stockist in multiples of the same.

Arteor Advance™ IoT

NEW! Elite- Cover Plate with Support Frame

| Cat.Nos | Description | MRP* ₹ / Unit | Pack |
|---|--|------------------|------|
| Brushed Stainless Steel Cover Plate with Support Frame | | | |
| AC1208BS | Cover Plate + Frame - 2*4 Module - Brushed Stainless Steel | 11100 | 1/10 |
| AC1210BS | Cover Plate + Frame - 2*6 Module - Brushed Stainless Steel | 13682 | 1/16 |

Solid Aluminium Cover Plate with Support Frame

| | | | |
|-----------------|--|-------|--------|
| AC1200SA | Cover Plate + Frame - 1 Module - Solid Aluminium | 5134 | 1/5/30 |
| AC1201SA | Cover Plate + Frame - 2 Module - Solid Aluminium | 5494 | 1/5/30 |
| AC1202SA | Cover Plate + Frame - 3 Module - Solid Aluminium | 5908 | 1/20 |
| AC1203SA | Cover Plate + Frame - 4 Module - Solid Aluminium | 6270 | 1/20 |
| AC1205SA | Cover Plate + Frame - 6 Module - Solid Aluminium | 11408 | 1/5/30 |
| AC1207SA | Cover Plate + Frame - 8 Module - Solid Aluminium | 12544 | 1/5/30 |
| AC1208SA | Cover Plate + Frame - 2*4 Module - Solid Aluminium | 15856 | 1/10 |
| AC1210SA | Cover Plate + Frame - 2*6 Module - Solid Aluminium | 19546 | 1/16 |

Midnight Blue Cover Plate with Support Frame

| | | | |
|-----------------|--|-------|--------|
| AC1200NB | Cover Plate + Frame - 1 Module - Midnight Blue | 5134 | 1/5/30 |
| AC1201NB | Cover Plate + Frame - 2 Module - Midnight Blue | 5494 | 1/5/30 |
| AC1202NB | Cover Plate + Frame - 3 Module - Midnight Blue | 5908 | 1/20 |
| AC1203NB | Cover Plate + Frame - 4 Module - Midnight Blue | 6270 | 1/20 |
| AC1205NB | Cover Plate + Frame - 6 Module - Midnight Blue | 11408 | 1/5/30 |
| AC1207NB | Cover Plate + Frame - 8 Module - Midnight Blue | 12544 | 1/5/30 |
| AC1208NB | Cover Plate + Frame - 2*4 Module - Midnight Blue | 15856 | 1/10 |
| AC1210NB | Cover Plate + Frame - 2*6 Module - Midnight Blue | 19546 | 1/16 |

Arteor Advance™ IoT

NEW! Elite- Cover Plate with Support Frame

| Cat.Nos | Description | MRP* ₹ / Unit | Pack |
|--|--|------------------|--------|
| Round Plates with Support Frame | | | |
| AA1202MW | Cover Plate + Frame - 2 Module - Round - Matt White | 658 | 10/100 |
| AA1202MB | Cover Plate + Frame - 2 Module - Round - Matt Black | 808 | 10/100 |
| AA1202MT | Cover Plate + Frame - 2 Module - Round - Matt Titanium | 808 | 10/100 |

Frosted White Cover Plate with Support Frame

| | | | |
|-------------------|--|------|--------|
| AA1200FW | Cover Plate + Frame - 1 Module - 1 x Elite - Frosted White | 984 | 1/5/30 |
| AA1201FW | Cover Plate + Frame - 2 Module - 2 x Elite - Frosted White | 1054 | 1/5/30 |
| AA1202FW | Cover Plate + Frame - 2 Module - Round - Frosted White | 1054 | 1/5/30 |
| AA1203FW | Cover Plate + Frame - 3 Module - 3 x Elite - Frosted White | 1130 | 1/20 |
| AA1204FW** | Cover Plate + Frame - 4 Module - 4 x Elite - Frosted White | 1248 | 1/5/30 |

Frosted Black Cover Plate with Support Frame

| | | | |
|-------------------|--|------|--------|
| AA1200FB | Cover Plate + Frame - 1 Module - 1 x Elite - Frosted Black | 984 | 1/5/30 |
| AA1201FB | Cover Plate + Frame - 2 Module - 2 x Elite - Frosted Black | 1054 | 1/5/30 |
| AA1202FB | Cover Plate + Frame - 2 Module - Round - Frosted Black | 1054 | 1/5/30 |
| AA1203FB | Cover Plate + Frame - 3 Module - 3 x Elite - Frosted Black | 1130 | 1/20 |
| AA1204FB** | Cover Plate + Frame - 4 Module - 4 x Elite - Frosted Black | 1248 | 1/5/30 |

Brushed Stainless Steel Cover Plate with Support Frame

| | | | |
|-----------------|--|------|--------|
| AA1200BS | Cover Plate + Frame - 1 Module - 1 x Elite - Brushed Stainless Steel | 4492 | 1/5/30 |
| AA1201BS | Cover Plate + Frame - 2 Module - 2 x Elite - Brushed Stainless Steel | 4806 | 1/5/30 |



AC1208BS



AC1210BS



AC1200SA



AC1201SA



AC1202SA



AC1203SA



AC1205SA



AC1207SA



AC1208SA



AC1210SA

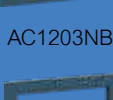

AC1200NB



AC1201NB

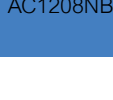

AC1202NB



AC1203NB

AC1205NB

AC1207NB

AC1208NB



AA1200FW



AA1201FW



AA1202FW



AA1203FW



AA1200FB



AA1201FB



AA1202FB



AA1203FB



AA1200BS

* MRP - Maximum Retail Price Inclusive of all taxes including GST.

**Lead Time : 8 - 10 weeks after order booking

Red Cat. Nos - New Products

Bold Cat.Nos are products normally available with Legrand (India) Stockists. Cat.Nos that are not bold - delivery within 4 - 8 weeks from the date of order. Bold packing quantity is our mandatory packing. Orders to be placed by Legrand (India) Stockist in multiples of the same.

NEW!

| Cat.Nos | Description | MRP* ₹ / Unit | Pack |
|---|--|------------------|--------|
| Brushed Stainless Steel Cover Plate with Support Frame | | | |
| AA1202BS | Cover Plate + Frame - 2 Module - Round - Brushed Stainless Steel | 4806 | 1/5/30 |
| AA1203BS | Cover Plate + Frame - 3 Module - 3 x Elite - Brushed Stainless Steel | 5170 | 1/20 |

Solid Aluminium Cover Plate with Support Frame

| | | | |
|-------------------|--|------|--------|
| AA1200SA | Cover Plate + Frame - 1 Module - 1 x Elite - Solid Aluminium | 6418 | 1/5/30 |
| AA1201SA | Cover Plate + Frame - 2 Module - 2 x Elite - Solid Aluminium | 6870 | 1/5/30 |
| AA1202SA | Cover Plate + Frame - 2 Module - Round - Solid Aluminium | 6870 | 1/5/30 |
| AA1203SA | Cover Plate + Frame - 3 Module - 3 x Elite - Solid Aluminium | 7386 | 1/20 |
| AA1204SA** | Cover Plate + Frame - 4 Module - 4 x Elite - Solid Aluminium | 8150 | 1/5/30 |

Elite Midnight Blue Cover Plate with Support Frame

| | | | |
|-------------------|--|------|--------|
| AA1200NB | Cover Plate + Frame - 1 Module - 1 x Elite - Midnight Blue | 6418 | 1/5/30 |
| AA1201NB | Cover Plate + Frame - 2 Module - 2 x Elite - Midnight Blue | 6870 | 1/5/30 |
| AA1202NB | Cover Plate + Frame - 2 Module - Round - Midnight Blue | 6870 | 1/5/30 |
| AA1203NB | Cover Plate + Frame - 3 Module - 3 x Elite - Midnight Blue | 7386 | 1/20 |
| AA1204NB** | Cover Plate + Frame - 4 Module - 4 x Elite - Midnight Blue | 8150 | 1/5/30 |

Elite Frosted White Cover Plate with Support Frame

| | | | |
|-----------------|---|------|--------|
| AB1208FW | Cover Plate + Frame - 4 Module - 2 x Classic + 2 x Elite - Frosted White | 1248 | 1/20 |
| AB1203FW | Cover Plate + Frame - 6 Module - 3 x Classic + 2 x Elite - Frosted White | 2270 | 1/5/30 |

NEW!

| Cat.Nos | Description | MRP* ₹ / Unit | Pack |
|---|---|------------------|--------|
| Elite Frosted White Cover Plate with Support Frame | | | |
| AB1205FW | Cover Plate + Frame - 6 Module - 4 x Classic + 1 x Elite - Frosted White | 2270 | 1/5/30 |
| AB1202FW | Cover Plate + Frame - 6 Module - 3 x Classic + Round - Frosted White | 2270 | 1/5/30 |
| AB1207FW | Cover Plate + Frame - 8 Module - 5 x Classic + Round - Frosted White | 2498 | 1/5/30 |

Elite Frosted Black Cover Plate with Support Frame

| | | | |
|-----------------|---|------|--------|
| AB1208FB | Cover Plate + Frame - 4 Module - 2 x Classic + 2 x Elite - Frosted Black | 1248 | 1/20 |
| AB1203FB | Cover Plate + Frame - 6 Module - 3 x Classic + 2 x Elite - Frosted Black | 2270 | 1/5/30 |
| AB1205FB | Cover Plate + Frame - 6 Module - 4 x Classic + 1 x Elite - Frosted Black | 2270 | 1/5/30 |
| AB1202FB | Cover Plate + Frame - 6 Module - 3 x Classic + Round - Frosted Black | 2270 | 1/5/30 |
| AB1207FB | Cover Plate + Frame - 8 Module - 5 x Classic + Round - Frosted Black | 2498 | 1/5/30 |

Elite Brushed Stainless Steel Cover Plate with Support Frame

| | | | |
|-----------------|---|-------|--------|
| AA1200BS | Cover Plate + Frame - 1 Module - 1 x Elite - Brushed Stainless Steel | 5704 | 1/5/30 |
| AA1201BS | Cover Plate + Frame - 2 Module - 2 x Elite - Brushed Stainless Steel | 10382 | 1/5/30 |
| AA1202BS | Cover Plate + Frame - 2 Module - Round - Brushed Stainless Steel | 10382 | 1/5/30 |
| AA1203BS | Cover Plate + Frame - 3 Module - 3 x Elite - Brushed Stainless Steel | 10382 | 1/20 |
| AA1204BS | Cover Plate + Frame - 4 Module - 4 x Elite - Brushed Stainless Steel | 11418 | 1/5/30 |

* MRP - Maximum Retail Price Inclusive of all taxes including GST.
**Lead Time : 8 - 10 weeks after order booking
Red Cat. Nos - New Products

Bold Cat.Nos are products normally available with Legrand (India) Stockists.
Cat.Nos that are not bold - delivery within 4 - 8 weeks from the date of order.
Bold packing quantity is our mandatory packing. Orders to be placed by
Legrand (India) Stockist in multiples of the same.

Arteor Advance™ IoT

NEW! Accessories- Metal Flush Boxes

| Cat.Nos | Description | MRP* ₹ / Unit | Pack |
|---------|-------------|------------------|------|
|---------|-------------|------------------|------|

Elite Solid Aluminium Cover Plate with Support Frame

| | | | |
|-----------------|---|-------|--------|
| AB1208SA | Cover Plate + Frame - 4 Module - 2 x Classic + 2 x Elite - Solid Aluminium | 8150 | 1/20 |
| AB1203SA | Cover Plate + Frame - 6 Module - 3 x Classic + 2 x Elite - Solid Aluminium | 14832 | 1/5/30 |
| AB1205SA | Cover Plate + Frame - 6 Module - 4 x Classic + 1 x Elite - Solid Aluminium | 14832 | 1/5/30 |
| AB1202SA | Cover Plate + Frame - 6 Module - 3 x Classic + Round - Solid Aluminium | 14832 | 1/5/30 |
| AB1207SA | Cover Plate + Frame - 8 Module - 5 x Classic + Round - Solid Aluminium | 16306 | 1/5/30 |

Elite Midnight Blue Cover Plate with Support Frame

| | | | |
|-----------------|---|-------|--------|
| AB1208NB | Cover Plate + Frame - 4 Module - 2 x Classic + 2 x Elite - Midnight Blue | 8150 | 1/20 |
| AB1203NB | Cover Plate + Frame - 6 Module - 3 x Classic + 2 x Elite - Midnight Blue | 14832 | 1/5/30 |
| AB1205NB | Cover Plate + Frame - 6 Module - 4 x Classic + 1 x Elite - Midnight Blue | 14832 | 1/5/30 |
| AB1202NB | Cover Plate + Frame - 6 Module - 3 x Classic + Round - Midnight Blue | 14832 | 1/5/30 |
| AB1207NB | Cover Plate + Frame - 8 Module - 5 x Classic + Round - Midnight Blue | 16306 | 1/5/30 |

Accessory

| | | | |
|----------------|---|-----|------|
| 0648 71 | Pack of 3*4 Extra Removable Stickers for Fixing A Wireless Control | 806 | 1/25 |
|----------------|---|-----|------|

Metal Flush Boxes

| | | | |
|----------------|---------------------------------|-----|----|
| 6890 07 | Metal Flush Box - 1/2 Module | 170 | 40 |
| 6890 08 | Metal Flush Box - 3 Module | 170 | 40 |
| 6890 09 | Metal Flush Box - 4 Module | 226 | 40 |

* MRP - Maximum Retail Price Inclusive of all taxes including GST.
Red Cat. Nos - New Products

Arteor Advance™ IoT

NEW! Accessories- Metal Flush Boxes

| Cat.Nos | Description | MRP* ₹ / Unit | Pack |
|---------|-------------|------------------|------|
|---------|-------------|------------------|------|

Metal Flush Boxes

| | | | |
|----------------|---------------------------------|-----|----|
| 6890 10 | Metal Flush Box - 6 Module | 358 | 40 |
| 6890 42 | Metal Flush Box - 8 Module | 416 | 40 |
| 6890 31 | Metal Flush Box - 4*2 Module | 414 | 20 |
| 6890 29 | Metal Flush Box - 9 Module | 490 | 20 |
| 6890 11 | Metal Flush Box -12 Module | 624 | 10 |
| 6890 13 | Metal Flush Box -16 Module | 720 | 10 |
| 6890 12 | Metal Flush Box - 18 Module | 788 | 10 |

Bold Cat.Nos are products normally available with Legrand (India) Stockists.
Cat.Nos that are not bold - delivery within 4 - 8 weeks from the date of order.
Bold packing quantity is our mandatory packing. Orders to be placed by
Legrand (India) Stockist in multiples of the same.

ARTEOR™

Versatile Wiring Devices for Global Projects



Arteor™ is a modular wiring device range designed to meet the needs of residential, commercial, and hospitality projects worldwide. Combining ergonomic design, premium finishes, and advanced control options, it supports everything from standard electrical installations to connected IoT and BUS-based automation systems.

Features

- Ergonomic round and square rocker designs available in refined finishes
- Extensive finish palette with over 16 colours
- Extensive mechanism range with switches, dimmers, USB chargers, and data outlets
- Smart-ready solutions supporting automation, hotel controls, and scenario-based switching

Benefits

- Supports global projects with compliance to IEC & BS
- Enhances interiors with premium materials and contemporary design options
- Supports modern connectivity needs with integrated charging and data solutions
- Enables scalable control from simple wiring setups to advanced automation systems



Scan to know more about the product.





Round rocker White



Round rocker Magnesium



Round rocker Champagne



Square rocker White

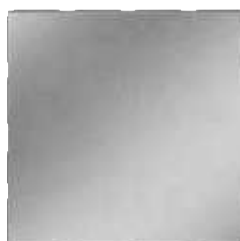

Square rocker Magnesium



Square rocker Champagne



ARTEOR™

Versatility & Modularity for Unrivalled Flexibility

Arteor™ is a modular range offering maximum flexibility in terms of installation and configuration.

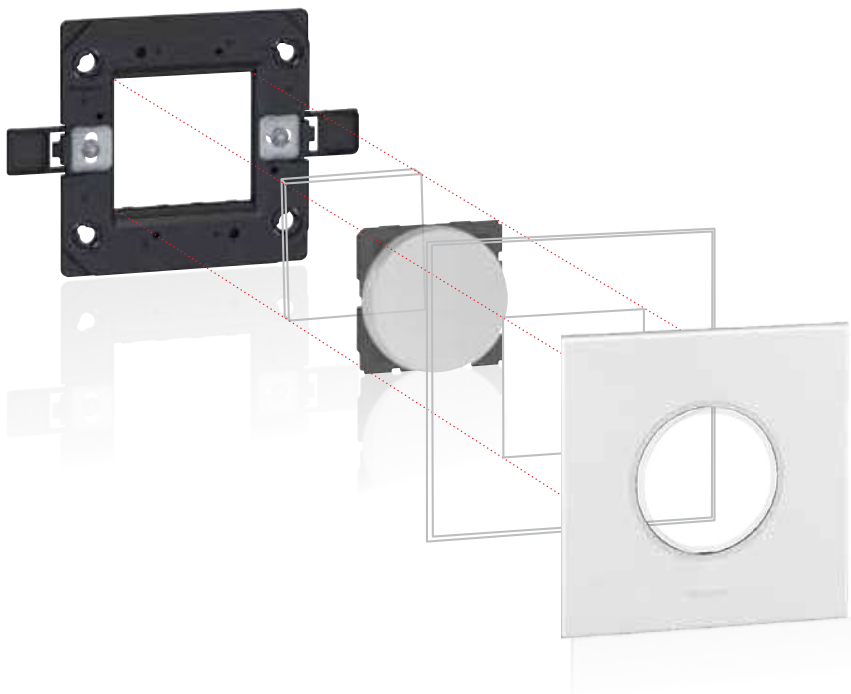

Features that set ARTEOR™ apart



- ① Finger-proof terminals for IP 20 protection against accidental contact.
- ② Captive "never to loose" screws



- ① Tunnel terminals preventing screwdrivers from slipping.
- ② Laser marking on mechanisms. Arrow showing the correct orientation of the mechanism.
- ③ The latest IS 3854 : 2023.



Sockets with ISI* mark, conforming to IS 1293. Fan regulator with ISI* mark, conforming to IS 11037.



Fully shrouded internal mechanism under the rocker preventing visibility of sparks.



- ① Stripping templates on sockets for stripping off exact length of insulation.



- ① Sockets are shuttered for child's safety against electric shocks.



Possibility of weather proofing mechanisms using Plexo IP 55 and IP 66 boxes.



For switches with LED lamps, life of LED is 50000 burning hours. Consumes power (0.76W) next to NIL.

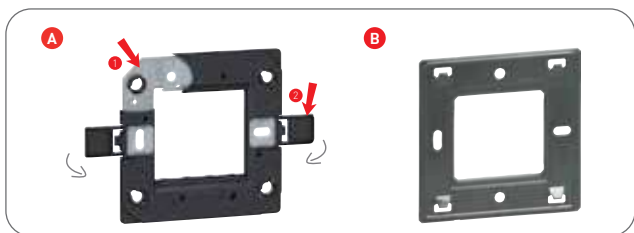

A. For all high end plates Metal frame providing solid support to base. Bi-material frame - electrical safety IP20. Screw caps can be closed once the support frame is installed, ensuring total insulation.



2x2 way switch - 3 controls possible in 2 module plate. In round and square design possible.



Mechanisms compatible with DLP trunking systems, columns, floor boxes and VDI installations.

ARTEOR™

The Ideal Solution, Always & Everywhere

Its versatility makes Arteor™ the ideal choice for every kind of project, anywhere in the world at any installation level. Arteor™ suits any requirement in terms of design and function for every kind of building, from residential to commercial.



TV socket



Skirting light

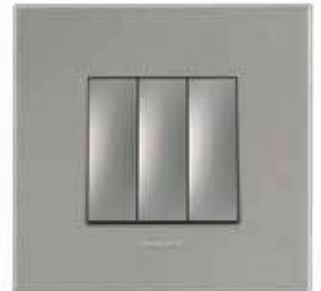

1-way switch - 3 gang



USB Charger
Type C+C - 65W





6AX switch*



Skirting light



USB charger
Type C+C - 30W



Triple RCA socket



Time delay switch

* Switch compatible with LED light

Modern Home



ARTEOR™

Office & Hotel Solutions

Offices and collective spaces require specific solutions and maximum flexibility: lighting adapted to each situation (meeting, conference, etc.), access security, comprehensive multimedia connections. The Arteor™ range meets all these expectations with perfect adaptability.



Automatic switch



6A 1 way switch



USB socket



Preterminated HDMI sockets



Female HD15 + Jack



USB Charger
Type C - 45W



From hotel room door to the beside table, Arteor™ provides all the solutions for the specific need of today's hotel industry. Comfort that extends to the hotel's communal areas, whether dedicated to the relaxation or work. The multitude of small details, gives the comfort feeling of being at home to the traveller.



Data sockets



4-Scenario touch control



S-Video socket



Keycard switch



External unit



Desk and Entrance Light



Bed light & curtain switch



Internal Unit



ARTEOR™

A Rich Choice of Finishes

NEUTRAL

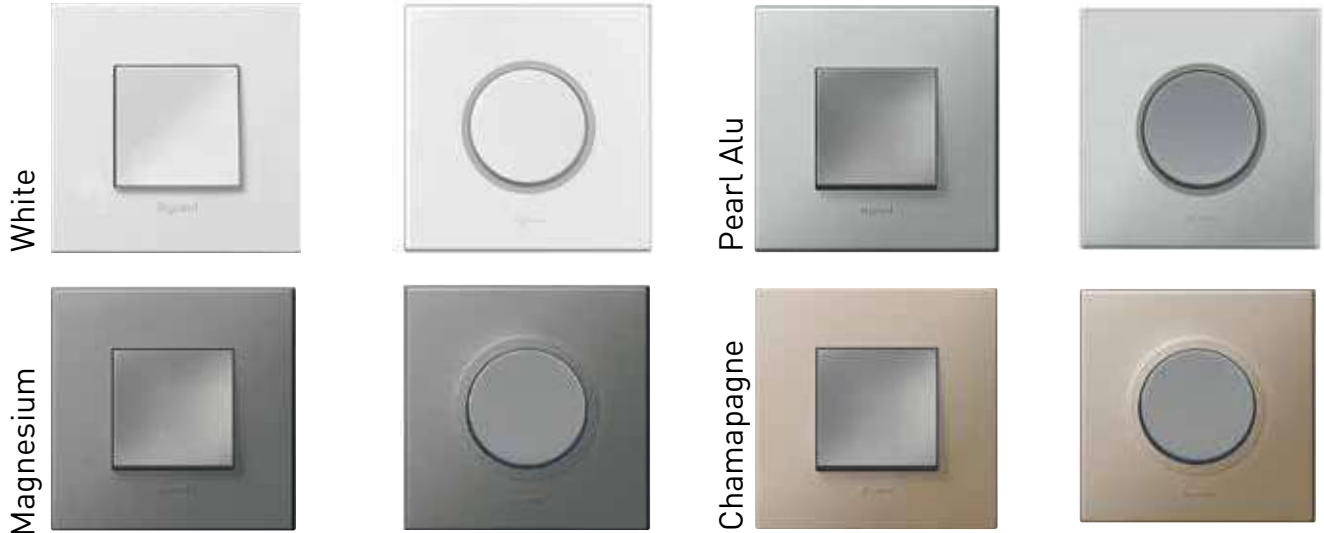

MIRROR



GRAPHIC

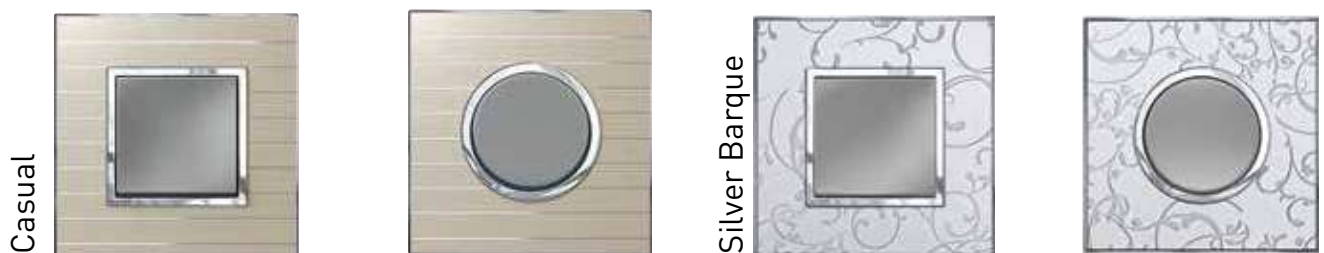

METAL



Graphite



Dark Bronze



Green Apple



Dark Barque



WOOD

Grey Oak



SIGNATURE

Cube



ARTEOR™

MyHOME

Elegant and Intuitive Home Automation

Arteor™ MyHOME offers elegant home automation that combines beautiful design with simple touch control for lighting, blinds, HVAC, and more through intuitive touchscreens and smartphone apps.

Features

- Full-range touchscreen interface for home control
- Smartphone app with dedicated icons for lights, temperature, blinds, and scenarios
- Seamless integration across electrical, wiring, and building infrastructure
- Versatile design suitable for rural, industrial, and digital environments

Benefits

- Simplifies home management with intuitive touch and mobile control
- Enhances aesthetics while providing comprehensive automation
- Reduces complexity through unified interface for all systems
- Adapts to diverse architectural and lifestyle settings

Scan to know more about the product.



THE FINISHING TOUCH



| Cat.Nos | Description | MRP* ₹ / Unit | Pack |
|---------|-------------|------------------|------|
|---------|-------------|------------------|------|

Switches – 6A - 230V AC

| | | | |
|---------|--|-----|----------|
| 5734 00 | 6A - Switch - SP - 1 Way - 1 Module | 232 | 1/20/200 |
| 5734 01 | 6A - Switch - SP - 1 Way - with Indicator - 1 Module | 432 | 1/20/200 |
| 5734 02 | 6A - Switch - SP - 2 Way - 1 Module | 382 | 1/20/200 |
| 5734 03 | 6A - Switch - SP - 2 Way - with Indicator - 1 Module | 540 | 1/20/200 |

Switches – 10A - 230V AC

| | | | |
|---------|--|------|----------|
| 5734 50 | 10A - Switch - SP - 1 Way - 2 Module | 456 | 1/10/100 |
| 5734 51 | 10A - Switch - SP - 2 Way - 2 Module | 538 | 1/10/100 |
| 5720 37 | 10A - Switch - SP - 2 Way - with Indicator & Label Holder - 2 Module | 2552 | 5/50 |
| 5720 38 | 10A - Intermediate Switch - 230V AC - 2 Module | 3054 | 10/100 |

Switches – 20A - 230V AC

| | | | |
|---------|--|------|----------|
| 5734 10 | 20A - Switch - SP - 1 Way - 1 Module | 520 | 1/20/200 |
| 5734 52 | 20A - Switch - SP - 1 Way - 2 Module | 620 | 1/10/100 |
| 5720 63 | 20A - Switch - SP - 1 Way - with Indicator - 1 Module | 536 | 1/20/200 |
| 5734 11 | 20A - Switch - SP - 2 Way - with Indicator - 1 Module | 750 | 1/20/200 |
| 5720 42 | 20A - Switch - SP - 2 Way - with Indicator - 2 Module | 816 | 10/100 |
| 5720 43 | 20A - Switch - 3 Gang - 1 Way - 2 Module | 1464 | 10/100 |
| 5720 44 | 20A - Switch - 3 Gang - 2*2 Way + 1*1 Way - 2 Module | 1604 | 10/100 |
| 5734 54 | 20A - Switch - DP - 1 Way - with Indicator - 2 Module | 1154 | 1/10/100 |
| 5720 49 | 20A - Switch - DP - 1 Way - with Indicator & Water Heater Marking - 2 Module | 1210 | 10/100 |

Accessory for Switch with Indicator

| | | | |
|---------|--|----|------|
| 5738 06 | LED for Switch - with Indicator (Blue) | 94 | 5/50 |
|---------|--|----|------|

Switches – 25A - 230V AC

| | | | |
|---------|--|-----|----------|
| 5734 17 | 25A - Switch - 1 Way - with Indicator - 1 Module | 696 | 1/20/200 |
|---------|--|-----|----------|

| Cat.Nos | Description | MRP* ₹ / Unit | Pack |
|---------|-------------|------------------|------|
|---------|-------------|------------------|------|

Switches – 32A / 40A - 230V AC

| | | | |
|---------|---|------|--------|
| 5734 12 | 32A - Switch - DP - 1 Way - with Indicator - 2 Module | 1646 | 10/100 |
| 5735 30 | 40A - Switch - DP - 1 Way - with Indicator - fits on 1/2 Module Box | 1896 | 1/5/20 |

Push Button – 6A - 230V AC

| | | | |
|---------|---|-----|----------|
| 5734 13 | 6A - Bell Push - SP - 1 Way - 1 Module | 418 | 1/20/200 |
| 5734 59 | 6A - Bell Push - SP - 1 Way - 2 Module | 590 | 1/10/100 |
| 5734 04 | 6A - Push Button - SP - 1 Way - 1 Module | 444 | 1/20/200 |
| 5734 05 | 6A - Push Button - SP - 1 Way - with Indicator - 1 Module | 560 | 1/20/200 |
| 5734 14 | 6A - Bell Push - SP - 1 Way - with Indicator - 1 Module | 556 | 1/20/200 |
| 5734 60 | 6A - Bell Push - SP - 1 Way - with Indicator - 2 Module | 792 | 1/10/100 |

Electric Roller Blinds Control

| | | | |
|---------|---|------|----------|
| 5722 20 | Double Switch for Electric Shutter - 2 Module | 1024 | 1/10/100 |
|---------|---|------|----------|

Dimmers & Fan Regulators

| | | | |
|---------|---|------|----------|
| 5734 62 | Light Dimmer - 60 to 400 Watts - 2 Module | 1720 | 1/10/100 |
| 5734 16 | Fan Step Regulator - 100 Watts - ISI - 1 Module | 1416 | 1/5/50 |
| 5734 63 | Fan Step Regulator - 100 Watts - ISI - 2 Module | 1746 | 1/10/100 |
| 5734 69 | Fan Step Regulator - 120 Watts - ISI - 2 Module (for 48 & 56" Fans) | 1868 | 1/10/100 |
| 5734 68 | Fan Step Regulator - for Energy Saving Fans - 2 Module | 1864 | 1/10/100 |
| 5736 53 | Fan Regulator - 8 Steps - 100 Watts - ISI - 2 Module | 1666 | 1/10/100 |

* MRP - Maximum Retail Price Inclusive of all taxes including GST.

Bold Cat.Nos are products normally available with Legrand (India) Stockists. **Cat.Nos** that are not bold - delivery within 4 - 8 weeks from the date of order. **Bold packing quantity** is our mandatory packing. Orders to be placed by Legrand (India) Stockist in multiples of the same.

Arteor™ Square White Mechanism

| Cat.Nos | Description | MRP* ₹ / Unit | Pack |
|---------|-------------|------------------|------|
|---------|-------------|------------------|------|

Indian Standard Sockets

| | | | |
|---------|---|------|----------|
| 5734 24 | 6A - Socket - with Shutter - 3 Pin - ISI - 2 Module | 356 | 1/20/200 |
| 5734 71 | 6/16A - Socket - with Shutter - 3 Pin - Indian - ISI - 2 Module | 722 | 1/10/100 |
| 5734 67 | 6/16A - Socket - with Shutter - 3 Pin - Indian - ISI - 3 Module | 864 | 1/5/50 |
| 5735 10 | 16A - Socket Shutter with Switch - 3 Pin - 2P+E - Indian - 3 Module | 2018 | 5/50 |

Energy Plugs

| | | | |
|---------|------------|-----|----------|
| 5738 86 | 6A - Plug | 170 | 1/10/100 |
| 5738 88 | 16A - Plug | 228 | 1/10/100 |

USB Chargers (IS13252 (Part 1) / IEC 60950-1)

| | | | |
|---------------------|---|-------|----------|
| 5734 41 | USB Charger - 1500mA - Type A - 1 Module | 2722 | 1/5/50 |
| 5716 80 | USB Charger - 3000mA/15 Watts - Type A - 1 Module | 3206 | 1/10/150 |
| 5716 84 | USB Charger - 3000mA/15 Watts - Type A + A - 1 Module | 3626 | 1/10/150 |
| 5716 88 | USB Charger - 3000mA/15 Watts - Type A + C - 1 Module | 4040 | 1/10/150 |
| 5716 92 | USB Charger - 3000mA/15 Watts - Type C + C - 1 Module | 4526 | 1/10/150 |
| 5716 96 | USB Charger - Power Delivery - 20 Watts - Type C - 1 Module | 6194 | 1/10/150 |
| 5734 81 | USB Charger - Power Delivery - 30 Watts - Type C + C - 2 Module | 9268 | 1/20 |
| 5754 81 | USB Charger - Power Delivery - 45 Watts - Type C - 2 Module | 11962 | 1/20 |
| NEW! 5754 94 | USB Charger - Power Delivery - 65 Watts - Type C + C - 3 Module | 14650 | 1/20 |

Data & Voice

| | | | |
|---------|---|------|----------|
| 5734 27 | Telephone Socket - Double RJ11 - 1 Module | 642 | 1/20/200 |
| 5734 26 | Telephone Socket - RJ11 - with Shutter - 1 Module | 374 | 1/20/200 |
| 5734 29 | Information Socket - RJ45 - Cat 5E - UTP - 1 Module | 739 | 1/20/200 |
| 5734 75 | Information Socket - RJ45 - Cat 5E - UTP - 2 Module | 788 | 1/10/100 |
| 5734 28 | Information Socket - RJ45 - Cat 6 - UTP - 1 Module | 1127 | 1/20/200 |
| 5734 74 | Information Socket - RJ45 - Cat 6 - UTP - 2 Module | 1184 | 1/10/100 |

* MRP - Maximum Retail Price Inclusive of all taxes including GST.

^Coming Soon.

Red Cat. Nos - New Products

Arteor™ Square White Mechanism

| Cat.Nos | Description | MRP* ₹ / Unit | Pack |
|---------|-------------|------------------|------|
|---------|-------------|------------------|------|

Tv Sockets

| | | | |
|---------|---------------------------------|-----|----------|
| 5734 25 | TV Co - axial Socket - 1 Module | 390 | 1/20/200 |
|---------|---------------------------------|-----|----------|

Electronic Chime

| | | | |
|---------|----------------------------------|-----|----------|
| 5734 43 | Bell Ding Dong - 230V - 2 Module | 686 | 1/10/100 |
|---------|----------------------------------|-----|----------|

Buzzer

| | | | |
|---------|--------------------------|------|----------|
| 5734 42 | Buzzer - 230V - 1 Module | 1822 | 1/20/200 |
|---------|--------------------------|------|----------|

Bell Call Indicator & Register - 6A - 230V AC

| | | | |
|---------|--|------|----------|
| 5734 15 | 6A - Bell Call Indicator - SP - with Register - 1 Way - 1 Module | 2646 | 1/20/200 |
| 5736 06 | Set of Labels for Bell Call Indicator | 704 | 1/5/50 |

Skirting Light

| | | | |
|---------|--|-------|----------|
| 5734 64 | Skirting Light - with LED - 230V - 3 Module | 1420 | 1/10/100 |
| 5722 26 | Skirting Light - with Detector (LED) - 230V - 2 Module | 18570 | 1/20 |

Lighting

| | | | |
|----------------------|--|-----|--------|
| 5724 53 | Over Door Light Unit (Red) - 2 Module | 798 | 10/100 |
| 5722 23 | Over Door Light Unit (White) - 2 Module | 656 | 10/100 |
| NEW! 5735 97^ | Indicator Unit - with Transparent LED - 1 Module | 732 | 10/100 |

Hospitality Function

Hotel "DND & MMR" Functions

| | | | |
|---------|---|------|----------|
| 5734 61 | External DND & MMR Control Unit - with Bell Push - 2 Module | 2840 | 1/5/50 |
| 5734 58 | Internal DND & MMR Control Unit - 2 Module | 2036 | 1/10/100 |

Hotel Keycard Switch

| | | | |
|---------|---|------|-------|
| 5722 44 | 16A - Key Card Switch - 230V - 2 Module | 7752 | 1/10 |
| 5722 59 | Key Fob for Key Card Switch | 2114 | 10/50 |

Shaver Socket

| | | | |
|---------|--|------|---|
| 5721 53 | Shaver Socket - 230V/120 - 230V - with Earth Connector | 8056 | 1 |
|---------|--|------|---|

Bold Cat.Nos are products normally available with Legrand (India) Stockists. Cat.Nos that are not bold - delivery within 4 - 8 weeks from the date of order. Bold packing quantity is our mandatory packing. Orders to be placed by Legrand (India) Stockist in multiples of the same.

Arteor™

Square White Mechanism

| Cat.Nos | Description | MRP* ₹ / Unit | Pack |
|---------|-------------|------------------|------|
|---------|-------------|------------------|------|

Time Switch

| | | | |
|---------|------------------------------|------|------|
| 5720 55 | Time Delay Switch - 2 Module | 9554 | 1/20 |
|---------|------------------------------|------|------|

Audio-Video Sockets

| | | | |
|---------|--|-------|------|
| 5722 72 | Double RCA Socket (Audio) - 1 Module | 6074 | 1/20 |
| 5722 73 | Triple RCA Socket (Audio & Video) - 1 Module | 5448 | 1/20 |
| 5722 74 | Female 3.5mm Jack - 1 Module | 6043 | 1/20 |
| 5722 76 | Female BNC 75 Jack - 1 Module | 6375 | 1/20 |
| 5722 83 | Female XLR Jack - 2 Module | 9372 | 1/20 |
| 5720 97 | Preterminated Sockets Female Hd15 - 1 Module | 8413 | 1 |
| 5720 96 | Preterminated HDMI Socket - 1.4 - 1 Module | 9980 | 1 |
| 5722 84 | Line Dying Down - 100V (25 - 30W) - 2 Module | 15612 | 1 |
| 5722 77 | Male XLR Jack - 2 Module | 8575 | 1/20 |
| 5722 78 | Female 3.5mm Jack - Solder - 1 Module | 4985 | 1/20 |
| 5722 75 | USB Socket - 1 Module | 4695 | 1/20 |
| 5722 88 | Female HD15 + Jack 3.5mm - 2 Module | 6773 | 1/20 |

Cable Outlet

| | | | |
|---------|--|------|----------|
| 5734 80 | 45A - Cable Outlet - 2 Module | 1560 | 5/50 |
| 5734 33 | Cord Outlet - with 8mm Diameter - 1 Module | 494 | 1/20/200 |
| 5734 79 | Standard Cord Outlet - 2 Module | 714 | 10/100 |

Blanking Plate

| | | | |
|---------|--------------------------------------|-----|----------|
| 5734 49 | Blanking Plate - 1 Module | 72 | 1/40/400 |
| 5723 44 | Blanking Plate - 2 Module | 108 | 1/10/100 |
| 5758 10 | Blanking Plate with Frame - 2 Module | 656 | 10/100 |

Mounting Accessories for Panel

| | | | |
|---------|-----------------------------------|-----|----------|
| 5760 15 | Panel Mounting Support - 1 Module | 414 | 1/10/100 |
| 5760 16 | Panel Mounting Support - 2 Module | 440 | 1/10/100 |
| 5760 50 | DIN Rail Support - 2 Module | 522 | 1/10/100 |

Square - Magnesium Mechanism

Switches - 6A - 230V AC

| | | | |
|---------|--|-----|----------|
| 5736 00 | 6A - Switch - SP - 1 Way - 1 Module | 272 | 1/20/200 |
| 5736 01 | 6A - Switch - SP - 1 Way - with Indicator - 1 Module | 492 | 1/20/200 |

Arteor™

Square Magnesium Mechanism

| Cat.Nos | Description | MRP* ₹ / Unit | Pack |
|---------|-------------|------------------|------|
|---------|-------------|------------------|------|

Switches - 6A - 230V AC

| | | | |
|---------|--|-----|----------|
| 5736 02 | 6A - Switch - SP - 2 Way - 1 Module | 444 | 1/20/200 |
| 5736 03 | 6A - Switch - SP - 2 Way - with Indicator - 1 Module | 630 | 1/20/200 |

Switches - 10A - 230V AC

| | | | |
|---------|--|------|----------|
| 5736 50 | 10A - Switch - SP - 1 Way - 2 Module | 488 | 1/10/100 |
| 5736 51 | 10A - Switch - SP - 2 Way - 2 Module | 574 | 1/10/100 |
| 5725 37 | 10A - Switch - SP - 2 Way - with Indicator & Label Holder - 2 Module | 2876 | 1/5/50 |
| 5725 38 | 10A - Intermediate Switch - 230V AC - 2 Module | 3516 | 1/10/100 |

Switches - 20A - 230V AC

| | | | |
|---------|--|------|----------|
| 5736 10 | 20A - Switch - SP - 1 Way - 1 Module | 590 | 1/20/200 |
| 5736 52 | 20A - Switch - SP - 1 Way - 2 Module | 694 | 1/10/100 |
| 5725 63 | 20A - Switch - SP - 1 Way - with Indicator - 1 Module | 620 | 1/20/200 |
| 5736 11 | 20A - Switch - SP - 2 Way - with Indicator - 1 Module | 850 | 1/20/200 |
| 5725 42 | 20A - Switch - SP - 2 Way - with Indicator - 2 Module | 910 | 1/5/50 |
| 5725 43 | 20A - Switch - 3 Gang - 1 Way - 2 Module | 1682 | 1/10/100 |
| 5725 44 | 20A - Switch - 3 Gang - 2*2 Way + 1*1 Way - 2 Module | 1756 | 1/10/100 |
| 5736 54 | 20A - Switch - DP - 1 Way - with Indicator - 2 Module | 1360 | 1/10/100 |
| 5725 49 | 20A - Switch - DP - 1 Way - with Indicator & Water Heater Marking - 2 Module | 1452 | 1/10/100 |

Switches - 25A - 230V AC

| | | | |
|---------|--|-----|----------|
| 5736 17 | 25A - Switch - 1 Way - with Indicator - 1 Module | 782 | 1/20/200 |
|---------|--|-----|----------|

Switches - 32A - 230V AC

| | | | |
|---------|---|------|----------|
| 5736 12 | 32A - Switch - DP - 1 Way - with Indicator - 2 Module | 1896 | 1/10/100 |
|---------|---|------|----------|

Push Button - 6A - 230V AC

| | | | |
|---------|---|-----|----------|
| 5736 13 | 6A - Bell Push - SP - 1 Way - 1 Module | 472 | 1/20/200 |
| 5736 59 | 6A - Bell Push - SP - 1 Way - 2 Module | 674 | 1/10/100 |
| 5736 04 | 6A - Push Button - SP - 1 Way - 1 Module | 490 | 1/20/200 |
| 5736 05 | 6A - Push Button - SP - 1 Way - with Indicator - 1 Module | 654 | 1/20/200 |

* MRP - Maximum Retail Price Inclusive of all taxes including GST.

Bold Cat.Nos are products normally available with Legrand (India) Stockists. Cat.Nos that are not bold - delivery within 4 - 8 weeks from the date of order. Bold packing quantity is our mandatory packing. Orders to be placed by Legrand (India) Stockist in multiples of the same.

Arteor™

Square Magnesium Mechanism

| Cat.Nos | Description | MRP* ₹ / Unit | Pack |
|---------|-------------|------------------|------|
|---------|-------------|------------------|------|

Push Button – 6A - 230V AC

| | | | |
|---------|---|-----|----------|
| 5736 14 | 6A - Bell Push - SP - 1 Way - with Indicator - 1 Module | 650 | 1/20/200 |
| 5736 60 | 6A - Bell Push - SP - 1 Way - with Indicator - 2 Module | 908 | 1/10/100 |

Electric Roller Blinds Control

| | | | |
|---------|---|------|----------|
| 5727 20 | Double Switch for Electric Shutter - 2 Module | 1190 | 1/10/100 |
|---------|---|------|----------|

Dimmers & Fan Regulators

| | | | |
|---------|---|------|----------|
| 5736 62 | Light Dimmer - 60 to 400 Watts - 2 Module | 1986 | 1/10/100 |
| 5736 16 | Fan Step Regulator - 100 Watts - ISI - 1 Module | 1632 | 1/5/50 |
| 5736 63 | Fan Step Regulator - 100 Watts - ISI - 2 Module | 2012 | 1/10/100 |
| 5736 69 | Fan Step Regulator - 120 Watts - ISI - 2 Module (for 48 & 56" Fans) | 2154 | 1/10/100 |
| 5736 68 | Fan Step Regulator - for Energy Saving Fans - 2 Module | 2136 | 1/10/100 |
| 5736 56 | Fan Regulator - 8 Steps - 100 Watts - ISI - 2 Module | 1910 | 1/10/100 |

Indian Standard Sockets

| | | | |
|---------|---|------|----------|
| 5736 24 | 6A - Socket - with Shutter - 3 Pin - ISI - 2 Module | 420 | 1/20/200 |
| 5736 71 | 6/16A - Socket - with Shutter - 3 Pin - Indian - ISI - 2 Module | 824 | 1/10/100 |
| 5736 67 | 6/16A - Socket - with Shutter - 3 Pin - Indian - ISI - 3 Module | 1004 | 1/5/50 |
| 5737 10 | 16A - Socket Shutter with Switch - 3 Pin - 2P+E - Indian - 3 Module | 2320 | 5/50 |

USB Chargers (IS13252 (Part 1) / IEC 60950-1)

| | | | |
|---------|---|------|----------|
| 5734 44 | USB Charger - 1500mA - Type A - 1 Module | 3140 | 1/5/50 |
| 5716 81 | USB Charger - 3000mA/15 Watts - Type A - 1 Module | 3532 | 1/10/150 |

Arteor™

Square Magnesium Mechanism

| Cat.Nos | Description | MRP* ₹ / Unit | Pack |
|---------|-------------|------------------|------|
|---------|-------------|------------------|------|

USB Chargers (IS13252 (Part 1) / IEC 60950-1)

| | | | |
|---------------------|---|-------|----------|
| 5716 85 | USB Charger - 3000mA/15 Watts - Type A + A - 1 Module | 4028 | 1/10/150 |
| 5716 89 | USB Charger - 3000mA/15 Watts - Type A + C - 1 Module | 4620 | 1/10/150 |
| 5716 93 | USB Charger - 3000mA/15 Watts - Type C + C - 1 Module | 5048 | 1/10/150 |
| 5716 97 | USB Charger - Power Delivery - 20 Watts - Type C - 1 Module | 6638 | 1/10/150 |
| 5734 82 | USB Charger - Power Delivery - 30 Watts - Type C + C - 2 Module | 9698 | 1/20 |
| 5754 82 | USB Charger - Power Delivery - 45 Watts - Type C - 2 Module | 12514 | 1/20 |
| NEW! 5754 95 | USB Charger - Power Delivery - 65 Watts - Type C + C - 3 Module | 15328 | 1/20 |

Data & Voice

| | | | |
|---------|---|------|----------|
| 5736 27 | Telephone Socket - Double RJ11 - 1 Module | 742 | 1/20/200 |
| 5736 26 | Telephone Socket - RJ11 - with Shutter - 1 Module | 448 | 1/20/200 |
| 5736 29 | Information Socket - RJ45 - Cat 5E - UTP - 1 Module | 846 | 1/20/200 |
| 5736 28 | Information Socket - RJ45 - Cat 6 - UTP - 1 Module | 1290 | 1/20/200 |
| 5736 74 | Information Socket - RJ45 - Cat 6 - UTP - 2 Module | 1360 | 1/10/100 |

TV Sockets

| | | | |
|---------|---------------------------------|-----|----------|
| 5736 25 | TV Co - axial Socket - 1 Module | 460 | 1/20/200 |
|---------|---------------------------------|-----|----------|

Electronic Chime

| | | | |
|---------|----------------------------------|-----|----------|
| 5736 43 | Bell Ding Dong - 230V - 2 Module | 736 | 1/10/100 |
|---------|----------------------------------|-----|----------|

Buzzer

| | | | |
|---------|--------------------------|------|----------|
| 5736 42 | Buzzer - 230V - 1 Module | 1994 | 1/20/200 |
|---------|--------------------------|------|----------|

Bell Call Indicator & Register - 6A - 230V AC

| | | | |
|---------|--|------|----------|
| 5736 15 | 6A - Bell Call Indicator - SP - with Register - 1 Way - 1 Module | 3042 | 1/20/200 |
|---------|--|------|----------|

* MRP - Maximum Retail Price Inclusive of all taxes including GST.
Red Cat. Nos - New Products

Bold Cat.Nos are products normally available with Legrand (India) Stockists. Cat.Nos that are not bold - delivery within 4 - 8 weeks from the date of order. Bold packing quantity is our mandatory packing. Orders to be placed by Legrand (India) Stockist in multiples of the same.

Arteor™

Square Magnesium Mechanism

| Cat.Nos | Description | MRP* ₹ / Unit | Pack |
|---------|-------------|------------------|------|
|---------|-------------|------------------|------|

Lighting

| | | | |
|---------|--|-------|----------|
| 5735 64 | Skirting Light - with LED - 230V - 3 Module | 1638 | 1/10/100 |
| 5727 26 | Skirting Light - with Detector (LED) - 230V - 2 Module | 21352 | 1/20 |

Hospitality Function

Hotel "DND and MMR " functions

| | | | |
|---------|---|------|----------|
| 5736 61 | External DND & MMR Control Unit - with Bell Push - 2 Module | 3250 | 1/5/50 |
| 5736 58 | Internal DND & MMR Control Unit - 2 Module | 2352 | 1/10/100 |

Hotel Keycard Switch

| | | | |
|---------|---|------|-------|
| 5727 44 | 16A - Key Card Switch - 230V - with Time Delay - 2 Module | 8532 | 1/10 |
| 5727 59 | Key Fob for Key Card Switch | 2934 | 10/50 |

Shaver Socket

| | | | |
|---------|--|------|---|
| 5726 53 | Shaver Socket - 230V/120 - 230V - with Earth Connector | 8870 | 1 |
|---------|--|------|---|

Time Switch

| | | | |
|---------|------------------------------|-------|------|
| 5740 84 | Time Delay Switch - 2 Module | 10574 | 1/20 |
|---------|------------------------------|-------|------|

Audio - Video Connector

| | | | |
|---------|--|-------|------|
| 5727 72 | Double RCA Socket (Audio) - 1 Module | 7564 | 1/20 |
| 5727 73 | Triple RCA Socket (Audio & Video) - 1 Module | 5901 | 1/20 |
| 5727 74 | Female 3.5mm Jack - 1 Module | 6712 | 1/20 |
| 5727 76 | Female BNC 75 Jack - 1 Module | 6528 | 1/20 |
| 5727 83 | Female XLR Jack - 2 Module | 11737 | 1/20 |
| 5725 97 | Preterminated Sockets Female Hd15 - 1 Module | 9255 | 1 |
| 5725 96 | Preterminated HDMI Socket - 1.4 - 1 Module | 10494 | 1 |
| 5727 84 | Line Dying Down - 100V (25 - 30W) - 2 Module | 18788 | 1 |

* MRP - Maximum Retail Price Inclusive of all taxes including GST.

Arteor™

Square Magnesium Mechanism

| Cat.Nos | Description | MRP* ₹ / Unit | Pack |
|---------|-------------|------------------|------|
|---------|-------------|------------------|------|

Audio - Video Connector

| | | | |
|---------|-------------------------------------|------|------|
| 5727 75 | USB Socket - 1 Module | 5245 | 1/20 |
| 5727 88 | Female HD15 + Jack 3.5mm - 2 Module | 7365 | 1/20 |

Blanking Plate

| | | | |
|---------|---------------------------|-----|----------|
| 5736 49 | Blanking Plate - 1 Module | 70 | 1/40/400 |
| 5728 44 | Blanking Plate - 2 Module | 122 | 1/10/100 |

Dedicated Switches

| | | | |
|---------|--|------|----------|
| 5738 02 | 20A - Dedicated Switch - DP - 1 Way - 1 Module - Red | 1366 | 1/10/100 |
|---------|--|------|----------|

Tamper Proof & Dedicated Sockets

| | | | |
|---------|---|------|----------|
| 5738 10 | 16A - Dedicated Socket with Switch - 3 Pin - 2P+E - Indian - 3 Module | 2842 | 1/10/100 |
|---------|---|------|----------|

Square - Champagne Mechanism

Switches - 6A - 230V AC

| | | | |
|---------|--|-----|----------|
| 5748 00 | 6A - Switch - SP - 1 Way - 1 Module | 272 | 1/20/200 |
| 5748 01 | 6A - Switch - SP - 1 Way - with Indicator - 1 Module | 492 | 1/20/200 |
| 5748 02 | 6A - Switch - SP - 2 Way - 1 Module | 444 | 1/20/200 |
| 5748 03 | 6A - Switch - SP - 2 Way - with Indicator - 1 Module | 630 | 1/20/200 |

Switches - 10A - 230V AC

| | | | |
|---------|--|------|----------|
| 5748 04 | 10A - Switch - SP - 1 Way - 2 Module | 488 | 1/10/100 |
| 5748 05 | 10A - Switch - SP - 2 Way - 2 Module | 574 | 1/10/100 |
| 5748 06 | 10A - Switch - SP - 2 Way - with Indicator & Label Holder - 2 Module | 2876 | 1/10/100 |
| 5748 07 | 10A - Intermediate Switch - 230V AC - 2 Module | 3516 | 1/10/100 |

Switches - 20A - 230V AC

| | | | |
|---------|---|-----|----------|
| 5748 08 | 20A - Switch - SP - 1 Way - 1 Module | 590 | 1/20/200 |
| 5748 09 | 20A - Switch - SP - 1 Way - 2 Module | 694 | 1/10/100 |
| 5748 10 | 20A - Switch - SP - 1 Way - with Indicator - 1 Module | 620 | 1/20/200 |
| 5748 11 | 20A - Switch - SP - 2 Way - with Indicator - 1 Module | 850 | 1/20/200 |

Bold Cat.Nos are products normally available with Legrand (India) Stockists. **Cat.Nos** that are not bold - delivery within 4 - 8 weeks from the date of order. **Bold packing quantity** is our mandatory packing. Orders to be placed by Legrand (India) Stockist in multiples of the same.

Arteor™

Square Champagne Mechanism

| Cat.Nos | Description | MRP* ₹ / Unit | Pack |
|---------|-------------|------------------|------|
|---------|-------------|------------------|------|

Switches – 20A - 230V AC

| | | | |
|---------|--|------|----------|
| 5748 12 | 20A - Switch - SP - 2 Way - with Indicator - 2 Module | 910 | 1/10/100 |
| 5748 13 | 20A - Switch - 3 Gang - 1 Way - 2 Module | 1680 | 1/10/100 |
| 5748 14 | 20A - Switch - 3 Gang - 2*2 Way + 1*1 Way - 2 Module | 1756 | 1/10/100 |
| 5748 15 | 20A - Switch - DP - 1 Way - with Indicator - 2 Module | 1360 | 1/10/100 |
| 5748 16 | 20A - Switch - DP - 1 Way - with Indicator & Water Heater Marking - 2 Module | 1452 | 1/10/100 |

Switches – 25A - 230V AC

| | | | |
|---------|--|-----|----------|
| 5748 17 | 25A - Switch - 1 Way - with Indicator - 1 Module | 782 | 1/20/200 |
|---------|--|-----|----------|

Switches – 32A / 40A - 230V AC

| | | | |
|---------|---|------|----------|
| 5748 18 | 32A - Switch - DP - 1 Way - with Indicator - 2 Module | 1896 | 1/10/100 |
| 5748 19 | 40A - Switch - DP - 1 Way - with Indicator - fits on 1/2 Module Box | 2180 | 1/5/20 |

Push Button – 6A - 230V AC

| | | | |
|---------|---|-----|----------|
| 5748 23 | 6A - Bell Push - SP - 1 Way - 1 Module | 472 | 1/20/200 |
| 5748 24 | 6A - Bell Push - SP - 1 Way - 2 Module | 674 | 1/10/100 |
| 5748 21 | 6A - Push Button - SP - 1 Way - 1 Module | 490 | 1/20/200 |
| 5748 22 | 6A - Push Button - SP - 1 Way - with Indicator - 1 Module | 654 | 1/20/200 |
| 5748 25 | 6A - Bell Push - SP - 1 Way - with Indicator - 1 Module | 650 | 1/20/200 |
| 5748 26 | 6A - Bell Push - SP - 1 Way - with Indicator - 2 Module | 908 | 1/10/100 |

Electric Roller Blinds Control

| | | | |
|---------|---|------|----------|
| 5748 20 | Double Switch for Electric Shutter - 2 Module | 1190 | 1/10/100 |
|---------|---|------|----------|

Dimmers & Fan Regulators

| | | | |
|---------|---|------|----------|
| 5748 27 | Light Dimmer - 60 to 400 Watts - 2 Module | 2042 | 10/100 |
| 5748 29 | Fan Step Regulator - 100 Watts - ISI - 1 Module | 1632 | 1/5/50 |
| 5748 30 | Fan Step Regulator - 100 Watts - ISI - 2 Module | 2012 | 1/10/100 |
| 5748 31 | Fan Step Regulator - 120 Watts - ISI - 2 Module (for 48 & 56" Fans) | 2154 | 1/10/100 |
| 5748 32 | Fan Step Regulator - for Energy Saving Fans - 2 Module | 2136 | 1/10/100 |

Arteor™

Square Champagne Mechanism

| Cat.Nos | Description | MRP* ₹ / Unit | Pack |
|---------|-------------|------------------|------|
|---------|-------------|------------------|------|

| | | | |
|---------|--|------|----------|
| 5736 57 | Fan Regulator - 8 Steps - 100 Watts - ISI - 2 Module | 1910 | 1/10/100 |
|---------|--|------|----------|

Indian Standard Sockets

| | | | |
|---------|---|------|----------|
| 5748 84 | 6A - Socket - with Shutter - 3 Pin - ISI - 2 Module | 420 | 1/20/200 |
| 5748 34 | 6/16A - Socket - with Shutter - 3 Pin - Indian - ISI - 2 Module | 824 | 1/10/100 |
| 5748 35 | 6/16A - Socket - with Shutter - 3 Pin - Indian - ISI - 3 Module | 1004 | 1/5/50 |

USB Chargers (IS13252 (part 1) / IEC 60950-1)

| | | | |
|----------------|---|-------|----------|
| 5734 47 | USB Charger - 1500mA - Type A - 1 Module | 3140 | 1/5/50 |
| 5716 82 | USB Charger - 3000mA/15 Watts - Type A - 1 Module | 3532 | 1/10/150 |
| 5716 86 | USB Charger - 3000mA/15 Watts - Type A + A - 1 Module | 4028 | 1/10/150 |
| 5716 90 | USB Charger - 3000mA/15 Watts - Type A + C - 1 Module | 4620 | 1/10/150 |
| 5716 94 | USB Charger - 3000mA/15 Watts - Type C + C - 1 Module | 5048 | 1/10/150 |
| 5716 98 | USB Charger - Power Delivery - 20 Watts - Type C - 1 Module | 6638 | 1/10/150 |
| 5734 83 | USB Charger - Power Delivery - 30 Watts - Type C + C - 2 Module | 9698 | 1/20 |
| 5754 83 | USB Charger - Power Delivery - 45 Watts - Type C - 2 Module | 12514 | 1/20 |
| 5754 96 | USB Charger - Power Delivery - 65 Watts - Type C + C - 3 Module | 15328 | 1/20 |

Data & Voice

| | | | |
|---------|---|------|----------|
| 5748 45 | Telephone Socket - Double RJ11 - 1 Module | 742 | 1/20/200 |
| 5748 46 | Telephone Socket - RJ11 - with Shutter - 1 Module | 448 | 1/20/200 |
| 5748 47 | Information Socket - RJ45 - Cat 5E - UTP - 1 Module | 846 | 1/20/200 |
| 5748 48 | Information Socket - RJ45 - Cat 5E - UTP - 2 Module | 909 | 1/10/100 |
| 5748 49 | Information Socket - RJ45 - Cat 6 - UTP - 1 Module | 1290 | 1/20/200 |
| 5748 50 | Information Socket - RJ45 - Cat 6 - UTP - 2 Module | 1360 | 1/10/100 |

TV Sockets

| | | | |
|---------|---------------------------------|-----|----------|
| 5748 51 | TV Co - axial Socket - 1 Module | 460 | 1/20/200 |
|---------|---------------------------------|-----|----------|

Electronic Chime

| | | | |
|---------|----------------------------------|-----|----------|
| 5748 52 | Bell Ding Dong - 230V - 2 Module | 736 | 1/10/100 |
|---------|----------------------------------|-----|----------|

* MRP - Maximum Retail Price Inclusive of all taxes including GST.
Red Cat. Nos - New Products

Bold Cat.Nos are products normally available with Legrand (India) Stockists. Cat.Nos that are not bold - delivery within 4 - 8 weeks from the date of order. Bold packing quantity is our mandatory packing. Orders to be placed by Legrand (India) Stockist in multiples of the same.

Arteor™

Square Champagne Mechanism

| Cat.Nos | Description | MRP* ₹ / Unit | Pack |
|---------|-------------|------------------|------|
|---------|-------------|------------------|------|

Buzzer

| | | | |
|---------|--------------------------|------|----------|
| 5748 53 | Buzzer - 230V - 1 Module | 1994 | 1/20/200 |
|---------|--------------------------|------|----------|

Bell Call Indicator & Register - 6A - 230V AC

| | | | |
|---------|--|------|----------|
| 5748 54 | 6A - Bell Call Indicator - SP - with Register - 1 Way - 1 Module | 3042 | 1/20/200 |
|---------|--|------|----------|

Lighting

| | | | |
|---------|---|------|----------|
| 5748 55 | Skirting Light - with LED - 230V - 3 Module | 1638 | 1/10/100 |
|---------|---|------|----------|

Hospitality Function

Hotel "DND and MMR" Functions

| | | | |
|---------|---|------|----------|
| 5748 56 | External DND & MMR Control Unit - with Bell Push - 2 Module | 3250 | 1/5/50 |
| 5748 57 | Internal DND & MMR Control Unit - 2 Module | 2352 | 1/10/100 |

Hotel Keycard Switch

| | | | |
|---------|---|------|--------|
| 5748 58 | 16A - Key Card Switch - 230V - with Time Delay - 2 Module | 8410 | 1/0/10 |
| 5727 59 | Key Fob for Key Card Switch | 2934 | 10/50 |

Blanking Plate

| | | | |
|---------|---------------------------|-----|----------|
| 5748 63 | Blanking Plate - 1 Module | 70 | 1/40/400 |
| 5748 64 | Blanking Plate - 2 Module | 122 | 1/10/100 |

Round - White Mechanism

Switches - 6A - 230V AC

| | | | |
|---------|--|-----|----------|
| 5733 00 | 6A - Switch - SP - 1 Way - Left - 1 Module | 346 | 1/20/200 |
| 5733 01 | 6A - Switch - SP - 1 Way - Right - 1 Module | 346 | 1/20/200 |
| 5733 12 | 6A - Switch - SP - 1 Way - Middle - 1 Module | 346 | 1/20/200 |
| 5733 05 | 6A - Switch - SP - 2 Way - Left - 1 Module | 458 | 1/20/200 |
| 5733 06 | 6A - Switch - SP - 2 Way - Right - 1 Module | 458 | 1/20/200 |
| 5733 02 | 6A - Switch - SP - 1 Way - with Indicator - Left - 1 Module | 522 | 1/20/200 |
| 5733 04 | 6A - Switch - SP - 1 Way - with Indicator - Right - 1 Module | 522 | 1/20/200 |

Arteor™

Round White Mechanism

| Cat.Nos | Description | MRP* ₹ / Unit | Pack |
|---------|-------------|------------------|------|
|---------|-------------|------------------|------|

Switches - 6A - 230V AC

| | | | |
|---------|---|-----|----------|
| 5733 03 | 6A - Switch - SP - 1 Way - with Indicator - Middle - 1 Module | 522 | 1/20/200 |
| 5733 07 | 6A - Switch - SP - 2 Way - with Indicator - Left - 1 Module | 652 | 1/20/200 |
| 5733 08 | 6A - Switch - SP - 2 Way - with Indicator - Right - 1 Module | 652 | 1/20/200 |

Switches - 20A - 230V AC

| | | | |
|---------|---|------|----------|
| 5733 20 | 20A - Switch - SP - 1 Way - Left - 1 Module | 626 | 1/20/200 |
| 5733 21 | 20A - Switch - SP - 1 Way - Right - 1 Module | 626 | 1/20/200 |
| 5730 21 | 20A - Switch - SP - 1 Way - Middle - 1 Module | 642 | 1/10/100 |
| 5733 40 | 20A - Switch - SP - 1 Way - 2 Module | 732 | 1/10/100 |
| 5720 64 | 20A - Switch - SP - 1 Way - with Indicator - Left - 1 Module | 648 | 1/20/200 |
| 5720 65 | 20A - Switch - SP - 1 Way - with Indicator - Right - 1 Module | 648 | 1/20/200 |
| 5730 24 | 20A - Switch - SP - 2 Way - Middle - 1 Module | 650 | 1/10/100 |
| 5733 22 | 20A - Switch - SP - 2 Way - with Indicator - Left - 1 Module | 896 | 1/20/200 |
| 5733 23 | 20A - Switch - SP - 2 Way - with Indicator - Right - 1 Module | 896 | 1/20/200 |
| 5730 71 | 20A - Switch - SP - 2 Way - with Indicator - 2 Module | 798 | 1/5/50 |
| 5730 72 | 20A - Switch - 3 Gang - 1 Way - 2 Module | 1754 | 1/10/100 |
| 5730 73 | 20A - Switch - 3 Gang - 2*2 Way + 1*1 Way - 2 Module | 1932 | 1/10/100 |
| 5733 42 | 20A - Switch - DP - 1 Way - with Indicator - 2 Module | 1360 | 1/10/100 |

Switches - 32A - 230V AC

| | | | |
|---------|---|------|----------|
| 5733 26 | 32A - Switch - DP - 1 Way - with Indicator - 2 Module | 1982 | 1/10/100 |
|---------|---|------|----------|

Push Button - 6A - 230V AC

| | | | |
|---------|---|-----|----------|
| 5733 31 | 6A - Bell Push - SP - 1 Way - Right - 1 Module | 490 | 1/20/200 |
| 5733 30 | 6A - Bell Push - SP - 1 Way - Left - 1 Module | 490 | 1/20/200 |
| 5733 46 | 6A - Bell Push - SP - 1 Way - 2 Module | 696 | 1/10/100 |
| 5733 47 | 6A - Bell Push - SP - 1 Way - with Indicator - 2 Module | 946 | 1/10/100 |

Electronic Roller Blinds Control

| | | | |
|---------|---|------|----------|
| 5732 20 | Double Switch For Electric Shutter - 2 Module | 1240 | 1/10/100 |
|---------|---|------|----------|

* MRP - Maximum Retail Price Inclusive of all taxes including GST.

Bold Cat.Nos are products normally available with Legrand (India) Stockists. Cat.Nos that are not bold - delivery within 4 - 8 weeks from the date of order. Bold packing quantity is our mandatory packing. Orders to be placed by Legrand (India) Stockist in multiples of the same.

Arteor™

Round White Mechanism



5730 66

| Cat.Nos | Description | MRP* ₹ / Unit | Pack |
|---------|-------------|------------------|------|
|---------|-------------|------------------|------|

Dimmers & Fan Regulators

| | | | |
|---------|--|------|----------|
| 5730 66 | Light Dimmer - 60 to 400 Watts - 2 Module | 2068 | 1/10/100 |
| 5730 03 | Fan Step Regulator - 100 Watts - ISI - 2 Module | 2096 | 1/10/100 |
| 5730 69 | Fan Step Regulator - 120 Watts - ISI - 2 Module | 2272 | 1/10/100 |
| 5730 04 | Fan Step Regulator - for Energy Saving Fans - 2 Module | 2224 | 1/10/100 |

Indian Standard Sockets

| | | | |
|---------|---|-----|----------|
| 5734 94 | 6A - Socket - with Shutter - 3 Pin - ISI - 2 Module | 748 | 1/20/200 |
|---------|---|-----|----------|

Data & Voice



5723 24

| | | | |
|---------|--|------|--------|
| 5723 24 | Information Socket - RJ45 - Cat 6 - UTP - 2 Module | 1513 | 10/100 |
|---------|--|------|--------|

Hotel "DND & MMR" Functions



5720 74

| | | | |
|---------|---|------|--------|
| 5720 74 | Internal DND & MMR Control Unit - 2 Module | 2848 | 1/5/50 |
| 5720 67 | External DND & MMR Control Unit - with Bell Push - 2 Module | 3578 | 5/40 |

Blanking Plate



5730 87

| | | | |
|---------|---------------------------|-----|----------|
| 5730 87 | Blanking Plate - 2 Module | 124 | 1/10/100 |
|---------|---------------------------|-----|----------|

Round - Magnesium Mechanism

Switches - 6A - 230V AC



5733 50



5733 51



5733 62

| | | | |
|---------|---|-----|----------|
| 5733 50 | 6A - Switch - SP - 1 Way - Left - 1 Module | 400 | 1/20/200 |
| 5733 51 | 6A - Switch - SP - 1 Way - Right - 1 Module | 400 | 1/20/200 |
| 5733 62 | 6A - Switch - SP - 1 Way - Middle - 1 Module | 402 | 1/20/200 |
| 5733 55 | 6A - Switch - SP - 2 Way - Left - 1 Module | 528 | 1/20/200 |
| 5733 56 | 6A - Switch - SP - 2 Way - Right - 1 Module | 528 | 1/20/200 |
| 5733 52 | 6A - Switch - SP - 1 Way - with Indicator - Left - 1 Module | 586 | 1/20/200 |

* MRP - Maximum Retail Price Inclusive of all taxes including GST.

Arteor™

Round Magnesium Mechanism



5733 70



5733 71



5733 72



5733 92



5733 76



5733 81



5733 80

| Cat.Nos | Description | MRP* ₹ / Unit | Pack |
|---------|-------------|------------------|------|
|---------|-------------|------------------|------|

Switches - 6A - 230V AC

| | | | |
|---------|--|-----|----------|
| 5733 54 | 6A - Switch - SP - 1 Way - with Indicator - Right - 1 Module | 586 | 1/20/200 |
| 5733 57 | 6A - Switch - SP - 2 Way - with Indicator - Left - 1 Module | 756 | 1/20/200 |
| 5733 58 | 6A - Switch - SP - 2 Way - with Indicator - Right - 1 Module | 756 | 1/20/200 |

Switches - 20A - 230V AC

| | | | |
|---------|--|------|----------|
| 5733 70 | 20A - Switch - SP - 1 Way - Left - 1 Module | 698 | 1/20/200 |
| 5733 71 | 20A - Switch - SP - 1 Way - Right - 1 Module | 698 | 1/20/200 |
| 5731 21 | 20A - Switch - SP - 1 Way - Middle - 1 Module | 698 | 1/10/100 |
| 5733 90 | 20A - Switch - SP - 1 Way - 2 Module | 830 | 1/10/100 |
| 5725 64 | 20A - Switch - SP - 1 Way - with Indicator - Left - 1 Module | 732 | 1/20/200 |
| 5725 65 | 20A - Switch - SP - 1 Way - with Indicator - Right - 1 Module | 732 | 1/20/200 |
| 5731 24 | 20A - Switch - SP - 2 Way - Middle - 1 Module | 744 | 1/10/100 |
| 5733 72 | 20A - Switch - SP - 2 Way - with Indicator - Left - 1 Module | 1014 | 1/20/200 |
| 5733 73 | 20A - Switch - SP - 2 Way - with Indicator - Right - 1 Module | 1014 | 1/20/200 |
| 5731 71 | 20A - Switch - SP - 2 Way - with Indicator - 2 Module | 962 | 1/5/50 |
| 5731 72 | 20A - Switch - 3 Gang - 1 Way - 2 Module | 2014 | 1/5/50 |
| 5731 73 | 20A - Switch - 3 Gang - 2*2 Way + 1*1 Way - 2 Module | 2124 | 1/5/50 |
| 5733 92 | 20A - Switch - DP - 1 Way - with Indicator - 2 Module | 1572 | 1/10/100 |
| 5731 27 | 20A - Switch - SP - 2 Way - with Indicator - Middle - 1 Module | 1016 | 1/5/50 |

Switches - 32A - 230V AC

| | | | |
|---------|---|------|----------|
| 5733 76 | 32A - Switch - DP - 1 Way - with Indicator - 2 Module | 2270 | 1/10/100 |
|---------|---|------|----------|

Push Button - 6A - 230V AC

| | | | |
|---------|---|------|----------|
| 5733 81 | 6A - Bell Push - SP - 1 Way - Right - 1 Module | 574 | 1/20/200 |
| 5733 80 | 6A - Bell Push - SP - 1 Way - Left - 1 Module | 574 | 1/20/200 |
| 5733 96 | 6A - Bell Push - SP - 1 Way - 2 Module | 816 | 1/10/100 |
| 5733 97 | 6A - Bell Push - SP - 1 Way - with Indicator - 2 Module | 1072 | 1/10/100 |

Bold Cat.Nos are products normally available with Legrand (India) Stockists. Cat.Nos that are not bold - delivery within 4 - 8 weeks from the date of order. Bold packing quantity is our mandatory packing. Orders to be placed by Legrand (India) Stockist in multiples of the same.

Arteor™

Round Magnesium Mechanism

| Cat.Nos | Description | MRP* ₹ / Unit | Pack |
|---------|-------------|------------------|------|
|---------|-------------|------------------|------|

Electronic Roller Blinds Control

| | | | |
|---------|---|------|----------|
| 5737 20 | Double Switch for Electric Shutter - 2 Module | 1434 | 1/10/100 |
|---------|---|------|----------|

Dimmers & Fan Regulators

| | | | |
|---------|--|------|----------|
| 5733 66 | Light Dimmer - 60 to 400 Watts - 2 Module | 2396 | 1/10/100 |
| 5731 03 | Fan Step Regulator - 100 Watts - ISI - 2 Module | 2410 | 1/10/100 |
| 5731 69 | Fan Step Regulator - 120 Watts - ISI - 2 Module | 2598 | 1/10/100 |
| 5731 04 | Fan Step Regulator - for Energy Saving Fans - 2 Module | 2570 | 1/10/100 |



5731 03

Indian Standard Sockets

| | | | |
|---------|---|-----|----------|
| 5736 94 | 6A - Socket - with Shutter - 3 Pin - ISI - 2 Module | 864 | 1/20/200 |
|---------|---|-----|----------|



5728 24

Data & Voice

| | | | |
|---------|--|------|--------|
| 5728 24 | Information Socket - RJ45 - Cat 6 - UTP - 2 Module | 1727 | 10/100 |
|---------|--|------|--------|



5725 74

Hotel "DND and MMR" Functions

| | | | |
|---------|---|------|--------|
| 5725 74 | Internal DND & MMR Control Unit - 2 Module | 3264 | 1/5/50 |
| 5725 67 | External DND & MMR Control Unit - with Bell Push - 2 Module | 3906 | 5/40 |



5725 67

Blanking Plate

| | | | |
|---------|---------------------------|-----|----------|
| 5731 87 | Blanking Plate - 2 Module | 146 | 1/10/100 |
|---------|---------------------------|-----|----------|



5731 87

Round - Champagne Mechanism

Switches - 6A - 230V AC

| | | | |
|---------|---|-----|----------|
| 5749 00 | 6A - Switch - SP - 1 Way - Left - 1 Module | 400 | 1/20/200 |
| 5749 01 | 6A - Switch - SP - 1 Way - Right - 1 Module | 400 | 1/20/200 |
| 5749 02 | 6A - Switch - SP - 1 Way - Middle - 1 Module | 400 | 1/20/200 |
| 5749 03 | 6A - Switch - SP - 2 Way - Left - 1 Module | 528 | 1/20/200 |
| 5749 04 | 6A - Switch - SP - 2 Way - Right - 1 Module | 528 | 1/20/200 |
| 5749 05 | 6A - Switch - SP - 1 Way - with Indicator - Left - 1 Module | 586 | 1/20/200 |
| 5749 06 | 6A - Switch - SP - 1 Way - with Indicator - Right - 1 Module | 586 | 1/20/200 |
| 5749 07 | 6A - Switch - SP - 1 Way - with Indicator - Middle - 1 Module | 586 | 1/20/200 |



5749 00



5749 01



5749 02

Arteor™

Round Champagne Mechanism

| Cat.Nos | Description | MRP* ₹ / Unit | Pack |
|---------|-------------|------------------|------|
|---------|-------------|------------------|------|

| | | | |
|---------|--|-----|----------|
| 5749 08 | 6A - Switch - SP - 2 Way - with Indicator - Left - 1 Module | 756 | 1/20/200 |
| 5749 09 | 6A - Switch - SP - 2 Way - with Indicator - Right - 1 Module | 756 | 1/20/200 |

Switches - 20A - 230V AC

| | | | |
|---------|---|------|----------|
| 5749 10 | 20A - Switch - SP - 1 Way - Left - 1 Module | 698 | 1/20/200 |
| 5749 11 | 20A - Switch - SP - 1 Way - Right - 1 Module | 698 | 1/20/200 |
| 5749 12 | 20A - Switch - SP - 1 Way - Middle - 1 Module | 698 | 1/20/200 |
| 5749 13 | 20A - Switch - SP - 1 Way - 2 Module | 830 | 1/10/200 |
| 5749 14 | 20A - Switch - SP - 1 Way - with Indicator - Left - 1 Module | 732 | 1/20/200 |
| 5749 15 | 20A - Switch - SP - 1 Way - with Indicator - Right - 1 Module | 732 | 1/20/200 |
| 5749 16 | 20A - Switch - SP - 2 Way - Middle - 1 Module | 742 | 1/20/200 |
| 5749 17 | 20A - Switch - SP - 2 Way - with Indicator - Left - 1 Module | 1016 | 1/20/200 |
| 5749 18 | 20A - Switch - SP - 2 Way - with Indicator - Right - 1 Module | 1016 | 1/20/200 |
| 5749 19 | 20A - Switch - SP - 2 Way - with Indicator - 2 Module | 962 | 1/10/100 |
| 5749 20 | 20A - Switch - 3 Gang - 1 Way - 2 Module | 2014 | 1/10/100 |
| 5749 21 | 20A - Switch - 3 Gang - 2*2 Way + 1*1 Way - 2 Module | 2124 | 1/10/100 |
| 5749 22 | 20A - Switch - DP - 1 Way - with Indicator - 2 Module | 1572 | 1/10/100 |



5749 16



5749 17



5749 18



5749 22

Push Button - 6A - 230V AC

| | | | |
|---------|---|------|----------|
| 5749 23 | 6A - Bell Push - SP - 1 Way - Right - 1 Module | 574 | 1/20/200 |
| 5749 24 | 6A - Bell Push - SP - 1 Way - Left - 1 Module | 574 | 1/20/200 |
| 5749 25 | 6A - Bell Push - SP - 1 Way - 2 Module | 816 | 1/10/100 |
| 5749 26 | 6A - Bell Push - SP - 1 Way - with Indicator - 2 Module | 1072 | 1/10/100 |



5749 26

Dimmers & Fan Regulators

| | | | |
|---------|--|------|----------|
| 5749 27 | Light Dimmer - 60 to 400 Watts - 2 Module | 2476 | 10/100 |
| 5749 29 | Fan Step Regulator - 100 Watts - ISI - 2 Module | 2410 | 1/10/100 |
| 5749 30 | Fan Step Regulator - 120 Watts - ISI - 2 Module | 2598 | 1/10/100 |
| 5749 31 | Fan Step Regulator - for Energy Saving Fans - 2 Module | 2570 | 1/10/100 |



5749 27



5749 29

* MRP - Maximum Retail Price Inclusive of all taxes including GST.

Bold Cat.Nos are products normally available with Legrand (India) Stockists. **Cat.Nos** that are not bold - delivery within 4 - 8 weeks from the date of order. **Bold packing quantity** is our mandatory packing. Orders to be placed by Legrand (India) Stockist in multiples of the same.

Arteor™

Square Cover Plates with Metal Frame

| Cat.Nos | Description | MRP* ₹ / Unit | Pack |
|--------------------------------|---|------------------|----------|
| Indian Standard Sockets | | | |
| 5749 94 | 6A - Socket - with Shutter - 3 Pin - ISI - 2 Module | 864 | 1/20/200 |

Blanking Plate

| | | | |
|---------|---------------------------|-----|--------|
| 5749 64 | Blanking Plate - 2 Module | 146 | 10/100 |
|---------|---------------------------|-----|--------|

Square Cover Plates with Metal Frame White Cover Plates with Metal Frame

| | | | |
|---------|--|------|--------|
| 5757 00 | Cover Plate - 1 Module - White | 326 | 10/100 |
| 5757 10 | Cover Plate - 2 Module - White | 344 | 10/100 |
| 5757 20 | Cover Plate - 3 Module - White | 386 | 10/100 |
| 5757 30 | Cover Plate - 4 Module - White | 404 | 5/50 |
| 5757 40 | Cover Plate - 6 Module - White | 738 | 5/30 |
| 5757 50 | Cover Plate - 8 Module - White | 820 | 5/30 |
| 5757 60 | Cover Plate - 2*4 Module - White | 1034 | 2/20 |
| 5757 70 | Cover Plate - 2*6 Module - White | 1264 | 2/16 |
| 5757 80 | Cover Plate - 2*8 Module - White | 1514 | 2/16 |
| 5757 90 | Cover Plate - 3*6 Module - White | 1676 | 2/12 |
| 5758 00 | Cover Plate - 3*8 Module - White | 2002 | 2/12 |
| 5750 70 | Cover Plate - for Shaver Socket-3 Module - White | 574 | 5/50 |

Pearl Aluminium Cover Plates with Metal Frame

| | | | |
|---------|--|------|----------|
| 5759 73 | Cover Plate - 1 Module - Pearl Aluminium | 488 | 10/100 |
| 5759 74 | Cover Plate - 2 Module - Pearl Aluminium | 506 | 1/10/100 |
| 5759 75 | Cover Plate - 3 Module - Pearl Aluminium | 548 | 10/100 |
| 5759 76 | Cover Plate - 4 Module - Pearl Aluminium | 620 | 5/50 |
| 5759 77 | Cover Plate - 6 Module - Pearl Aluminium | 1068 | 5/30 |
| 5759 78 | Cover Plate - 8 Module - Pearl Aluminium | 1170 | 1/5/30 |
| 5759 79 | Cover Plate - 2*4 Module - Pearl Aluminium | 1492 | 2/20 |
| 5759 80 | Cover Plate - 2*6 Module - Pearl Aluminium | 1934 | 1/2/16 |
| 5759 81 | Cover Plate - 2*8 Module - Pearl Aluminium | 2188 | 2/16 |
| 5759 82 | Cover Plate - 3*6 Module - Pearl Aluminium | 2560 | 2/12 |
| 5759 83 | Cover Plate - 3*8 Module - Pearl Aluminium | 2914 | 2/12 |

Graphite Cover Plates with Metal Frame

| | | | |
|---------|-----------------------------------|------|----------|
| 5759 61 | Cover Plate - 1 Module - Graphite | 488 | 10/100 |
| 5759 62 | Cover Plate - 2 Module - Graphite | 506 | 1/10/100 |
| 5759 63 | Cover Plate - 3 Module - Graphite | 548 | 10/100 |
| 5759 64 | Cover Plate - 4 Module - Graphite | 620 | 5/50 |
| 5759 66 | Cover Plate - 6 Module - Graphite | 1068 | 5/30 |

* MRP - Maximum Retail Price Inclusive of all taxes including GST.

Arteor™

Square Cover Plates with Metal Frame

| Cat.Nos | Description | MRP* ₹ / Unit | Pack |
|---------|-------------|------------------|------|
|---------|-------------|------------------|------|

Graphite Cover Plates with Metal Frame

| | | | |
|---------|-------------------------------------|------|--------|
| 5759 67 | Cover Plate - 8 Module - Graphite | 1170 | 1/5/30 |
| 5759 68 | Cover Plate - 2*4 Module - Graphite | 1492 | 2/20 |
| 5759 69 | Cover Plate - 2*6 Module - Graphite | 1934 | 1/2/16 |
| 5759 70 | Cover Plate - 2*8 Module - Graphite | 2188 | 2/16 |
| 5759 71 | Cover Plate - 3*6 Module - Graphite | 2560 | 2/12 |
| 5759 72 | Cover Plate - 3*8 Module - Graphite | 2914 | 2/12 |

Magnesium Cover Plates with Metal Frame

| | | | |
|---------|--------------------------------------|------|----------|
| 5755 89 | Cover Plate - 1 Module - Magnesium | 488 | 10/100 |
| 5755 90 | Cover Plate - 2 Module - Magnesium | 506 | 1/10/100 |
| 5755 91 | Cover Plate - 3 Module - Magnesium | 548 | 10/100 |
| 5755 93 | Cover Plate - 4 Module - Magnesium | 620 | 5/50 |
| 5755 94 | Cover Plate - 6 Module - Magnesium | 1068 | 1/5/30 |
| 5755 95 | Cover Plate - 8 Module - Magnesium | 1170 | 1/5/30 |
| 5755 96 | Cover Plate - 2*4 Module - Magnesium | 1492 | 1/2/20 |
| 5755 97 | Cover Plate - 2*6 Module - Magnesium | 1934 | 1/2/16 |
| 5755 98 | Cover Plate - 2*8 Module - Magnesium | 2188 | 2/16 |
| 5755 99 | Cover Plate - 3*6 Module - Magnesium | 2560 | 2/12 |

Champagne Cover Plates with Metal Frame

| | | | |
|---------|--------------------------------------|------|----------|
| 5759 84 | Cover Plate - 1 Module - Champagne | 488 | 10/100 |
| 5759 85 | Cover Plate - 2 Module - Champagne | 506 | 1/10/100 |
| 5759 86 | Cover Plate - 3 Module - Champagne | 548 | 10/100 |
| 5759 87 | Cover Plate - 4 Module - Champagne | 620 | 5/50 |
| 5759 88 | Cover Plate - 6 Module - Champagne | 1068 | 5/30 |
| 5759 89 | Cover Plate - 8 Module - Champagne | 1170 | 1/5/30 |
| 5759 90 | Cover Plate - 2*4 Module - Champagne | 1492 | 2/20 |
| 5759 91 | Cover Plate - 2*6 Module - Champagne | 1934 | 1/2/16 |
| 5759 92 | Cover Plate - 2*8 Module - Champagne | 2188 | 2/16 |
| 5759 93 | Cover Plate - 3*6 Module - Champagne | 2560 | 2/12 |

Dark Bronze Cover Plates with Metal Frame

| | | | |
|---------|--------------------------------------|-----|----------|
| 5756 79 | Cover Plate - 1 Module - Dark Bronze | 488 | 10/100 |
| 5756 80 | Cover Plate - 2 Module - Dark Bronze | 506 | 1/10/100 |
| 5756 81 | Cover Plate - 3 Module - Dark Bronze | 548 | 10/100 |

Bold Cat.Nos are products normally available with Legrand (India) Stockists. **Cat.Nos** that are not bold - delivery within 4 - 8 weeks from the date of order. **Bold packing quantity** is our mandatory packing. Orders to be placed by Legrand (India) Stockist in multiples of the same.

Square Cover Plates with Metal Frame

| Cat.Nos | Description | MRP* ₹ / Unit | Pack |
|---------|-------------|------------------|------|
|---------|-------------|------------------|------|

Dark Bronze Cover Plates with Metal Frame

| | | | |
|---------|--|------|--------|
| 5756 83 | Cover Plate - 4 Module - Dark Bronze | 620 | 5/50 |
| 5756 84 | Cover Plate - 6 Module - Dark Bronze | 1068 | 5/30 |
| 5756 85 | Cover Plate - 8 Module - Dark Bronze | 1170 | 1/5/30 |
| 5756 86 | Cover Plate - 2*4 Module - Dark Bronze | 1492 | 2/20 |
| 5756 87 | Cover Plate - 2*6 Module - Dark Bronze | 1934 | 1/2/16 |
| 5756 88 | Cover Plate - 2*8 Module - Dark Bronze | 2188 | 2/16 |
| 5756 89 | Cover Plate - 3*6 Module - Dark Bronze | 2560 | 2/12 |

Pearl Aluminium Cover Plates with Overmoulded Frame

| | | | |
|---------|--|------|--------|
| 5757 01 | Cover Plate - 1 Module - Pearl Aluminium | 540 | 10/100 |
| 5757 11 | Cover Plate - 2 Module - Pearl Aluminium | 572 | 10/100 |
| 5757 21 | Cover Plate - 3 Module - Pearl Aluminium | 608 | 10/100 |
| 5757 31 | Cover Plate - 4 Module - Pearl Aluminium | 690 | 5/50 |
| 5757 41 | Cover Plate - 6 Module - Pearl Aluminium | 1172 | 5/30 |
| 5757 51 | Cover Plate - 8 Module - Pearl Aluminium | 1302 | 5/30 |
| 5757 61 | Cover Plate - 2*4 Module - Pearl Aluminium | 1652 | 2/20 |
| 5757 71 | Cover Plate - 2*6 Module - Pearl Aluminium | 2146 | 2/16 |
| 5757 81 | Cover Plate - 2*8 Module - Pearl Aluminium | 2438 | 2/16 |
| 5757 91 | Cover Plate - 3*6 Module - Pearl Aluminium | 2852 | 2/12 |
| 5758 01 | Cover Plate - 3*8 Module - Pearl Aluminium | 3236 | 2/12 |
| 5750 71 | Cover Plate - for Shaver Socket-3 Module - Pearl Aluminium | 920 | 5/50 |

Graphite Cover Plates with Overmoulded Frame

| | | | |
|---------|-------------------------------------|------|--------|
| 5757 02 | Cover Plate - 1 Module - Graphite | 540 | 10/100 |
| 5757 12 | Cover Plate - 2 Module - Graphite | 572 | 10/100 |
| 5757 22 | Cover Plate - 3 Module - Graphite | 608 | 10/100 |
| 5757 32 | Cover Plate - 4 Module - Graphite | 690 | 5/50 |
| 5757 42 | Cover Plate - 6 Module - Graphite | 1172 | 5/30 |
| 5757 52 | Cover Plate - 8 Module - Graphite | 1302 | 5/30 |
| 5757 62 | Cover Plate - 2*4 Module - Graphite | 1652 | 2/20 |
| 5757 72 | Cover Plate - 2*6 Module - Graphite | 2146 | 2/16 |

Square Cover Plates

| Cat.Nos | Description | MRP* ₹ / Unit | Pack |
|---------|-------------|------------------|------|
|---------|-------------|------------------|------|

Graphite Cover Plates with Overmoulded Frame

| | | | |
|---------|---|------|------|
| 5757 82 | Cover Plate - 2*8 Module - Graphite | 2438 | 2/16 |
| 5757 92 | Cover Plate - 3*6 Module - Graphite | 2852 | 2/12 |
| 5758 02 | Cover Plate - 3*8 Module - Graphite | 3238 | 2/12 |
| 5750 72 | Cover Plate - for Shaver Socket-3 Module - Graphite | 920 | 5/50 |

Magnesium Cover Plates with Overmoulded Frame

| | | | |
|---------|--|------|--------|
| 5758 11 | Cover Plate - 1 Module - Magnesium | 540 | 10/100 |
| 5758 12 | Cover Plate - 2 Module - Magnesium | 572 | 10/100 |
| 5758 13 | Cover Plate - 3 Module - Magnesium | 608 | 10/100 |
| 5758 14 | Cover Plate - 4 Module - Magnesium | 690 | 1/5/50 |
| 5758 15 | Cover Plate - 6 Module - Magnesium | 1172 | 5/30 |
| 5758 16 | Cover Plate - 8 Module - Magnesium | 1302 | 5/30 |
| 5758 17 | Cover Plate - 2*4 Module - Magnesium | 1652 | 2/20 |
| 5758 18 | Cover Plate - 2*6 Module - Magnesium | 2146 | 2/16 |
| 5758 19 | Cover Plate - 2*8 Module - Magnesium | 2438 | 2/16 |
| 5758 20 | Cover Plate - 3*6 Module - Magnesium | 2852 | 2/12 |
| 5758 21 | Cover Plate - for Shaver Socket-3 Module - Magnesium | 924 | 5/50 |

Champagne Cover Plates with Overmoulded Frame

| | | | |
|---------|--|------|--------|
| 5758 22 | Cover Plate - 1 Module - Champagne | 540 | 10/100 |
| 5758 23 | Cover Plate - 2 Module - Champagne | 572 | 10/100 |
| 5758 24 | Cover Plate - 3 Module - Champagne | 608 | 10/100 |
| 5758 25 | Cover Plate - 4 Module - Champagne | 690 | 5/50 |
| 5758 26 | Cover Plate - 6 Module - Champagne | 1172 | 5/30 |
| 5758 27 | Cover Plate - 8 Module - Champagne | 1302 | 5/30 |
| 5758 28 | Cover Plate - 2*4 Module - Champagne | 1652 | 2/20 |
| 5758 29 | Cover Plate - 2*6 Module - Champagne | 2146 | 2/16 |
| 5758 30 | Cover Plate - 2*8 Module - Champagne | 2438 | 2/16 |
| 5758 31 | Cover Plate - 3*6 Module - Champagne | 2852 | 2/12 |
| 5758 32 | Cover Plate - for Shaver Socket-3 Module - Champagne | 924 | 5/50 |



5757 21



5757 61



5758 13



5758 17



5758 24



5758 28



5757 22



5757 42

* MRP - Maximum Retail Price Inclusive of all taxes including GST.

Bold Cat.Nos are products normally available with Legrand (India) Stockists. **Cat.Nos that are not bold** - delivery within 4 - 8 weeks from the date of order. **Bold packing quantity** is our mandatory packing. Orders to be placed by Legrand (India) Stockist in multiples of the same.

Arteor™

Square Cover Plates

| Cat.Nos | Description | MRP* ₹ / Unit | Pack |
|--|--|------------------|--------|
| Dark Bronze Cover Plates with Overmoulded Frame | | | |
| 5758 33 | Cover Plate - 1 Module - Dark Bronze | 540 | 10/100 |
| 5758 34 | Cover Plate - 2 Module - Dark Bronze | 572 | 10/100 |
| 5758 35 | Cover Plate - 3 Module - Dark Bronze | 608 | 10/100 |
| 5758 36 | Cover Plate - 4 Module - Dark Bronze | 690 | 5/50 |
| 5758 37 | Cover Plate - 6 Module - Dark Bronze | 1172 | 5/30 |
| 5758 38 | Cover Plate - 8 Module - Dark Bronze | 1302 | 5/30 |
| 5758 39 | Cover Plate - 2*4 Module - Dark Bronze | 1652 | 2/20 |
| 5758 40 | Cover Plate - 2*6 Module - Dark Bronze | 2146 | 2/16 |
| 5758 41 | Cover Plate - 2*8 Module - Dark Bronze | 2438 | 2/16 |
| 5758 42 | Cover Plate - 3*6 Module - Dark Bronze | 2852 | 2/12 |
| 5758 43 | Cover Plate - for Shaver Socket-3 Module - Dark Bronze | 924 | 5/50 |

Mirror Finish Cover Plates with Overmoulded Frame Mirror Black Cover Plates with Overmoulded Frame

| | | | |
|---------|---|-------|--------|
| 5757 03 | Cover Plate - 1 Module - Mirror Black | 2756 | 1/5/30 |
| 5757 13 | Cover Plate - 2 Module - Mirror Black | 2948 | 1/5/30 |
| 5757 23 | Cover Plate - 3 Module - Mirror Black | 3158 | 1/20 |
| 5757 33 | Cover Plate - 4 Module - Mirror Black | 3354 | 1/20 |
| 5757 43 | Cover Plate - 6 Module - Mirror Black | 6106 | 1/5 |
| 5757 53 | Cover Plate - 8 Module - Mirror Black | 6726 | 1/5 |
| 5757 63 | Cover Plate - 2*4 Module - Mirror Black | 8524 | 1/10 |
| 5757 73 | Cover Plate - 2*6 Module - Mirror Black | 10486 | 1/8 |

Mirror White Cover Plates with Overmoulded Frame

| | | | |
|---------|---|-------|--------|
| 5757 04 | Cover Plate - 1 Module - Mirror White | 2756 | 1/5/30 |
| 5757 14 | Cover Plate - 2 Module - Mirror White | 2948 | 1/5/30 |
| 5757 24 | Cover Plate - 3 Module - Mirror White | 3158 | 1/20 |
| 5757 34 | Cover Plate - 4 Module - Mirror White | 3354 | 1/20 |
| 5757 44 | Cover Plate - 6 Module - Mirror White | 6106 | 1/5 |
| 5757 54 | Cover Plate - 8 Module - Mirror White | 6726 | 1/5 |
| 5757 64 | Cover Plate - 2*4 Module - Mirror White | 8680 | 1/10 |
| 5757 74 | Cover Plate - 2*6 Module - Mirror White | 10486 | 1/8 |

Arteor™

Square Cover Plates

| Cat.Nos | Description | MRP* ₹ / Unit | Pack |
|---|--|------------------|--------|
| Mirror Green Apple Cover Plates with Overmoulded Frame | | | |
| 5758 44 | Cover Plate - 1 Module - Green Apple | 2756 | 1/5/30 |
| 5758 45 | Cover Plate - 2 Module - Green Apple | 2948 | 1/5/30 |
| 5758 46 | Cover Plate - 3 Module - Green Apple | 3158 | 1/20 |
| 5758 47 | Cover Plate - 4 Module - Green Apple | 3354 | 1/20 |
| 5758 48 | Cover Plate - 6 Module - Green Apple | 6106 | 1/5 |
| 5758 49 | Cover Plate - 8 Module - Green Apple | 6726 | 1/5 |
| 5758 50 | Cover Plate - 2*4 Module - Green Apple | 8678 | 1/10 |
| 5758 51 | Cover Plate - 2*6 Module - Green Apple | 10486 | 1/8 |
| 5758 52 | Cover Plate - for Shaver Socket-3 Module - Green Apple | 4598 | 1/5/50 |

Graphic Casual Cover Plates with Overmoulded Frame

| | | | |
|---------|---|-------|--------|
| 5762 91 | Cover Plate - 1 Module - Graphic Casual | 3346 | 1/5/30 |
| 5763 11 | Cover Plate - 2 Module - Graphic Casual | 3600 | 1/5/30 |
| 5763 31 | Cover Plate - 3 Module - Graphic Casual | 3868 | 1/20 |
| 5763 51 | Cover Plate - 4 Module - Graphic Casual | 4128 | 1/20 |
| 5763 81 | Cover Plate - 6 Module - Graphic Casual | 7474 | 1/5 |
| 5764 01 | Cover Plate - 8 Module - Graphic Casual | 8244 | 1/5 |
| 5758 89 | Cover Plate - 2*4 Module - Graphic Casual | 10380 | 1/10 |
| 5758 90 | Cover Plate - 2*6 Module - Graphic Casual | 12850 | 1/8 |

Silver Baroque Cover Plates with Overmoulded Frame

| | | | |
|---------|---|------|--------|
| 5758 53 | Cover Plate - 1 Module - Silver Baroque | 3346 | 1/5/30 |
| 5758 54 | Cover Plate - 2 Module - Silver Baroque | 3600 | 1/5/30 |
| 5758 55 | Cover Plate - 3 Module - Silver Baroque | 3868 | 1/0/20 |
| 5758 56 | Cover Plate - 4 Module - Silver Baroque | 4128 | 1/0/20 |
| 5758 57 | Cover Plate - 6 Module - Silver Baroque | 7474 | 1/0/5 |

* MRP - Maximum Retail Price Inclusive of all taxes including GST.

Bold Cat.Nos are products normally available with Legrand (India) Stockists. **Cat.Nos that are not bold** - delivery within 4 - 8 weeks from the date of order. **Bold packing quantity** is our mandatory packing. Orders to be placed by Legrand (India) Stockist in multiples of the same.

Arteor™

Square Cover Plates

| Cat.Nos | Description | MRP* ₹ / Unit | Pack |
|---------|---|------------------|--------|
| 5758 58 | Cover Plate - 8 Module - Silver Baroque | 8244 | 1/0/5 |
| 5758 59 | Cover Plate - 2*4 Module - Silver Baroque | 10380 | 1/0/10 |
| 5758 60 | Cover Plate - 2*6 Module - Silver Baroque | 12850 | 1/0/8 |
| 5758 61 | Cover Plate - for Shaver Socket-3 Module - Silver Baroque | 5284 | 1/5/50 |

Dark Baroque Cover Plates with Overmoulded Frame

| | | | |
|---------|---|-------|--------|
| 5758 62 | Cover Plate - 1 Module - Dark Baroque | 3346 | 1/5/30 |
| 5758 63 | Cover Plate - 2 Module - Dark Baroque | 3600 | 1/5/30 |
| 5758 64 | Cover Plate - 3 Module - Dark Baroque | 3868 | 1/0/20 |
| 5758 65 | Cover Plate - 4 Module - Dark Baroque | 4128 | 1/0/20 |
| 5758 66 | Cover Plate - 6 Module - Dark Baroque | 7474 | 1/0/5 |
| 5758 67 | Cover Plate - 8 Module - Dark Baroque | 8244 | 1/0/5 |
| 5758 68 | Cover Plate - 2*4 Module - Dark Baroque | 10378 | 1/0/10 |
| 5758 69 | Cover Plate - 2*6 Module - Dark Baroque | 12850 | 1/0/8 |
| 5758 70 | Cover Plate - for Shaver Socket-3 Module - Dark Baroque | 5284 | 1/5/50 |

Metal Finish Cover Plates with Overmoulded Frame

Gold Brass Cover Plates with Overmoulded Frame

| | | | |
|---------|-------------------------------------|-------|--------|
| 5762 90 | Cover Plate - 1 Module - Gold Brass | 4492 | 1/5/30 |
| 5763 10 | Cover Plate - 2 Module - Gold Brass | 4808 | 1/5/30 |
| 5763 30 | Cover Plate - 3 Module - Gold Brass | 5172 | 1/0/20 |
| 5763 50 | Cover Plate - 4 Module - Gold Brass | 5486 | 1/0/20 |
| 5763 80 | Cover Plate - 6 Module - Gold Brass | 9986 | 1/0/5 |
| 5764 00 | Cover Plate - 8 Module - Gold Brass | 10976 | 1/0/5 |

* MRP - Maximum Retail Price Inclusive of all taxes including GST.

Arteor™

Square Cover Plates

| Cat.Nos | Description | MRP* ₹ / Unit | Pack |
|---------|-------------|------------------|------|
|---------|-------------|------------------|------|

Stainless Steel Cover Plates with Overmoulded Frame

| | | | |
|---------|--|-------|--------|
| 5757 06 | Cover Plate - 1 Module - Stainless Steel | 4492 | 1/5/30 |
| 5757 16 | Cover Plate - 2 Module - Stainless Steel | 4808 | 1/5/30 |
| 5757 26 | Cover Plate - 3 Module - Stainless Steel | 5172 | 1/20 |
| 5757 36 | Cover Plate - 4 Module - Stainless Steel | 5486 | 1/20 |
| 5757 46 | Cover Plate - 6 Module - Stainless Steel | 9986 | 1/5 |
| 5757 56 | Cover Plate - 8 Module - Stainless Steel | 10976 | 1/0/5 |
| 5757 66 | Cover Plate - 2*4 Module - Stainless Steel | 13878 | 1/0/10 |
| 5757 76 | Cover Plate - 2*6 Module - Stainless Steel | 17104 | 1/8 |

Wood Cover Plates with Overmoulded Frame

| | | | |
|---------|---|-------|--------|
| 5758 80 | Cover Plate - 1 Module - Grey Oak | 2632 | 1/5/30 |
| 5758 81 | Cover Plate - 2 Module - Grey Oak | 2792 | 1/5/30 |
| 5758 82 | Cover Plate - 3 Module - Grey Oak | 3446 | 1/20 |
| 5758 83 | Cover Plate - 4 Module - Grey Oak | 3820 | 1/20 |
| 5758 84 | Cover Plate - 6 Module - Grey Oak | 5672 | 1/5 |
| 5758 85 | Cover Plate - 8 Module - Grey Oak | 6822 | 1/5 |
| 5758 86 | Cover Plate - 2*4 Module - Grey Oak | 8102 | 1/10 |
| 5758 87 | Cover Plate - 2*6 Module - Grey Oak | 10856 | 1/8 |
| 5758 88 | Cover Plate - for Shaver Socket-3 Module - Grey Oak | 3364 | 1/5/50 |

Signature Cover Plates with Overmoulded Frame

| | | | |
|---------|---|-------|--------|
| 5758 71 | Cover Plate - 1 Module - Cube Plate | 8610 | 1/5/30 |
| 5758 72 | Cover Plate - 2 Module - Cube Plate | 8764 | 1/5/30 |
| 5758 73 | Cover Plate - 3 Module - Cube Plate | 10024 | 1/20 |
| 5758 74 | Cover Plate - 4 Module - Cube Plate | 10358 | 1/20 |
| 5758 75 | Cover Plate - 6 Module - Cube Plate | 13492 | 1/5 |
| 5758 76 | Cover Plate - 8 Module - Cube Plate | 14158 | 1/5 |
| 5758 77 | Cover Plate - 2*4 Module - Cube Plate | 21154 | 1/10 |
| 5758 78 | Cover Plate - 2*6 Module - Cube Plate | 23434 | 1/8 |
| 5758 79 | Cover Plate - for Shaver Socket-3 Module - Cube Plate | 9610 | 1/5/50 |

Bold Cat.Nos are products normally available with Legrand (India) Stockists. **Cat.Nos** that are not bold - delivery within 4 - 8 weeks from the date of order. **Bold packing quantity** is our mandatory packing. Orders to be placed by Legrand (India) Stockist in multiples of the same.

Arteor™

Round Cover Plates

| Cat.Nos | Description | MRP* ₹ / Unit | Pack |
|---------|-------------|------------------|------|
|---------|-------------|------------------|------|

Round Cover Plates with Metal Frame

Round - White Cover Plates with Metal Frame

| | | | |
|---------|----------------------------------|------|--------|
| 5759 00 | Cover Plate - 2 Module - White | 498 | 10/100 |
| 5759 10 | Cover Plate - 3 Module - White | 526 | 10/100 |
| 5759 20 | Cover Plate - 4 Module - White | 554 | 5/50 |
| 5759 30 | Cover Plate - 6 Module - White | 1012 | 5/30 |
| 5765 80 | Cover Plate - 8 Module - White | 1118 | 5/30 |
| 5759 40 | Cover Plate - 2*4 Module - White | 1180 | 2/20 |
| 5759 50 | Cover Plate - 2*6 Module - White | 1720 | 2/16 |

Round - Pearl Aluminium Cover Plates with Metal Frame

| | | | |
|---------|--|------|--------|
| 5757 93 | Cover Plate - 2 Module - Pearl Aluminium | 668 | 10/100 |
| 5757 94 | Cover Plate - 3 Module - Pearl Aluminium | 722 | 10/100 |
| 5757 95 | Cover Plate - 4 Module - Pearl Aluminium | 812 | 5/50 |
| 5757 96 | Cover Plate - 6 Module - Pearl Aluminium | 1382 | 5/30 |
| 5757 97 | Cover Plate - 8 Module - Pearl Aluminium | 1532 | 5/30 |
| 5757 98 | Cover Plate - 2*4 Module - Pearl Aluminium | 1932 | 2/20 |
| 5757 99 | Cover Plate - 2*6 Module - Pearl Aluminium | 2518 | 2/16 |

Round - Graphite Cover Plates with Metal Frame

| | | | |
|---------|-------------------------------------|------|--------|
| 5758 03 | Cover Plate - 2 Module - Graphite | 668 | 10/100 |
| 5758 04 | Cover Plate - 3 Module - Graphite | 722 | 10/100 |
| 5758 05 | Cover Plate - 4 Module - Graphite | 812 | 5/50 |
| 5758 06 | Cover Plate - 6 Module - Graphite | 1376 | 5/30 |
| 5758 07 | Cover Plate - 8 Module - Graphite | 1532 | 5/30 |
| 5758 08 | Cover Plate - 2*4 Module - Graphite | 1932 | 2/20 |
| 5758 09 | Cover Plate - 2*6 Module - Graphite | 2518 | 2/16 |

Round - Magnesium Cover Plates with Metal Frame

| | | | |
|---------|--------------------------------------|------|--------|
| 5756 23 | Cover Plate - 2 Module - Magnesium | 668 | 10/100 |
| 5756 24 | Cover Plate - 3 Module - Magnesium | 722 | 10/100 |
| 5756 25 | Cover Plate - 4 Module - Magnesium | 812 | 5/50 |
| 5756 26 | Cover Plate - 6 Module - Magnesium | 1376 | 5/30 |
| 5756 27 | Cover Plate - 8 Module - Magnesium | 1528 | 5/30 |
| 5756 28 | Cover Plate - 2*4 Module - Magnesium | 1932 | 2/20 |
| 5756 29 | Cover Plate - 2*6 Module - Magnesium | 2518 | 2/16 |



5759 00



5759 10



5759 30



5759 80



5759 50



5759 41



5759 22

Arteor™

Round Cover Plates

| Cat.Nos | Description | MRP* ₹ / Unit | Pack |
|---------|-------------|------------------|------|
|---------|-------------|------------------|------|

Round - Champagne Cover Plates with Metal Frame

| | | | |
|---------|--------------------------------------|------|--------|
| 5758 91 | Cover Plate - 2 Module - Champagne | 668 | 10/100 |
| 5758 92 | Cover Plate - 3 Module - Champagne | 722 | 10/100 |
| 5758 93 | Cover Plate - 4 Module - Champagne | 812 | 5/50 |
| 5758 94 | Cover Plate - 6 Module - Champagne | 1376 | 5/30 |
| 5758 95 | Cover Plate - 8 Module - Champagne | 1532 | 5/30 |
| 5758 96 | Cover Plate - 2*4 Module - Champagne | 1934 | 2/20 |
| 5758 97 | Cover Plate - 2*6 Module - Champagne | 2518 | 2/16 |

Round - Dark Bronze Cover Plates with Metal Frame

| | | | |
|---------|--|------|--------|
| 5756 93 | Cover Plate - 2 Module - Dark Bronze | 668 | 10/100 |
| 5756 94 | Cover Plate - 3 Module - Dark Bronze | 722 | 10/100 |
| 5756 95 | Cover Plate - 4 Module - Dark Bronze | 810 | 5/50 |
| 5756 96 | Cover Plate - 6 Module - Dark Bronze | 1376 | 5/30 |
| 5756 97 | Cover Plate - 8 Module - Dark Bronze | 1528 | 5/30 |
| 5756 98 | Cover Plate - 2*4 Module - Dark Bronze | 1932 | 2/20 |
| 5756 99 | Cover Plate - 2*6 Module - Dark Bronze | 2518 | 2/16 |

Round - Pearl Aluminium Cover Plates with Overmoulded frame

| | | | |
|---------|--|------|--------|
| 5759 01 | Cover Plate - 2 Module - Pearl Aluminium | 754 | 10/100 |
| 5759 11 | Cover Plate - 3 Module - Pearl Aluminium | 796 | 10/100 |
| 5759 21 | Cover Plate - 4 Module - Pearl Aluminium | 842 | 5/50 |
| 5759 31 | Cover Plate - 6 Module - Pearl Aluminium | 1532 | 5/30 |
| 5765 81 | Cover Plate - 8 Module - Pearl Aluminium | 1684 | 5/30 |
| 5759 41 | Cover Plate - 2*4 Module - Pearl Aluminium | 1768 | 2/20 |
| 5759 51 | Cover Plate - 2*6 Module - Pearl Aluminium | 2616 | 2/16 |

Round - Graphite Cover Plates with Overmoulded Frame

| | | | |
|---------|-------------------------------------|------|--------|
| 5759 02 | Cover Plate - 2 Module - Graphite | 754 | 10/100 |
| 5759 12 | Cover Plate - 3 Module - Graphite | 796 | 10/100 |
| 5759 22 | Cover Plate - 4 Module - Graphite | 842 | 5/50 |
| 5759 32 | Cover Plate - 6 Module - Graphite | 1532 | 5/30 |
| 5765 82 | Cover Plate - 8 Module - Graphite | 1684 | 5/30 |
| 5759 42 | Cover Plate - 2*4 Module - Graphite | 1768 | 2/20 |

* MRP - Maximum Retail Price Inclusive of all taxes including GST.

Bold Cat.Nos are products normally available with Legrand (India) Stockists. **Cat.Nos that are not bold** - delivery within 4 - 8 weeks from the date of order. **Bold packing quantity** is our mandatory packing. Orders to be placed by Legrand (India) Stockist in multiples of the same.

Arteor™

Round Cover Plates

| Cat.Nos | Description | MRP* ₹ / Unit | Pack |
|---------|-------------|------------------|------|
|---------|-------------|------------------|------|

Round - Graphite Cover Plates with Overmoulded Frame

| | | | |
|---------|-------------------------------------|------|------|
| 5759 52 | Cover Plate - 2*6 Module - Graphite | 2616 | 2/16 |
|---------|-------------------------------------|------|------|

Round - Magnesium Cover Plates with Overmoulded Frame

| | | | |
|---------|--------------------------------------|------|--------|
| 5768 41 | Cover Plate - 2 Module - Magnesium | 754 | 10/100 |
| 5768 42 | Cover Plate - 3 Module - Magnesium | 796 | 10/100 |
| 5768 43 | Cover Plate - 4 Module - Magnesium | 842 | 5/50 |
| 5768 44 | Cover Plate - 6 Module - Magnesium | 1532 | 5/30 |
| 5768 45 | Cover Plate - 8 Module - Magnesium | 1684 | 5/30 |
| 5768 46 | Cover Plate - 2*4 Module - Magnesium | 1768 | 2/20 |
| 5768 47 | Cover Plate - 2*6 Module - Magnesium | 2616 | 2/16 |

Round - Champagne Cover Plates with Overmoulded Frame

| | | | |
|---------|--------------------------------------|------|--------|
| 5768 48 | Cover Plate - 2 Module - Champagne | 754 | 10/100 |
| 5768 49 | Cover Plate - 3 Module - Champagne | 796 | 10/100 |
| 5768 50 | Cover Plate - 4 Module - Champagne | 842 | 5/50 |
| 5768 51 | Cover Plate - 6 Module - Champagne | 1532 | 5/30 |
| 5768 52 | Cover Plate - 8 Module - Champagne | 1684 | 5/30 |
| 5768 53 | Cover Plate - 2*4 Module - Champagne | 1768 | 2/20 |
| 5768 54 | Cover Plate - 2*6 Module - Champagne | 2616 | 2/16 |

Round - Dark Bronze Cover Plates with Overmoulded Frame

| | | | |
|---------|--|------|--------|
| 5768 55 | Cover Plate - 2 Module - Dark Bronze | 754 | 10/100 |
| 5768 56 | Cover Plate - 3 Module - Dark Bronze | 796 | 10/100 |
| 5768 57 | Cover Plate - 4 Module - Dark Bronze | 842 | 5/50 |
| 5768 58 | Cover Plate - 6 Module - Dark Bronze | 1532 | 5/30 |
| 5768 59 | Cover Plate - 8 Module - Dark Bronze | 1684 | 5/30 |
| 5768 60 | Cover Plate - 2*4 Module - Dark Bronze | 1768 | 2/20 |
| 5768 61 | Cover Plate - 2*6 Module - Dark Bronze | 2616 | 2/16 |

Round Mirror Finish Cover Plates

Round - Mirror Black Cover Plates with Overmoulded Frame

| | | | |
|---------|---------------------------------------|------|--------|
| 5759 03 | Cover Plate - 2 Module - Mirror Black | 3250 | 1/5/30 |
| 5759 13 | Cover Plate - 3 Module - Mirror Black | 3486 | 1/20 |

* MRP - Maximum Retail Price Inclusive of all taxes including GST.

Arteor™

Round Cover Plates

| Cat.Nos | Description | MRP* ₹ / Unit | Pack |
|---------|-------------|------------------|------|
|---------|-------------|------------------|------|

Round Mirror Finish Cover Plates

Round - Mirror Black Cover Plates with Overmoulded Frame

| | | | |
|---------|---|-------|------|
| 5759 23 | Cover Plate - 4 Module - Mirror Black | 3708 | 1/20 |
| 5759 33 | Cover Plate - 6 Module - Mirror Black | 6708 | 1/5 |
| 5765 83 | Cover Plate - 8 Module - Mirror Black | 7408 | 1/5 |
| 5759 43 | Cover Plate - 2*4 Module - Mirror Black | 8732 | 1/10 |
| 5759 53 | Cover Plate - 2*6 Module - Mirror Black | 11544 | 1/8 |

Round - Mirror White Cover Plates with Overmoulded Frame

| | | | |
|---------|---|-------|--------|
| 5759 04 | Cover Plate - 2 Module - Mirror White | 3250 | 1/5/30 |
| 5759 14 | Cover Plate - 3 Module - Mirror White | 3486 | 1/20 |
| 5759 24 | Cover Plate - 4 Module - Mirror White | 3708 | 1/20 |
| 5759 34 | Cover Plate - 6 Module - Mirror White | 6708 | 1/5 |
| 5765 84 | Cover Plate - 8 Module - Mirror White | 7408 | 1/5 |
| 5759 44 | Cover Plate - 2*4 Module - Mirror White | 8914 | 1/10 |
| 5759 54 | Cover Plate - 2*6 Module - Mirror White | 11544 | 1/8 |

Round - Green Apple Cover Plates with Overmoulded Frame

| | | | |
|---------|--|-------|--------|
| 5768 62 | Cover Plate - 2 Module - Green Apple | 3250 | 1/5/30 |
| 5768 63 | Cover Plate - 3 Module - Green Apple | 3486 | 1/20 |
| 5768 64 | Cover Plate - 4 Module - Green Apple | 3708 | 1/20 |
| 5768 65 | Cover Plate - 6 Module - Green Apple | 6706 | 1/5 |
| 5768 66 | Cover Plate - 8 Module - Green Apple | 7408 | 1/5 |
| 5768 67 | Cover Plate - 2*4 Module - Green Apple | 8910 | 1/10 |
| 5768 68 | Cover Plate - 2*6 Module - Green Apple | 11544 | 1/8 |

Round - Graphic Casual Cover Plates with Overmoulded Frame

| | | | |
|---------|---|------|--------|
| 5763 01 | Cover Plate - 2 Module - Graphic Casual | 3972 | 1/5/30 |
|---------|---|------|--------|

Bold Cat.Nos are products normally available with Legrand (India) Stockists. **Cat.Nos** that are not bold - delivery within 4 - 8 weeks from the date of order. **Bold packing quantity** is our mandatory packing. Orders to be placed by Legrand (India) Stockist in multiples of the same.

Arteor™

Round Cover Plates

| Cat.Nos | Description | MRP* ₹ / Unit | Pack |
|---------|-------------|------------------|------|
|---------|-------------|------------------|------|

Round - Graphic Casual Cover Plates with Overmoulded Frame

| | | | |
|---------|---|-------|------|
| 5763 21 | Cover Plate - 3 Module - Graphic Casual | 4252 | 1/20 |
| 5763 41 | Cover Plate - 4 Module - Graphic Casual | 4538 | 1/20 |
| 5763 61 | Cover Plate - 6 Module - Graphic Casual | 8224 | 1/5 |
| 5763 91 | Cover Plate - 8 Module - Graphic Casual | 9056 | 1/5 |
| 5768 97 | Cover Plate - 2*4 Module - Graphic Casual | 10864 | 1/10 |
| 5768 98 | Cover Plate - 2*6 Module - Graphic Casual | 14134 | 1/8 |

Round - Silver Baroque Cover Plates with Overmoulded Frame

| | | | |
|---------|---|-------|--------|
| 5768 69 | Cover Plate - 2 Module - Silver Baroque | 3972 | 1/5/30 |
| 5768 70 | Cover Plate - 3 Module - Silver Baroque | 4252 | 1/20 |
| 5768 71 | Cover Plate - 4 Module - Silver Baroque | 4538 | 1/20 |
| 5768 72 | Cover Plate - 6 Module - Silver Baroque | 8224 | 1/5 |
| 5768 73 | Cover Plate - 8 Module - Silver Baroque | 9056 | 1/5 |
| 5768 74 | Cover Plate - 2*4 Module - Silver Baroque | 10864 | 1/10 |
| 5768 75 | Cover Plate - 2*6 Module - Silver Baroque | 14134 | 1/8 |

Round - Dark Baroque Cover Plates with Overmoulded Frame

| | | | |
|---------|---|-------|--------|
| 5768 76 | Cover Plate - 2 Module - Dark Baroque | 3972 | 1/5/30 |
| 5768 77 | Cover Plate - 3 Module - Dark Baroque | 4252 | 1/20 |
| 5768 78 | Cover Plate - 4 Module - Dark Baroque | 4538 | 1/20 |
| 5768 79 | Cover Plate - 6 Module - Dark Baroque | 8224 | 1/5 |
| 5768 80 | Cover Plate - 8 Module - Dark Baroque | 9056 | 1/5 |
| 5768 81 | Cover Plate - 2*4 Module - Dark Baroque | 10864 | 1/10 |
| 5768 82 | Cover Plate - 2*6 Module - Dark Baroque | 14134 | 1/8 |

Arteor™

Round Cover Plates

| Cat.Nos | Description | MRP* ₹ / Unit | Pack |
|---------|-------------|------------------|------|
|---------|-------------|------------------|------|

Round - Gold Brass Cover Plates with Overmoulded Frame

| | | | |
|---------|-------------------------------------|-------|--------|
| 5763 00 | Cover Plate - 2 Module - Gold Brass | 5300 | 1/5/30 |
| 5763 20 | Cover Plate - 3 Module - Gold Brass | 5660 | 1/20 |
| 5763 40 | Cover Plate - 4 Module - Gold Brass | 6038 | 1/20 |
| 5763 60 | Cover Plate - 6 Module - Gold Brass | 10970 | 1/5 |
| 5763 90 | Cover Plate - 8 Module - Gold Brass | 12086 | 1/5 |

Round - Stainless Steel Cover Plates with Overmoulded Frame

| | | | |
|---------|--|-------|--------|
| 5759 06 | Cover Plate - 2 Module - Stainless Steel | 5300 | 1/5/30 |
| 5759 16 | Cover Plate - 3 Module - Stainless Steel | 5660 | 1/20 |
| 5759 26 | Cover Plate - 4 Module - Stainless Steel | 6038 | 1/20 |
| 5759 36 | Cover Plate - 6 Module - Stainless Steel | 10970 | 1/5 |
| 5765 86 | Cover Plate - 8 Module - Stainless Steel | 12086 | 1/5 |
| 5759 46 | Cover Plate - 2*4 Module - Stainless Steel | 15280 | 1/10 |
| 5759 56 | Cover Plate - 2*6 Module - Stainless Steel | 18808 | 1/8 |

Round - Wood Cover Plates with Overmoulded Frame

| | | | |
|---------|-------------------------------------|-------|--------|
| 5768 90 | Cover Plate - 2 Module - Grey Oak | 2790 | 1/5/30 |
| 5768 91 | Cover Plate - 3 Module - Grey Oak | 4126 | 1/20 |
| 5768 92 | Cover Plate - 4 Module - Grey Oak | 4280 | 1/20 |
| 5768 93 | Cover Plate - 6 Module - Grey Oak | 6076 | 1/5 |
| 5768 94 | Cover Plate - 8 Module - Grey Oak | 7404 | 1/5 |
| 5768 95 | Cover Plate - 2*4 Module - Grey Oak | 7912 | 1/10 |
| 5768 96 | Cover Plate - 2*6 Module - Grey Oak | 10124 | 1/8 |

* MRP - Maximum Retail Price Inclusive of all taxes including GST.

Bold Cat.Nos are products normally available with Legrand (India) Stockists. **Cat.Nos that are not bold** - delivery within 4 - 8 weeks from the date of order. **Bold packing quantity** is our mandatory packing. Orders to be placed by Legrand (India) Stockist in multiples of the same.

Arteor™

Round Cover Plates

| Cat.Nos | Description | MRP* ₹ / Unit | Pack |
|--|---------------------------------------|------------------|--------|
| Round - Signature Cover Plates with Overmoulded Frame | | | |
| 5768 83 | Cover Plate - 2 Module - Cube Plate | 8764 | 1/5/30 |
| 5768 84 | Cover Plate - 3 Module - Cube Plate | 10652 | 1/20 |
| 5768 85 | Cover Plate - 4 Module - Cube Plate | 10848 | 1/20 |
| 5768 86 | Cover Plate - 6 Module - Cube Plate | 13886 | 1/5 |
| 5768 87 | Cover Plate - 8 Module - Cube Plate | 14732 | 1/5 |
| 5768 88 | Cover Plate - 2*4 Module - Cube Plate | 20496 | 1/10 |
| 5768 89 | Cover Plate - 2*6 Module - Cube Plate | 23190 | 1/8 |



5768 84

Accessories

Plastic Surface Boxes

| | | | |
|---------|------------------------------------|-----|----|
| 5734 91 | Plastic Surface Box - 1/2 Module | 144 | 55 |
| 5735 20 | Plastic Surface Box - 3 Module | 172 | 42 |
| 5735 70 | Plastic Surface Box - 4 Module | 204 | 27 |
| 5735 71 | Plastic Surface Box - 6 Module | 254 | 20 |
| 5723 94 | Plastic Surface Box - 8 Module | 286 | 20 |
| 5735 74 | Plastic Surface Box - 2*4 Module | 350 | 10 |
| 5735 72 | Plastic Surface Box - 12/16 Module | 900 | 11 |
| 5735 73 | Plastic Surface Box - 18/24 Module | 952 | 8 |



5735 70

* MRP - Maximum Retail Price Inclusive of all taxes including GST.

Arteor™

Mounting Boxes

| Cat.Nos | Description | MRP* ₹ / Unit | Pack |
|--------------------------|--------------------------------|------------------|------|
| Metal Flush Boxes | | | |
| 6890 07 | Metal Flush Box - 1/2 Module | 170 | 40 |
| 6890 08 | Metal Flush Box - 3 Module | 170 | 40 |
| 6890 09 | Metal Flush Box - 4 Module | 226 | 40 |
| 6890 10 | Metal Flush Box - 6 Module | 358 | 40 |
| 6890 42 | Metal Flush Box - 8 Module | 416 | 40 |
| 6890 31 | Metal Flush Box - 2*4 Module | 414 | 20 |
| 6890 11 | Metal Flush Box - 12/16 Module | 624 | 10 |
| 6890 12 | Metal Flush Box - 18/24 Module | 788 | 10 |



6890 08



6890 09



6890 12



6846 38



6806 12



6806 13

IP 55 Plexo Box & Accessories

| | | | |
|---------|---|------|---|
| 6846 38 | Grey Plexo Box & Adaptor with Transparent Flap-3 Module-IP 66 | 5620 | 1 |
|---------|---|------|---|

IP 55 Plexo Box with PVC Membrane

| | | | |
|---------|---|------|----|
| 6806 11 | Grey Plexo Box & Adaptor with PVC Membrane-1 Module | 1240 | 10 |
| 6806 12 | Grey Plexo Box & Adaptor with PVC Membrane-2 Module | 1266 | 10 |
| 6806 13 | Grey Plexo Box & Adaptor with PVC Membrane-3 Module | 1684 | 10 |
| 6806 14 | Grey Plexo Box & Adaptor with PVC Membrane-4 Module | 2526 | 5 |

Bold Cat.Nos are products normally available with Legrand (India) Stockists. **Cat.Nos** that are not bold - delivery within 4 - 8 weeks from the date of order. **Bold packing quantity** is our mandatory packing. Orders to be placed by Legrand (India) Stockist in multiples of the same.

Arteor™

Mounting Boxes

| Cat.Nos | Description | MRP* ₹ / Unit | Pack |
|--|--|---------------------|------|
| IP 55 Plexo Box with PVC Membrane | | | |
| 6806 19 | Grey Plexo Box & Adaptor with PVC Membrane-2 Row*4 Module | 4096 | 5 |
| 6806 33 | Grey Plexo Flush Adaptor with Membrane-3 Module Arteor Box | 1350 | 20 |

Arteor™

Guarantee

- The Company, at its discretion, will replace products if they have any manufacturing defect within 10 years for switches (without LED lamp) and power sockets. For all other **Arteor™** wiring accessories the guarantee will be 2 years.
- The above guarantee is applicable when the devices are used in Legrand metal flush boxes. Otherwise the guarantee period will be reduced by 50%.
- The guarantee is only applicable when the products are installed as per the Company's instructions and not tampered in any manner.
- The guarantee states the Company's entire liability. It does not extend to cover consequential loss or damage or installation costs arising from defective products.

Our switches are compliant with revised BIS standard (IS 3854:2023) requirements. Also, our switches are covered additionally for use on Self-Ballasted Lamp (SBL) loads.

SBL power rating as per IS3854:2023

| Switch Rating | 6A, 230V~ | 10A, 230V~ | 16A, 230V~ | 20A, 230V~ |
|-------------------------|-----------|------------|------------|------------|
| SBL power (Watt) | 100 W | 100 W | 200 W | 250 W |

* MRP - Maximum Retail Price Inclusive of all taxes including GST.

Bold Cat.Nos are products normally available with Legrand (India) Stockists. **Cat.Nos that are not bold** - delivery within 4 - 8 weeks from the date of order. **Bold packing quantity** is our mandatory packing. Orders to be placed by Legrand (India) Stockist in multiples of the same.

ARTEOR™ IoT

Smart Homes, Smarter Convenience

Arteor™ IoT enhances the Arteor wiring device range with wireless smart controls for modern connected homes. Using Zigbee 3.0, etc technologies, it enables intelligent lighting control, curtain control, fan control, scenario management energy monitoring, scheduling.

Features

- Wireless smart controls including dimmers and scenario switches allow you to control everything wirelessly
- Voice assistant compatibility with Alexa, Google Home, and Apple HomeKit
- Home+Control app integration for setup, monitoring, and scene management

Benefits

- Adds smart, intelligent automation to premium Arteor installations
- Simplifies upgrades with wireless installation and mesh connectivity
- Enhances everyday convenience through manual, voice and Legrand Home+ Control application

Scan to know more about
the product.





THE HOME + CONTROL APP FOR SMARTPHONE OR TABLET

The app on the smartphone or tablet opens up new options: monitoring of instantaneous power consumption and control over various functions when the user is out and about.



LOCAL CONTROL GUARANTEED

Of course, all functions can still be used in the traditional way via switches on the wall. If furniture needs to be rearranged or small children need to be able to reach a switch, the wireless switches can be repositioned easily at any time.



**Home +
Control App**

iPhone, iPod and iPad are registered trademarks of Apple Inc, registered in the US and other countries. HomeKit is a trademark of Apple Inc. App store is a service mark of Apple Inc., Google, Android, Google Play, and the Google Play logo are trademarks of Google LLC. Amazon, Alexa and all related logos are trademarks of Amazon.com, Inc. or its affiliates.

Product Range



**DIMMER WITH
NEUTRAL 1M
150W**



**4 SCENARIO
CONTROL
WIRELESS SW**



**WIRELESS
2 GANG
SWITCH**



**AUXILIARY
WIRELESS
SWITCH**



**SHUTTER
MICRO
MODULE**



**PORTABLE
REMOTE**

CX³

Smart Comfort & Control from your Electrical Panel

CX³ combines smart electrical panel solutions with the Home + Control app to provide a complete system for managing residential electrical functions from anywhere. Designed for homes as well as multi-dwelling buildings, it enables convenient control of lighting, power, and other loads while delivering enhanced comfort and connectivity in everyday living.

Features

- Centralised control of lighting, power via app
- Compatible with major voice assistants
- Scalable solution for homes and multi-dwelling buildings
- Scene and schedule-based automation

Benefits

- Enables remote and voice control for enhanced home comfort
- Simplifies daily routines with personalised automation
- Adds value with smart, connected home infrastructure
- Supports flexible management for individual homes or apartments

Scan to know more about
the product.





Gateway module



Smart Contactor



Smart Latching Relay



Energy Meter



Remote Control



Voice Control



Ease of Scheduling



Smart Energy Management

Arteor™ IoT

Connected Home - White Mechanism

| Cat.Nos | Description | MRP* ₹ / Unit | Pack |
|---------|-------------|------------------|------|
|---------|-------------|------------------|------|

Connected Light Switches

| | | | |
|---------|---|-------|--------|
| 5742 01 | Connected Switch - with Neutral - Wired - 1 Module | 11626 | 1/0/24 |
| 5743 40 | Connected Switch Dimmer - with Neutral - 150 Watts - 1 Module | 13354 | 1/0/24 |

Connected Outlets

| | | | |
|---------|--|-------|--------|
| 5742 00 | 16A - Connected Socket Module - 1 Module | 13242 | 1/0/12 |
|---------|--|-------|--------|

Connected Curtain/Roller Blind Switches

| | | | |
|---------|--|-------|--------|
| 5742 04 | Connected Curtain/Roller Blind Switch - Wired - 1 Module | 14144 | 1/0/24 |
|---------|--|-------|--------|

Connected Step Fan Controller

| | | | |
|---------|---|------|------|
| 5742 48 | Connected Step Fan Controller - with Neutral -100W - 2 Module | 9794 | 1/20 |
|---------|---|------|------|

Connected Gateway Pack

| | | | |
|---------|---|-------|-------|
| 5742 09 | Connected Gateway + Master Home/Away Wireless Switch - Wired - 2 Module | 28186 | 1/0/4 |
|---------|---|-------|-------|

Wireless Control Switch

| | | | |
|---------|---|------|--------|
| 5742 05 | 1 Gang - Wireless Switch - 2 Module | 6036 | 1/0/10 |
| 5742 44 | 2 Gang - Wireless Switch - 2 Module | 6956 | 1/0/10 |
| 5742 07 | Curtain/Roller Blind Wireless Switch - 2 Module | 6962 | 1/0/10 |

Wireless Scenario Control Switch

| | | | |
|---------|---|------|--------|
| 5742 06 | Home/Away Wireless Master Switch - 2 Module | 7064 | 1/0/10 |
| 5742 08 | Wake Up/Sleep Wireless Scenario Control Switch - 2 Module | 7064 | 1/0/10 |
| 5743 12 | Wireless 4 Scenario Control Switch - 2 Module | 8822 | 1/0/10 |

Connected Home- Magnesium Mechanism Connected Light Switches

| | | | |
|---------|---|-------|--------|
| 5742 20 | Connected Switch - with Neutral - Wired - 1 Module | 13380 | 1/0/24 |
| 5743 42 | Connected Switch Dimmer - with Neutral - 150 Watts - 1 Module | 15354 | 1/0/24 |

Connected Outlets

| | | | |
|---------|--|-------|--------|
| 5742 28 | 16A - Connected Socket Module - 1 Module | 15386 | 1/0/12 |
|---------|--|-------|--------|

* MRP - Maximum Retail Price Inclusive of all taxes including GST.
Red Cat.Nos - new products

Arteor™ IoT

Connected Home - Magnesium Mechanism

| Cat.Nos | Description | MRP* ₹ / Unit | Pack |
|---------|-------------|------------------|------|
|---------|-------------|------------------|------|

Connected Curtain/Roller Blind Switches

| | | | |
|---------|--|-------|--------|
| 5742 22 | Connected Curtain/Roller Blind Switch - Wired - 1 Module | 16258 | 1/0/24 |
|---------|--|-------|--------|

Connected Step Fan Controller

| | | | |
|---------|---|-------|------|
| 5742 50 | Connected Step Fan Controller - with Neutral -100W - 2 Module | 11262 | 1/20 |
|---------|---|-------|------|

Connected Gateway Pack

| | | | |
|---------|---|-------|-------|
| 5742 27 | Connected Gateway + Master Home/Away Wireless Switch - Wired - 2 Module | 32410 | 1/0/4 |
|---------|---|-------|-------|

Wireless Control Switch

| | | | |
|---------|---|------|--------|
| 5742 23 | 1 Gang - Wireless Switch - 2 Module | 7016 | 1/0/10 |
| 5742 46 | 2 Gang - Wireless Switch - 2 Module | 7994 | 1/0/10 |
| 5742 25 | Curtain/Roller Blind Wireless Switch - 2 Module | 8006 | 1/0/10 |

Connected Wireless Scene Switches

| | | | |
|---------|---|-------|--------|
| 5742 24 | Home/Away Wireless Master Switch - 2 Module | 8130 | 1/0/10 |
| 5742 26 | Wake Up/Sleep Wireless Scenario Control Switch - 2 Module | 8130 | 1/0/10 |
| 5743 14 | Wireless 4 Scenario Control Switch - 2 Module | 10148 | 1/0/10 |

Connected Home - Champagne Mechanism Connected Light Switches

| | | | |
|---------|---|-------|--------|
| 5742 29 | Connected Switch - with Neutral - Wired - 1 Module | 13380 | 1/0/24 |
| 5743 43 | Connected Switch Dimmer - with Neutral - 150 Watts - 1 Module | 15354 | 1/0/24 |

Connected Outlets

| | | | |
|---------|--|-------|--------|
| 5742 37 | 16A - Connected Socket Module - 1 Module | 15386 | 1/0/12 |
|---------|--|-------|--------|

Connected Curtain/Roller Blind Switches

| | | | |
|---------|--|-------|--------|
| 5742 31 | Connected Curtain/Roller Blind Switch - Wired - 1 Module | 16258 | 1/0/24 |
|---------|--|-------|--------|

Connected Step Fan Controller

| | | | |
|---------|---|-------|--------|
| 5742 51 | Connected Step Fan Controller - with Neutral -100W - 2 Module | 11262 | 1/5/50 |
|---------|---|-------|--------|

Connected Gateway Pack

| | | | |
|---------|---|-------|-------|
| 5742 36 | Connected Gateway + Master Home/Away Wireless Switch - Wired - 2 Module | 32410 | 1/0/4 |
|---------|---|-------|-------|

Bold Cat.Nos are products normally available with Legrand (India) Stockists. Cat.Nos that are not bold - delivery within 4 - 8 weeks from the date of order. Bold packing quantity is our mandatory packing. Orders to be placed by Legrand (India) Stockist in multiples of the same.



5742 01



5742 00



5742 04



5742 48



5742 09



5742 07



5742 06



5742 20



5742 28



5742 27



5742 23



5742 24



5742 26



5742 29



5742 37



5742 31



5742 36

Arteor™ IoT

Connected Home - Champagne Mechanism

| Cat.Nos | Description | MRP* ₹ / Unit | Pack |
|---------|-------------|------------------|------|
|---------|-------------|------------------|------|

Wireless Control Switch

| | | | |
|---------|---|------|--------|
| 5742 32 | 1 Gang - Wireless Switch - 2 Module | 6948 | 1/0/10 |
| 5742 47 | 2 Gang - Wireless Switch - 2 Module | 7994 | 1/0/10 |
| 5742 34 | Curtain/Roller Blind Wireless Switch - 2 Module | 8006 | 1/0/10 |



5742 34

Wireless Scenario Control Switch

| | | | |
|---------|---|-------|--------|
| 5742 33 | Home/Away Wireless Master Switch - 2 Module | 8130 | 1/0/10 |
| 5742 35 | Wake Up/Sleep Wireless Scenario Control Switch - 2 Module | 8130 | 1/0/10 |
| 5743 15 | Wireless 4 Scenario Control Switch - 2 Module | 10148 | 1/0/10 |



5742 35

Micro Module Switch & Connected Accessories

| | | | |
|---------|---|-------|--------|
| 5742 43 | Micro Module Switch - with Neutral - Black | 9732 | 1/0/22 |
| 0676 97 | Shutter Micromodule | 12624 | 1 |
| 0676 94 | Wireless Switch - On/Off Module for Mechanical Switch - (Auxiliary) - Black | 11810 | 1 |
| 0676 95 | Portable Remote - Black | 15568 | 1 |

Cover plates

White Cover Plates with Overmoulded Frame

| | | | |
|---------|--|------|--------|
| 5758 98 | Cover Plate + Support Frame - 1 Module - White | 446 | 10/100 |
| 5758 99 | Cover Plate + Support Frame - 2 Module - White | 460 | 10/100 |
| 5759 60 | Cover Plate + Support Frame - 3 Module - White | 534 | 10/100 |
| 5759 65 | Cover Plate + Support Frame - 4 Module - White | 614 | 5/50 |
| 5759 94 | Cover Plate + Support Frame - 6 Module - White | 844 | 5/30 |
| 5759 95 | Cover Plate + Support Frame - 8 Module - White | 1000 | 5/30 |
| 5759 96 | Cover Plate + Support Frame - 2*4 Module - White | 1460 | 2/20 |
| 5759 97 | Cover Plate + Support Frame - 2*6 Module - White | 1938 | 2/16 |
| 5759 98 | Cover Plate + Support Frame - 2*8 Module - White | 2130 | 2/16 |
| 5759 99 | Cover Plate + Support Frame - 3*6 Module - White | 2512 | 2/16 |



5758 99



5759 65



5759 94

Pearl Aluminium Cover Plates with Overmoulded Frame

| | | | |
|---------|--|-----|--------|
| 5757 01 | Cover Plate + Support Frame - 1 Module - Pearl Aluminium | 540 | 10/100 |
| 5757 11 | Cover Plate + Support Frame - 2 Module - Pearl Aluminium | 572 | 10/100 |

* MRP - Maximum Retail Price Inclusive of all taxes including GST.
Red Cat.Nos - new products

Arteor™ IoT

Cover Plates

| Cat.Nos | Description | MRP* ₹ / Unit | Pack |
|---------|-------------|------------------|------|
|---------|-------------|------------------|------|

Pearl Aluminium Cover Plates with Overmoulded Frame

| | | | |
|---------|--|------|--------|
| 5757 21 | Cover Plate + Support Frame - 3 Module - Pearl Aluminium | 608 | 10/100 |
| 5757 31 | Cover Plate + Support Frame - 4 Module - Pearl Aluminium | 690 | 5/50 |
| 5757 41 | Cover Plate + Support Frame - 6 Module - Pearl Aluminium | 1172 | 5/30 |
| 5757 51 | Cover Plate + Support Frame - 8 Module - Pearl Aluminium | 1302 | 5/30 |
| 5757 61 | Cover Plate + Support Frame - 2*4 Module - Pearl Aluminium | 1652 | 2/20 |
| 5757 71 | Cover Plate + Support Frame - 2*6 Module - Pearl Aluminium | 2146 | 2/16 |
| 5757 81 | Cover Plate + Support Frame - 2*8 Module - Pearl Aluminium | 2438 | 2/16 |
| 5757 91 | Cover Plate + Support Frame - 3*6 Module - Pearl Aluminium | 2852 | 2/12 |



5757 21



5757 61

Graphite Cover Plates with Overmoulded Frame

| | | | |
|---------|---|------|--------|
| 5757 02 | Cover Plate + Support Frame - 1 Module - Graphite | 540 | 10/100 |
| 5757 12 | Cover Plate + Support Frame - 2 Module - Graphite | 572 | 10/100 |
| 5757 22 | Cover Plate + Support Frame - 3 Module - Graphite | 608 | 10/100 |
| 5757 32 | Cover Plate + Support Frame - 4 Module - Graphite | 690 | 5/50 |
| 5757 42 | Cover Plate + Support Frame - 6 Module - Graphite | 1172 | 5/30 |
| 5757 52 | Cover Plate + Support Frame - 8 Module - Graphite | 1302 | 5/30 |
| 5757 62 | Cover Plate + Support Frame - 2*4 Module - Graphite | 1652 | 2/20 |
| 5757 72 | Cover Plate + Support Frame - 2*6 Module - Graphite | 2146 | 2/16 |
| 5757 82 | Cover Plate + Support Frame - 2*8 Module - Graphite | 2438 | 2/16 |
| 5757 92 | Cover Plate + Support Frame - 3*6 Module - Graphite | 2852 | 2/12 |



5757 22



5757 42

Magnesium Cover Plates with Overmoulded Frame

| | | | |
|---------|--|-----|--------|
| 5758 11 | Cover Plate + Support Frame - 1 Module - Magnesium | 540 | 10/100 |
| 5758 12 | Cover Plate + Support Frame - 2 Module - Magnesium | 572 | 10/100 |

Bold Cat.Nos are products normally available with Legrand (India) Stockists. Cat.Nos that are not bold - delivery within 4 - 8 weeks from the date of order. Bold packing quantity is our mandatory packing. Orders to be placed by Legrand (India) Stockist in multiples of the same.

Arteor™ IoT

Cover Plates

| Cat.Nos | Description | MRP* ₹ / Unit | Pack |
|---------|-------------|------------------|------|
|---------|-------------|------------------|------|

Magnesium Cover Plates with Overmoulded Frame

| | | | |
|---------|--|------|--------|
| 5758 13 | Cover Plate + Support Frame - 3 Module - Magnesium | 608 | 10/100 |
| 5758 14 | Cover Plate + Support Frame - 4 Module - Magnesium | 690 | 5/50 |
| 5758 15 | Cover Plate + Support Frame - 6 Module - Magnesium | 1172 | 5/30 |
| 5758 16 | Cover Plate + Support Frame - 8 Module - Magnesium | 1302 | 5/30 |
| 5758 17 | Cover Plate + Support Frame - 2*4 Module - Magnesium | 1652 | 2/20 |
| 5758 18 | Cover Plate + Support Frame - 2*6 Module - Magnesium | 2146 | 2/16 |
| 5758 19 | Cover Plate + Support Frame - 2*8 Module - Magnesium | 2438 | 2/16 |
| 5758 20 | Cover Plate + Support Frame - 3*6 Module - Magnesium | 2852 | 2/12 |

Champagne Cover Plates with Overmoulded Frame

| | | | |
|---------|--|------|--------|
| 5758 22 | Cover Plate + Support Frame - 1 Module - Champagne | 540 | 10/100 |
| 5758 23 | Cover Plate + Support Frame - 2 Module - Champagne | 572 | 10/100 |
| 5758 24 | Cover Plate + Support Frame - 3 Module - Champagne | 608 | 10/100 |
| 5758 25 | Cover Plate + Support Frame - 4 Module - Champagne | 690 | 5/50 |
| 5758 26 | Cover Plate + Support Frame - 6 Module - Champagne | 1172 | 5/30 |
| 5758 27 | Cover Plate + Support Frame - 8 Module - Champagne | 1302 | 5/30 |
| 5758 28 | Cover Plate + Support Frame - 2*4 Module - Champagne | 1652 | 2/20 |
| 5758 29 | Cover Plate + Support Frame - 2*6 Module - Champagne | 2146 | 2/16 |
| 5758 30 | Cover Plate + Support Frame - 2*8 Module - Champagne | 2438 | 2/16 |
| 5758 31 | Cover Plate + Support Frame - 3*6 Module - Champagne | 2852 | 2/12 |

Dark Bronze Cover Plates with Overmoulded Frame

| | | | |
|---------|--|-----|--------|
| 5758 33 | Cover Plate + Support Frame - 1 Module - Dark Bronze | 540 | 10/100 |
|---------|--|-----|--------|

Arteor™ IoT

Cover Plates

| Cat.Nos | Description | MRP* ₹ / Unit | Pack |
|---------|-------------|------------------|------|
|---------|-------------|------------------|------|

Dark Bronze Cover Plates with Overmoulded Frame

| | | | |
|---------|--|------|--------|
| 5758 34 | Cover Plate + Support Frame - 2 Module - Dark Bronze | 572 | 10/100 |
| 5758 35 | Cover Plate + Support Frame - 3 Module - Dark Bronze | 608 | 10/100 |
| 5758 36 | Cover Plate + Support Frame - 4 Module - Dark Bronze | 690 | 5/50 |
| 5758 37 | Cover Plate + Support Frame - 6 Module - Dark Bronze | 1172 | 5/30 |
| 5758 38 | Cover Plate + Support Frame - 8 Module - Dark Bronze | 1302 | 5/30 |
| 5758 39 | Cover Plate + Support Frame - 2*4 Module - Dark Bronze | 1652 | 2/20 |
| 5758 40 | Cover Plate + Support Frame - 2*6 Module - Dark Bronze | 2146 | 2/16 |
| 5758 41 | Cover Plate + Support Frame - 2*8 Module - Dark Bronze | 2438 | 2/16 |
| 5758 42 | Cover Plate + Support Frame - 3*6 Module - Dark Bronze | 2852 | 2/12 |

Mirror Finish Cover Plates With Overmoulded Frame

Mirror Black Cover Plates With Overmoulded Frame

| | | | |
|---------|---|-------|--------|
| 5757 03 | Cover Plate + Support Frame - 1 Module - Mirror Black | 2756 | 1/5/30 |
| 5757 13 | Cover Plate + Support Frame - 2 Module - Mirror Black | 2948 | 1/5/30 |
| 5757 23 | Cover Plate + Support Frame - 3 Module - Mirror Black | 3158 | 1/20 |
| 5757 33 | Cover Plate + Support Frame - 4 Module - Mirror Black | 3354 | 1/20 |
| 5757 43 | Cover Plate + Support Frame - 6 Module - Mirror Black | 6106 | 1/5 |
| 5757 53 | Cover Plate + Support Frame - 8 Module - Mirror Black | 6726 | 1/5 |
| 5757 63 | Cover Plate + Support Frame - 2*4 Module - Mirror Black | 8524 | 1/10 |
| 5757 73 | Cover Plate + Support Frame - 2*6 Module - Mirror Black | 10486 | 1/8 |

Mirror White Cover Plates with Overmoulded Frame

| | | | |
|---------|---|------|--------|
| 5757 04 | Cover Plate + Support Frame - 1 Module - Mirror White | 2756 | 1/5/30 |
| 5757 14 | Cover Plate + Support Frame - 2 Module - Mirror White | 2948 | 1/5/30 |
| 5757 24 | Cover Plate + Support Frame - 3 Module - Mirror White | 3158 | 1/20 |

* MRP - Maximum Retail Price Inclusive of all taxes including GST.

Bold Cat.Nos are products normally available with Legrand (India) Stockists. Cat.Nos that are not bold - delivery within 4 - 8 weeks from the date of order. Bold packing quantity is our mandatory packing. Orders to be placed by Legrand (India) Stockist in multiples of the same.

Arteor™ IoT

Cover Plates

| Cat.Nos | Description | MRP* ₹ / Unit | Pack |
|---------|-------------|------------------|------|
|---------|-------------|------------------|------|

Mirror White Cover Plates with Overmoulded Frame

| | | | |
|---------|---|-------|------|
| 5757 34 | Cover Plate + Support Frame - 4 Module - Mirror White | 3354 | 1/20 |
| 5757 44 | Cover Plate + Support Frame - 6 Module - Mirror White | 6106 | 1/5 |
| 5757 54 | Cover Plate + Support Frame - 8 Module - Mirror White | 6726 | 1/5 |
| 5757 64 | Cover Plate + Support Frame - 2*4 Module - Mirror White | 8680 | 1/10 |
| 5757 74 | Cover Plate + Support Frame - 2*6 Module - Mirror White | 10486 | 1/8 |



5757 74

Mirror Green Apple Cover Plates with Overmoulded Frame

| | | | |
|---------|--|-------|--------|
| 5758 44 | Cover Plate + Support Frame - 1 Module - Green Apple | 2756 | 1/5/30 |
| 5758 45 | Cover Plate + Support Frame - 2 Module - Green Apple | 2948 | 1/5/30 |
| 5758 46 | Cover Plate + Support Frame - 3 Module - Green Apple | 3158 | 1/20 |
| 5758 47 | Cover Plate + Support Frame - 4 Module - Green Apple | 3354 | 1/20 |
| 5758 48 | Cover Plate + Support Frame - 6 Module - Green Apple | 6106 | 1/5 |
| 5758 49 | Cover Plate + Support Frame - 8 Module - Green Apple | 6726 | 1/5 |
| 5758 50 | Cover Plate + Support Frame - 2*4 Module - Green Apple | 8678 | 1/10 |
| 5758 51 | Cover Plate + Support Frame - 2*6 Module - Green Apple | 10486 | 1/8 |



5758 45

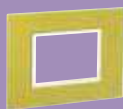

5758 46

Graphic Casual Cover Plates with Overmoulded Frame

| | | | |
|---------|---|-------|--------|
| 5762 91 | Cover Plate + Support Frame - 1 Module - Graphic Casual | 3346 | 1/5/30 |
| 5763 11 | Cover Plate + Support Frame - 2 Module - Graphic Casual | 3600 | 1/5/30 |
| 5763 31 | Cover Plate + Support Frame - 3 Module - Graphic Casual | 3868 | 1/20 |
| 5763 51 | Cover Plate + Support Frame - 4 Module - Graphic Casual | 4128 | 1/20 |
| 5763 81 | Cover Plate + Support Frame - 6 Module - Graphic Casual | 7474 | 1/5 |
| 5764 01 | Cover Plate + Support Frame - 8 Module - Graphic Casual | 8244 | 1/5 |
| 5758 89 | Cover Plate + Support Frame - 2*4 Module - Graphic Casual | 10380 | 1/10 |



5763 31



5758 54



5758 55



5758 63



5758 64



5762 90

Arteor™ IoT

Cover Plates

| Cat.Nos | Description | MRP* ₹ / Unit | Pack |
|---------|-------------|------------------|------|
|---------|-------------|------------------|------|

Graphic Casual Cover Plates with Overmoulded Frame

| | | | |
|---------|---|-------|-----|
| 5758 90 | Cover Plate + Support Frame - 2*6 Module - Graphic Casual | 12850 | 1/8 |
|---------|---|-------|-----|

Silver Baroque Cover Plates with Overmoulded Frame

| | | | |
|---------|---|-------|--------|
| 5758 53 | Cover Plate + Support Frame - 1 Module - Silver Baroque | 3346 | 1/5/30 |
| 5758 54 | Cover Plate + Support Frame - 2 Module - Silver Baroque | 3600 | 1/5/30 |
| 5758 55 | Cover Plate + Support Frame - 3 Module - Silver Baroque | 3868 | 1/20 |
| 5758 56 | Cover Plate + Support Frame - 4 Module - Silver Baroque | 4128 | 1/20 |
| 5758 57 | Cover Plate + Support Frame - 6 Module - Silver Baroque | 7474 | 1/5 |
| 5758 58 | Cover Plate + Support Frame - 8 Module - Silver Baroque | 8244 | 1/5 |
| 5758 59 | Cover Plate + Support Frame - 2*4 Module - Silver Baroque | 10380 | 1/10 |
| 5758 60 | Cover Plate + Support Frame - 2*6 Module - Silver Baroque | 12850 | 1/8 |

Dark Baroque Cover Plates with Overmoulded Frame

| | | | |
|---------|---|-------|--------|
| 5758 62 | Cover Plate + Support Frame - 1 Module - Dark Baroque | 3346 | 1/5/30 |
| 5758 63 | Cover Plate + Support Frame - 2 Module - Dark Baroque | 3600 | 1/5/30 |
| 5758 64 | Cover Plate + Support Frame - 3 Module - Dark Baroque | 3868 | 1/20 |
| 5758 65 | Cover Plate + Support Frame - 4 Module - Dark Baroque | 4128 | 1/20 |
| 5758 66 | Cover Plate + Support Frame - 6 Module - Dark Baroque | 7474 | 1/5 |
| 5758 67 | Cover Plate + Support Frame - 8 Module - Dark Baroque | 8244 | 1/5 |
| 5758 68 | Cover Plate + Support Frame - 2*4 Module - Dark Baroque | 10378 | 1/10 |
| 5758 69 | Cover Plate + Support Frame - 2*6 Module - Dark Baroque | 12850 | 1/8 |

Metal Finish Cover Plates with Overmoulded Frame Gold Brass Cover Plates with Overmoulded Frame

| | | | |
|---------|---|------|--------|
| 5762 90 | Cover Plate + Support Frame - 1 Module - Gold Brass | 4492 | 1/5/30 |
| 5763 10 | Cover Plate + Support Frame - 2 Module - Gold Brass | 4808 | 1/5/30 |

* MRP - Maximum Retail Price Inclusive of all taxes including GST.

Bold Cat.Nos are products normally available with Legrand (India) Stockists. Cat.Nos that are not bold - delivery within 4 - 8 weeks from the date of order. Bold packing quantity is our mandatory packing. Orders to be placed by Legrand (India) Stockist in multiples of the same.

Arteor™ IoT

Cover Plates

| Cat.Nos | Description | MRP* ₹ / Unit | Pack |
|---------|-------------|------------------|------|
|---------|-------------|------------------|------|

Metal Finish Cover Plates with Overmoulded Frame

Gold Brass Cover Plates with Overmoulded Frame

| | | | |
|---------|---|-------|------|
| 5763 30 | Cover Plate + Support Frame - 3 Module - Gold Brass | 5172 | 1/20 |
| 5763 50 | Cover Plate + Support Frame - 4 Module - Gold Brass | 5486 | 1/20 |
| 5763 80 | Cover Plate + Support Frame - 6 Module - Gold Brass | 9986 | 1/5 |
| 5764 00 | Cover Plate + Support Frame - 8 Module - Gold Brass | 10976 | 1/5 |



5763 30

Stainless Steel Cover Plates with Overmoulded Frame

| | | | |
|---------|--|-------|--------|
| 5757 06 | Cover Plate + Support Frame - 1 Module - Stainless Steel | 4492 | 1/5/30 |
| 5757 16 | Cover Plate + Support Frame - 2 Module - Stainless Steel | 4808 | 1/5/30 |
| 5757 26 | Cover Plate + Support Frame - 3 Module - Stainless Steel | 5172 | 1/20 |
| 5757 36 | Cover Plate + Support Frame - 4 Module - Stainless Steel | 5486 | 1/20 |
| 5757 46 | Cover Plate + Support Frame - 6 Module - Stainless Steel | 9986 | 1/5 |
| 5757 66 | Cover Plate + Support Frame - 2*4 Module - Stainless Steel | 13878 | 1/10 |
| 5757 56 | Cover Plate + Support Frame - 8 Module - Stainless Steel | 10976 | 1/5 |
| 5757 76 | Cover Plate + Support Frame - 2*6 Module - Stainless Steel | 17104 | 1/8 |



5757 16

Wood Cover Plates with Overmoulded Frame

| | | | |
|---------|---|------|--------|
| 5758 80 | Cover Plate + Support Frame - 1 Module - Grey Oak | 2632 | 1/5/30 |
| 5758 81 | Cover Plate + Support Frame - 2 Module - Grey Oak | 2792 | 1/5/30 |
| 5758 82 | Cover Plate + Support Frame - 3 Module - Grey Oak | 3446 | 1/20 |



5758 81

* MRP - Maximum Retail Price Inclusive of all taxes including GST.

Arteor™ IoT

Cover Plates

| Cat.Nos | Description | MRP* ₹ / Unit | Pack |
|---------|-------------|------------------|------|
|---------|-------------|------------------|------|

Wood Cover Plates with Overmoulded Frame

| | | | |
|---------|---|-------|------|
| 5758 83 | Cover Plate + Support Frame - 4 Module - Grey Oak | 3820 | 1/20 |
| 5758 84 | Cover Plate + Support Frame - 6 Module - Grey Oak | 5672 | 1/5 |
| 5758 85 | Cover Plate + Support Frame - 8 Module - Grey Oak | 6822 | 1/5 |
| 5758 86 | Cover Plate + Support Frame - 2*4 Module - Grey Oak | 8102 | 1/10 |
| 5758 87 | Cover Plate + Support Frame - 2*6 Module - Grey Oak | 10856 | 1/8 |



5758 72



5758 73

Signature Cover Plates with Overmoulded Frame

| | | | |
|---------|---|-------|--------|
| 5758 71 | Cover Plate + Support Frame - 1 Module - Cube Plate | 8610 | 1/5/30 |
| 5758 72 | Cover Plate + Support Frame - 2 Module - Cube Plate | 8764 | 1/5/30 |
| 5758 73 | Cover Plate + Support Frame - 3 Module - Cube Plate | 10024 | 1/20 |
| 5758 74 | Cover Plate + Support Frame - 4 Module - Cube Plate | 10358 | 1/20 |
| 5758 75 | Cover Plate + Support Frame - 6 Module - Cube Plate | 13492 | 1/5 |
| 5758 76 | Cover Plate + Support Frame - 8 Module - Cube Plate | 14158 | 1/5 |
| 5758 77 | Cover Plate + Support Frame - 2*4 Module - Cube Plate | 21154 | 1/10 |
| 5758 78 | Cover Plate + Support Frame - 2*6 Module - Cube Plate | 23434 | 1/8 |

Cover Plates Without Frame

| | | | |
|-----------|--|-----|------|
| 5757 10PL | Cover Plate without Frame for Wireless Switch-2 Module-White | 218 | 5/50 |
| 5757 11PL | Cover Plate without Frame for Wireless Switch-2 Module-Pearl Aluminium | 440 | 5/50 |



5757 10



5757 11

Bold Cat.Nos are products normally available with Legrand (India) Stockists. Cat.Nos that are not bold - delivery within 4 - 8 weeks from the date of order. Bold packing quantity is our mandatory packing. Orders to be placed by Legrand (India) Stockist in multiples of the same.

Arteor™ IoT

Cover Plates

| Cat.Nos | Description | MRP* ₹ / Unit | Pack |
|---------|-------------|---------------------|------|
|---------|-------------|---------------------|------|

Cover Plates Without Frame

| | | | |
|-----------|--|-----|------|
| 5757 12PL | Cover Plate without Frame for Wireless Switch-2 Module-Graphite | 348 | 5/50 |
| 5758 12PL | Cover Plate without Frame for Wireless Switch-2 Module-Magnesium | 440 | 5/50 |
| 5758 23PL | Cover Plate without Frame for Wireless Switch-2 Module-Champagne | 440 | 5/50 |
| 5758 34PL | Cover Plate without Frame for Wireless Switch-2 Module-Dark Bronze | 440 | 5/50 |

Accessory

| | | | |
|---------|--|-----|------|
| 0648 71 | Pack of 3*4 Extra Removable Stickers for Fixing A Wireless Control | 806 | 1/25 |
|---------|--|-----|------|



5757 12

* MRP - Maximum Retail Price Inclusive of all taxes including GST.

Bold Cat.Nos are products normally available with Legrand (India) Stockists. Cat.Nos that are not bold - delivery within 4 - 8 weeks from the date of order. Bold packing quantity is our mandatory packing. Orders to be placed by Legrand (India) Stockist in multiples of the same.

Myrius™

A Perfect Blend of Design & Convenience



Myrius™ is designed to enhance modern living spaces by combining refined aesthetics with everyday usability. It brings together thoughtful design and intuitive functionality to create a seamless and comfortable user experience.

Features

- In-Mould decoration (IMD) technology enabling customised smart functions
- Integrated smart functionality for enhanced control and convenience
- Wide range of designer finishes to suit diverse interior styles
- Available in 11 premium plate finish options

Benefits

- Elevates interiors with distinctive designer aesthetics
- Enables personalised living through customised smart features
- Offers flexibility in design with a wide range of finishes
- Enhances everyday convenience with intuitive functionality

Scan to know more about the product.



Myrius: The best of both worlds

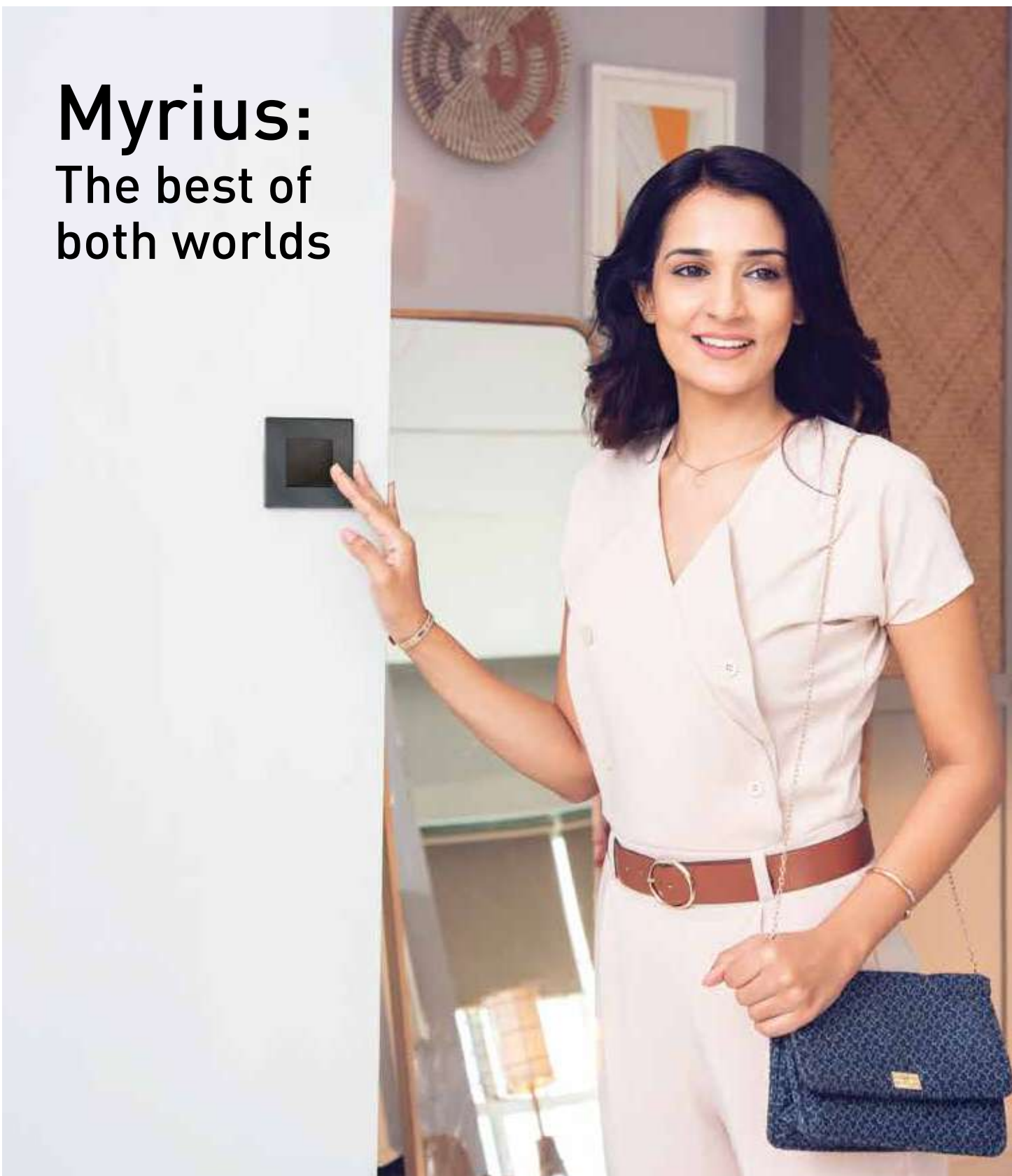

Myrius™

Premium Glass Finish for Modern Interiors



MYRIUS GLASS FINISH

Myrius™ Glass plate enhances interior spaces with sleek glass finishes and a refined flush design, bringing a modern and sophisticated aesthetic to premium environments.

Features

- 3 mm toughened glass finishes available in white and black
- Plate range from 1 to 18 modules for design flexibility
- Available in multiple colour options

Benefits

- Enhances interior aesthetics with elegant and modern glass finishes
- Adds a modern and sophisticated look to spaces
- Ensures design flexibility across different layouts



Myrius™

Designed for Hygiene.
Built for Everyday
Living.



ANTI-BACTERIAL RANGE

Myrius™ Anti-Bacterial Range is designed to support healthier living by reducing bacterial presence on frequently touched surfaces, combining hygiene with modern design for everyday spaces.

Features

- Silver ion-infused surfaces for antibacterial protection
- Smooth finish for easy cleaning and maintenance
- Certified antibacterial performance
- Contemporary design suitable for modern interiors

Benefits

- Reduces bacterial presence on frequently touched surfaces
- Supports a healthier home environment
- Enhances everyday safety through hygienic materials
- Combines hygiene with modern aesthetics



Myrius™

Cover Plates Cover Plates

| Cat.Nos | Description | MRP* ₹ / Unit | Pack |
|---------|-------------|------------------|------|
|---------|-------------|------------------|------|

Switches 6A - 230V AC

| | | | |
|---------|---|-----|----------|
| 6792 00 | 6A - Switch - 1 Way - 1 Module | 160 | 1/20/200 |
| 6792 01 | 6A - Switch - 2 Way - 1 Module | 292 | 1/20/200 |
| 6792 02 | 6A - Switch - 1 Way - with Indicator - 1 Module | 270 | 1/20/200 |
| 6792 03 | 6A - Switch - 1 Way - with "Light" Marking - 1 Module | 230 | 1/20/200 |
| 6792 04 | 6A - Switch - 1 Way - with "Fan" Marking - 1 Module | 230 | 1/20/200 |

Switches - 10A - 230V AC

| | | | |
|---------|--|------|----------|
| 6793 00 | 10A - Switch - 1 Way - 1 Module | 170 | 20/200 |
| 6793 01 | 10A - Switch - 2 Way - 2 Module | 298 | 20/200 |
| 6793 02 | 10A - Switch - 1 Way - with Indicator - 1 Module | 278 | 20/200 |
| 6792 05 | 10A - Switch - 1 Way - 2 Module | 344 | 1/10/100 |
| 6792 06 | 10A - Switch - 2 Way - 2 Module | 408 | 1/10/100 |
| 6792 07 | 10A - Intermediate Switch - 230V AC - 2 Module | 2220 | 1/10/100 |
| 6792 08 | 10A - Switch - 1 Way - with Indicator - 2 Module | 426 | 1/10/100 |

Switches - 16A - 230V AC

| | | | |
|---------|--|-----|----------|
| 6792 09 | 16A - Switch - 1 Way - 1 Module | 388 | 1/20/200 |
| 6792 10 | 16A - Switch - 2 Way - 1 Module | 440 | 1/20/200 |
| 6792 11 | 16A - Switch - 1 Way - with Indicator - 1 Module | 468 | 1/20/200 |

Switches - 20A - 230V AC

| | | | |
|---------|---|-----|----------|
| 6792 12 | 20A - Switch - 1 Way - 1 Module | 512 | 1/20/200 |
| 6792 13 | 20A - Switch - DP - 1 Way - 2 Module | 784 | 1/10/100 |
| 6792 14 | 20A - Switch - DP - 1 Way - with Indicator - 2 Module | 838 | 1/10/100 |
| 6792 15 | 20A - Switch - 2 Way - 2 Module | 864 | 1/10/100 |

Switches - 25A - 230V AC

| | | | |
|---------|---|-----|----------|
| 6792 16 | 25A - Switch - SP - 1 Way - with Indicator - 1 Module | 576 | 1/20/200 |
|---------|---|-----|----------|

Switches - 32A - 230V AC

| | | | |
|---------|---|------|----------|
| 6792 17 | 32A - Switch - DP - with Indicator - 2 Module | 1284 | 1/10/100 |
|---------|---|------|----------|

Myrius™

Classic White Mechanism

| Cat.Nos | Description | MRP* ₹ / Unit | Pack |
|---------|-------------|------------------|------|
|---------|-------------|------------------|------|

Push Button - 6A - 230V AC

| | | | |
|---------|---|-----|----------|
| 6792 18 | 6A - Push Button - SP - 1 Module | 324 | 1/20/200 |
| 6792 19 | 6A - Push Button - SP - 1 Way - with Indicator - 1 Module | 426 | 1/20/200 |
| 6792 20 | 6A - Bell Push - 1 Way - 1 Module | 326 | 1/20/200 |
| 6792 21 | 6A - Bell Push - 1 Way - with Indicator - 1 Module | 426 | 1/20/200 |
| 6792 22 | 6A - Bell Push - 1 Way - 2 Module | 494 | 1/10/100 |
| 6792 23 | 6A - Bell Push - 1 Way - with Indicator - 2 Module | 576 | 1/10/100 |

Accessories for Switches

| | | | |
|---------|-----------------------------|----|--------|
| 6792 24 | Lamp for Switches - 230V AC | 80 | 1/5/50 |
|---------|-----------------------------|----|--------|

Indian Standard Socket

| | | | |
|---------|---|------|----------|
| 6792 35 | 6A - Socket - with Shutter - 3 Pin - ISI - 2 Module | 278 | 1/20/200 |
| 6792 30 | 6/16A - Socket - with Shutter - ISI - 2 Module | 592 | 1/10/100 |
| 6792 29 | 6/16A - Socket - with Shutter - ISI - 3 Module | 708 | 1/5/50 |
| 6792 26 | 16A - Switch Socket - with Shutter - 3 Pin - 3 Module | 1538 | 1/5/50 |

Dimmers & Fan Regulators

| | | | |
|---------|---|------|----------|
| 6792 36 | Rotary Dimmer - 400 Watts - 1 Module | 1504 | 5/50 |
| 6792 37 | Rotary Light Dimmer - 500 Watts - 2 Module | 2270 | 10/100 |
| 6792 39 | Fan Regulator - 100 Watts - ISI - 1 Module | 1168 | 5/50 |
| 6792 40 | Fan Regulator - 100 Watts - 360° - ISI - 2 Module | 1340 | 10/100 |
| 6792 41 | Fan Regulator - 120 Watts - 360° - ISI - 2 Module | 1446 | 10/100 |
| 6792 42 | Fan Regulator - 70 Watts - ISI - 2 Module | 1402 | 1/10/100 |
| 6792 31 | Fan Regulator - 8 Step - 100 Watts ISI - 2 Module | 1224 | 10/100 |
| 6792 96 | Fan Regulator - BLDC - 2 Module [^] | 1426 | 10/100 |

* MRP - Maximum Retail Price Inclusive of all taxes including GST.

[^] Compatible with Atomberg (Efficio), Havells (Eficiencia neo), Orient (Aerostorm) as per 2023 fan models.

Bold Cat.Nos are products normally available with Legrand (India) Stockists. Cat.Nos that are not bold - delivery within 4 - 8 weeks from the date of order. Bold packing quantity is our mandatory packing. Orders to be placed by Legrand (India) Stockist in multiples of the same.

Myrius™

Classic White Mechanism

| Cat.Nos | Description | MRP ₹ / Unit | Pack |
|---------|-------------|--------------------|------|
|---------|-------------|--------------------|------|

Emergency Light

| | | | |
|---------|---|------|----------|
| 6792 43 | Emergency Removable LED Lamp - 2 Module | 3742 | 1/10/100 |
|---------|---|------|----------|

Skirting Light

| | | | |
|---------|---|------|--------|
| 6792 48 | Skirting Light - with Warm White LED - 3 Module | 1132 | 1/5/25 |
|---------|---|------|--------|

Indicator

| | | | |
|---------------------|--|-----|----------|
| NEW! 6792 97 | Indicator Unit - with Transparent LED - 1 Module | 626 | 1/10/100 |
|---------------------|--|-----|----------|

Bell Call Indicator

| | | | |
|---------|--------------------------------|------|----------|
| 6792 49 | Bell Call Indicator - 1 Module | 1492 | 1/20/200 |
|---------|--------------------------------|------|----------|

Buzzer

| | | | |
|---------|--------------------------|------|----------|
| 6792 50 | Buzzer - 230V - 1 Module | 1378 | 1/20/200 |
|---------|--------------------------|------|----------|

Infrared Sensors

| | | | |
|---------|---|------|------|
| 6792 51 | Infrared Sensor Switch - 400 Watts - 2 Module | 2632 | 1/50 |
|---------|---|------|------|

Remote Unit

| | | | |
|---------|--|------|--------|
| 6792 52 | Remote Control Unit - for Light & Fan - 4 Module | 8988 | 1/5/20 |
| 6793 03 | Remote Control Hand Unit | 794 | 1/5/30 |

Hospitality Function

Hotel Keycard Switch

| | | | |
|---------|----------------------------------|------|----------|
| 6792 53 | 16A - Key Card Switch - 2 Module | 5390 | 1/10 |
| 6792 55 | Key Fob for Key Card Switch | 234 | 1/10/100 |

Hotel "DND and MMR" Functions

| | | | |
|---------|---|------|----------|
| 6792 56 | External DND & MMR Control Unit - with Bell Push - 2 Module | 2298 | 1/10/100 |
| 6792 57 | Internal DND & MMR Control Unit - 2 Module | 1534 | 1/10/100 |

Shaver Socket

| | | | |
|---------|---|------|--------|
| 6792 58 | Shaver Socket - 110/230V AC - Monoblock with Plate - 2 Module | 4012 | 1/16 |
| 6792 59 | Shaver Socket - 110/230V AC - Monoblock with Plate - 4 Module | 6552 | 1/5/20 |

Tv Sockets

| | | | |
|---------|---------------------------------|-----|----------|
| 6792 60 | TV Co - axial Socket - 1 Module | 302 | 1/20/200 |
|---------|---------------------------------|-----|----------|

Data & Voice

| | | | |
|---------|---|------|----------|
| 6792 62 | Telephone Socket - RJ11 - 1 Module | 298 | 1/20/200 |
| 6792 63 | Telephone Socket - Double RJ11 - 1 Module | 460 | 1/20/200 |
| 6792 64 | Information Socket - RJ45 - Cat 5E - UTP - Toolless with Shutter - 1 Module | 609 | 1/20/200 |
| 6792 65 | Information Socket - RJ45 - Cat 6 - UTP - Toolless with Shutter - 1 Module | 907 | 1/20/200 |
| 6792 66 | Information Socket - RJ45 - Cat 6 - UTP - Toolless with Shutter - 2 Module | 925 | 1/10/100 |
| 6797 13 | Information Socket - RJ45 - Cat 6A - STP - 1 Module | 1065 | 20/200 |

Myrius™

Classic White Mechanism

| Cat.Nos | Description | MRP ₹ / Unit | Pack |
|---------|-------------|--------------------|------|
|---------|-------------|--------------------|------|

Audio Video Connectors

| | | | |
|---------|--|------|------|
| 6792 67 | Preterminated Audio/Video Connector - 1 Module | 2399 | 1/10 |
| 6792 68 | Preterminated Projector Connector - 1 Module | 2939 | 1/10 |
| 6792 69 | Preterminated HDMI Socket - 1 Module | 2939 | 1/10 |

Sound (Volume Controller)

| | | | |
|---------|------------------------------|------|----------|
| 6792 70 | Volume Controller - 2 Module | 1795 | 1/10/100 |
|---------|------------------------------|------|----------|

Protectors & Accessories

Motor Starter

| | | | |
|---------|--------------------------------|-----|----------|
| 6792 71 | 16A - Motor Starter - 2 Module | 952 | 1/10/100 |
| 6792 72 | 25A - Motor Starter - 2 Module | 972 | 1/10/100 |

Electronic Function

USB Chargers (IS13252(Part 1) / IEC 60950-1)

| | | | |
|---------------------|---|-------|----------|
| 6792 88 | USB Charger - 1500mA - Type A - 1 Module | 2056 | 1/5/50 |
| 6792 89 | USB Charger - 3000mA - Type A + C - 2 Module | 3180 | 1/10/100 |
| 6797 51 | USB Charger - 3000mA/15 Watts - Type A - 1 Module | 2376 | 1/5/50 |
| 6797 52 | USB Charger - 3000mA/15 Watts - Type A + A - 1 Module | 2676 | 1/5/50 |
| 6797 53 | USB Charger - 3000mA/15 Watts - Type A + C - 1 Module | 3408 | 1/5/50 |
| 6797 54 | USB Charger - 3000mA/15 Watts - Type C + C - 1 Module | 3722 | 1/5/50 |
| 6797 55 | USB Charger - Power Delivery - 20 Watts - Type C - 1 Module | 4534 | 1/5/50 |
| 6792 73 | USB Charger - Power Delivery - 30 Watts - Type C + C - 2 Module | 6878 | 1/3/30 |
| 6797 57 | USB Charger - Power Delivery - 45 Watts - Type C - 2 Module | 8966 | 1/3/30 |
| NEW! 6797 59 | USB Charger - Power Delivery - 65 Watts - Type C + C - 3 Module | 11058 | 1/5/20 |

Loud Speakers

| | | | |
|---------|-------------------------------------|------|-----|
| 6792 98 | Ceiling Loudspeaker - 8Ohms - 100mm | 3759 | 1/6 |
|---------|-------------------------------------|------|-----|

Sound Diffusion

| | | | |
|---------|--------------------------------------|------|----------|
| 6792 99 | Bluetooth Sound Diffusion - 2 Module | 7697 | 1/10/100 |
|---------|--------------------------------------|------|----------|

Rotary Dimmer Universal

| | | | |
|---------|---|------|----------|
| 6793 04 | Rotary LED Light Dimmer - 50 Watts - 1 Module | 3110 | 1/10/120 |
|---------|---|------|----------|

* MRP - Maximum Retail Price Inclusive of all taxes including GST.
Red Cat. Nos - New Products

Bold Cat.Nos are products normally available with Legrand (India) Stockists. Cat.Nos that are not bold - delivery within 4 - 8 weeks from the date of order. Bold packing quantity is our mandatory packing. Orders to be placed by Legrand (India) Stockist in multiples of the same.

Myrius™

Classic White Mechanism

| Cat.Nos | Description | MRP* ₹ / Unit | Pack |
|---------|-------------|------------------|------|
|---------|-------------|------------------|------|

Touch Switches

| | | | |
|---------|--|------|------|
| 6793 08 | Touch Switch - 2 Switch - 1 Way - 1000 Watts - 2 Module - Silver | 4350 | 1/50 |
| 6793 09 | Touch Switch - 1 Way - 1440 Watts - 2 Module - Silver | 4350 | 1/50 |
| 6793 10 | Touch Switch - 2 Way - 1000 Watts - 2 Module - Silver | 5030 | 1/50 |
| 6793 13 | Touch Switch - 1 Way - 3000 Watts - 2 Module - Silver | 5030 | 1/50 |
| 6793 06 | Touch Switch - Bell Push - 1440 Watts - 2 Module - Silver | 4350 | 1/50 |

Touch Regulator, Curtain & Dimmer

| | | | |
|---------|---|------|------|
| 6793 07 | Touch Switch - Curtain Controller - 2 Module - Silver | 5030 | 1/50 |
| 6793 05 | Touch Fan Regulator - 100 Watts - 2 Module - Silver | 5030 | 1/50 |
| 6793 15 | Universal LED Touch Scroll Dimmer - 300 Watts - 2 Module - Silver | 4976 | 1/50 |

Reading Light

| | | | |
|---------|------------------------------|------|------|
| 6793 16 | Reading Light LED - 2 Module | 3110 | 1/10 |
|---------|------------------------------|------|------|

Accessories

| | | | |
|---------|-------------------------------|-----|----------|
| 6792 75 | Cable Outlet - 8mm - 1 Module | 336 | 1/20/200 |
| 6792 76 | Blanking Plate - 1 Module | 62 | 1/40/400 |
| 6792 77 | Blanking Plate - 2 Module | 72 | 1/10/100 |

Charcoal Grey- Mechanism

Switches - 6A - 230V AC

| | | | |
|---------|---|-----|----------|
| 6794 00 | 6A - Switch - 1 Way - 1 Module | 198 | 1/20/200 |
| 6794 01 | 6A - Switch - 2 Way - 1 Module | 324 | 1/20/200 |
| 6794 02 | 6A - Switch - 1 Way - with Indicator - 1 Module | 352 | 1/20/200 |
| 6794 03 | 6A - Switch - 1 Way - with "Light" Marking - 1 Module | 274 | 1/20/200 |
| 6794 04 | 6A - Switch - 1 Way - with "Fan" Marking - 1 Module | 274 | 1/20/200 |

Switches - 10A - 230V AC

| | | | |
|---------|--|------|----------|
| 6794 05 | 10A - Switch - 1 Way - 2 Module | 412 | 1/10/100 |
| 6794 06 | 10A - Switch - 2 Way - 2 Module | 440 | 1/10/100 |
| 6794 07 | 10A - Intermediate Switch - 230V AC - 2 Module | 2558 | 1/10/100 |
| 6794 08 | 10A - Switch - 1 Way - with Indicator - 2 Module | 474 | 1/10/100 |

Myrius™

Charcoal Grey Mechanism

| Cat.Nos | Description | MRP* ₹ / Unit | Pack |
|---------|-------------|------------------|------|
|---------|-------------|------------------|------|

Switches - 16A - 230V AC

| | | | |
|---------|--|-----|----------|
| 6794 09 | 16A - Switch - 1 Way - 1 Module | 432 | 1/20/200 |
| 6794 10 | 16A - Switch - 2 Way - 1 Module | 526 | 1/20/200 |
| 6794 11 | 16A - Switch - 1 Way - with Indicator - 1 Module | 544 | 1/20/200 |

Switches - 20A - 230V AC

| | | | |
|---------|---|-----|----------|
| 6794 12 | 20A - Switch - 1 Way - 1 Module | 582 | 1/20/200 |
| 6794 13 | 20A - Switch - DP - 1 Way - 2 Module | 908 | 1/10/100 |
| 6794 14 | 20A - Switch - DP - 1 Way - with Indicator - 2 Module | 964 | 1/10/100 |
| 6794 15 | 20A - Switch - 2 Way - 2 Module | 992 | 1/10/100 |

Switches - 25A - 230V AC

| | | | |
|---------|---|-----|----------|
| 6794 16 | 25A - Switch - SP - 1 Way - with Indicator - 1 Module | 664 | 1/20/200 |
|---------|---|-----|----------|

Switches 32A 230V AC

| | | | |
|---------|---|------|----------|
| 6794 17 | 32A - Switch - DP - with Indicator - 2 Module | 1480 | 1/10/100 |
|---------|---|------|----------|

Push Button 6A 230V AC

| | | | |
|---------|--|-----|----------|
| 6794 18 | 6A - Push Button - SP - 1 Way - 1 Module | 386 | 1/20/200 |
| 6794 19 | 6A - Push Button - 1 Way - with Indicator - 1 Module | 482 | 1/20/200 |
| 6794 20 | 6A - Bell Push - 1 Way - 1 Module | 360 | 1/20/200 |
| 6794 21 | 6A - Bell Push - 1 Way - with Indicator - 1 Module | 482 | 1/20/200 |
| 6794 22 | 6A - Bell Push - 1 Way - 2 Module | 556 | 1/10/100 |
| 6794 23 | 6A - Bell Push - 1 Way - with Indicator - 2 Module | 664 | 1/10/100 |

Indian Standard Socket

| | | | |
|---------|---|------|----------|
| 6794 35 | 6A - Socket - with Shutter - 3 Pin - ISI - 2 Module | 318 | 1/20/200 |
| 6794 30 | 6/16A - Socket - with Shutter - ISI - 2 Module | 696 | 1/10/100 |
| 6794 29 | 6/16A - Socket - with Shutter - ISI - 3 Module | 822 | 1/5/50 |
| 6794 26 | 16A - Switched Socket - with Shutter - 3 Pin - 3 Module | 1752 | 1/5/50 |

* MRP - Maximum Retail Price Inclusive of all taxes including GST.

Bold Cat.Nos are products normally available with Legrand (India) Stockists. Cat.Nos that are not bold - delivery within 4 - 8 weeks from the date of order. Bold packing quantity is our mandatory packing. Orders to be placed by Legrand (India) Stockist in multiples of the same.

Myrius™ Charcoal Grey Mechanism

| Cat.Nos | Description | MRP ₹ / Unit | Pack |
|---------|-------------|--------------------|------|
|---------|-------------|--------------------|------|

Dimmers & Fan Regulators

| | | | |
|---------|--|------|----------|
| 6794 36 | Rotary Dimmer - 400 Watts - 1 Module | 1720 | 5/50 |
| 6794 37 | Rotary Light Dimmer - 500 Watts - 2 Module | 2612 | 10/100 |
| 6794 39 | Fan Regulator - 100 Watts - ISI - 1 Module | 1344 | 5/50 |
| 6794 40 | Fan Regulator - 100 Watts - 360° - ISI - 2 Module | 1522 | 10/100 |
| 6794 41 | Fan Regulator - 120 Watts - 360° - ISI - 2 Module | 1678 | 10/100 |
| 6794 42 | Fan Regulator - 70 Watts - ISI - 2 Module | 1620 | 1/10/100 |
| 6794 31 | Fan Regulator - 8 Steps - 100 Watts - ISI - 2 Module | 1392 | 10/100 |
| 6794 96 | Fan Regulator - BLDC - 2 Module ^A | 1646 | 10/100 |

Skirting Light

| | | | |
|---------|---|------|--------|
| 6794 48 | Skirting Light - with Warm White LED - 3 Module | 1296 | 1/5/25 |
|---------|---|------|--------|

Bell Call Indicator

| | | | |
|---------|--------------------------------|------|----------|
| 6794 49 | Bell Call Indicator - 1 Module | 1736 | 1/20/200 |
|---------|--------------------------------|------|----------|

Buzzer

| | | | |
|---------|--------------------------|------|----------|
| 6794 50 | Buzzer - 230V - 1 Module | 1582 | 1/20/200 |
|---------|--------------------------|------|----------|

Remote Unit

| | | | |
|---------|--|-------|--------|
| 6794 52 | Remote Control Unit - for Light & Fan - 4 Module | 10332 | 1/5/20 |
| 6793 03 | Remote Control Hand Unit | 794 | 1/5/30 |

Hospitality Function Hotel Keycard Switch

| | | | |
|---------|----------------------------------|------|----------|
| 6794 53 | 16A - Key Card Switch - 2 Module | 6200 | 1/10 |
| 6792 55 | Key Fob for Key Card Switch | 234 | 1/10/100 |

Hotel "DND and MMR" Functions

| | | | |
|---------|---|------|----------|
| 6794 54 | External DND & MMR Control Unit - with Bell Push - 2 Module | 2636 | 1/10/100 |
| 6794 55 | Internal DND & MMR Control Unit - 2 Module | 1738 | 1/10/100 |

Shaver Socket

| | | | |
|---------|---|------|--------|
| 6794 58 | Shaver Socket - 120/240V AC - Monoblock with Plate - 2 Module | 4568 | 1/16 |
| 6794 59 | Shaver Socket - 120/230V AC - Monoblock with Plate - 4 Module | 7248 | 1/5/20 |

Sockets & Connectors

Tv Sockets

| | | | |
|---------|---------------------------------|-----|----------|
| 6794 60 | TV Co - axial Socket - 1 Module | 362 | 1/20/200 |
|---------|---------------------------------|-----|----------|

Myrius™ Charcoal Grey Mechanism

| Cat.Nos | Description | MRP ₹ / Unit | Pack |
|---------|-------------|--------------------|------|
|---------|-------------|--------------------|------|

Data & Voice

| | | | |
|---------|---|------|----------|
| 6794 62 | Telephone Socket - RJ11 - 1 Module | 348 | 1/20/200 |
| 6794 63 | Telephone Socket - Double RJ11 - 1 Module | 534 | 1/20/200 |
| 6794 64 | Information Socket - RJ45 - Cat 5E - UTP - Toolless with Shutter - 1 Module | 706 | 1/20/200 |
| 6794 65 | Information Socket - RJ45 - Cat 6 - UTP - Toolless with Shutter - 1 Module | 1042 | 1/20/200 |
| 6794 66 | Information Socket - RJ45 - Cat 6 - UTP - Toolless with Shutter - 2 Module | 1069 | 1/10/100 |
| 6797 14 | Information Socket - RJ45 - Cat 6A - STP - 1 Module | 1214 | 20/200 |

Audio & Video Connectors

| | | | |
|---------|--|------|------|
| 6794 67 | Preterminated Audio/Video Connector - 1 Module | 2756 | 1/10 |
| 6794 68 | Preterminated HDMI Socket - 1 Module | 3376 | 1/10 |
| 6794 69 | Preterminated Projector Connector - 1 Module | 3376 | 1/10 |

Sound (Volume Controller)

| | | | |
|---------|------------------------------|------|----------|
| 6794 70 | Volume Controller - 2 Module | 2083 | 1/10/100 |
|---------|------------------------------|------|----------|

Protectors & Accessories Motor Starter

| | | | |
|---------|--------------------------------|------|----------|
| 6794 71 | 16A - Motor Starter - 2 Module | 1098 | 1/10/100 |
| 6794 72 | 25A - Motor Starter - 2 Module | 1122 | 1/10/100 |

Electronic Function

USB Chargers (IS13252 (Part 1) / IEC 60950-1)

| | | | |
|----------------|---|-------|----------|
| 6794 88 | USB Charger - 1500mA - Type A - 1 Module | 2358 | 1/5/100 |
| 6794 89 | USB Charger - 3000mA - Type A + C - 2 Module | 3654 | 1/10/100 |
| 6798 51 | USB Charger - 3000mA/15 Watts - Type A - 1 Module | 2720 | 1/5/50 |
| 6798 52 | USB Charger - 3000mA/15 Watts - Type A + A - 1 Module | 3002 | 1/5/50 |
| 6798 53 | USB Charger - 3000mA/15 Watts - Type A + C - 1 Module | 3826 | 1/5/50 |
| 6798 54 | USB Charger - 3000mA/15 Watts - Type C + C - 1 Module | 4054 | 1/5/50 |
| 6798 55 | USB Charger - Power Delivery - 20 Watts - Type C - 1 Module | 5002 | 1/5/50 |
| 6792 74 | USB Charger - Power Delivery - 30 Watts - Type C + C - 2 Module | 7272 | 1/3/30 |
| 6798 57 | USB Charger - Power Delivery - 45 Watts - Type C - 2 Module | 9442 | 1/3/30 |
| 6798 59 | USB Charger - Power Delivery - 65 Watts - Type C + C - 3 Module | 11614 | 1/5/20 |

* MRP - Maximum Retail Price Inclusive of all taxes including GST.

^A Compatible with Atomberg (Efficio), Havells (Efficiencia neo), Orient (Aerostorm) as per 2023 fan models.

Red Cat. Nos - New Products

Bold Cat.Nos are products normally available with Legrand (India) Stockists. Cat.Nos that are not bold - delivery within 4 - 8 weeks from the date of order. Bold packing quantity is our mandatory packing. Orders to be placed by Legrand (India) Stockist in multiples of the same.

Myrius™

Classic White Anti Bacterial Mechanism

| Cat.Nos | Description | MRP ₹ / Unit | Pack |
|---------|-------------|--------------------|------|
|---------|-------------|--------------------|------|

Sound Receiver

| | | | |
|---------|--------------------------------------|------|----------|
| 6794 97 | Bluetooth Sound Diffusion - 2 Module | 8854 | 1/10/100 |
|---------|--------------------------------------|------|----------|

Rotary Dimmer Universal

| | | | |
|---------|---|------|----------|
| 6794 98 | Rotary LED Light Dimmer - 50 Watts - 1 Module | 3544 | 1/10/120 |
|---------|---|------|----------|

Accessories

| | | | |
|---------|-------------------------------|-----|----------|
| 6794 75 | Cable Outlet - 8mm - 1 Module | 392 | 1/20/200 |
|---------|-------------------------------|-----|----------|

| | | | |
|---------|---------------------------|----|----------|
| 6794 76 | Blanking Plate - 1 Module | 68 | 1/40/400 |
|---------|---------------------------|----|----------|

Classic White - Anti Bacterial Mechanism Switches - 6A - 230V AC

| | | | |
|---------|---|-----|----------|
| 6793 20 | 6A - Switch - 1 Way - 1 Module - Anti - Bacterial | 232 | 1/20/200 |
|---------|---|-----|----------|

| | | | |
|---------|---|-----|----------|
| 6793 21 | 6A - Switch - 2 Way - 1 Module - Anti - Bacterial | 342 | 1/20/200 |
|---------|---|-----|----------|

| | | | |
|---------|--|-----|----------|
| 6793 24 | 6A - Bell Push - 1 Module - Anti - Bacterial | 398 | 1/20/200 |
|---------|--|-----|----------|

Switches - 16A - 230V AC

| | | | |
|---------|--|-----|----------|
| 6793 22 | 16A - Switch - 1 Way - 1 Module - Anti - Bacterial | 468 | 1/20/200 |
|---------|--|-----|----------|

| | | | |
|---------|--|-----|----------|
| 6793 23 | 16A - Switch - 2 Way - 1 Module - Anti - Bacterial | 544 | 1/20/200 |
|---------|--|-----|----------|

Indian Standard Socket

| | | | |
|---------|--|-----|----------|
| 6792 38 | 6A - Socket - with Shutter - 3 Pin - ISI - 2 Module - Anti - Bacterial | 348 | 1/20/200 |
|---------|--|-----|----------|

| | | | |
|---------|---|-----|----------|
| 6793 28 | 6/16A - Socket - with Shutter - ISI - 2 Module - Anti - Bacterial | 812 | 1/10/100 |
|---------|---|-----|----------|

| | | | |
|---------|---|-----|--------|
| 6793 29 | 6/16A - Socket - with Shutter - ISI - 3 Module - Anti - Bacterial | 874 | 1/5/50 |
|---------|---|-----|--------|

Fan Regulators

| | | | |
|---------|--|------|--------|
| 6793 25 | Fan Regulator - 120 Watts - 360° - ISI - 2 Module - Anti - Bacterial | 1776 | 10/100 |
|---------|--|------|--------|

TV Sockets

| | | | |
|---------|--|-----|----------|
| 6793 30 | TV Co - axial Socket - 1 Module - Anti - Bacterial | 362 | 1/20/200 |
|---------|--|-----|----------|

Data & Voice

| | | | |
|---------|---|-----|----------|
| 6793 31 | Telephone Socket - RJ11 - 1 Module - Anti - Bacterial | 362 | 1/20/200 |
|---------|---|-----|----------|

| | | | |
|---------|---|------|----------|
| 6793 32 | Information Socket - RJ45 - Cat 6 - UTP - 1 Module - Anti - Bacterial | 1104 | 1/20/200 |
|---------|---|------|----------|

Accessories

| | | | |
|---------|--|----|----------|
| 6793 33 | Blanking Plate - 1 Module - Anti - Bacterial | 62 | 1/40/400 |
|---------|--|----|----------|

Myrius™

Cover Plates

| Cat.Nos | Description | MRP ₹ / Unit | Pack |
|---------|-------------|--------------------|------|
|---------|-------------|--------------------|------|

Cover Plates with Support Frame

Classic White Cover Plates with Support Frame

| | | | |
|---------|--|-----|--------|
| 6795 01 | Cover Plate - 1 Module - Classic White | 248 | 20/200 |
|---------|--|-----|--------|

| | | | |
|---------|--|-----|--------|
| 6795 02 | Cover Plate - 2 Module - Classic White | 258 | 20/200 |
|---------|--|-----|--------|

| | | | |
|---------|--|-----|--------|
| 6795 03 | Cover Plate - 3 Module - Classic White | 272 | 10/100 |
|---------|--|-----|--------|

| | | | |
|---------|--|-----|--------|
| 6795 04 | Cover Plate - 4 Module - Classic White | 304 | 10/100 |
|---------|--|-----|--------|

| | | | |
|---------|--|-----|------|
| 6795 06 | Cover Plate - 6 Module - Classic White | 526 | 5/50 |
|---------|--|-----|------|

| | | | |
|---------|--|-----|------|
| 6795 08 | Cover Plate - 8 Module - Classic White | 576 | 5/50 |
|---------|--|-----|------|

| | | | |
|---------|--|-----|------|
| 6795 09 | Cover Plate - 2*4 Module - Classic White | 732 | 5/25 |
|---------|--|-----|------|

| | | | |
|---------|--|-----|------|
| 6795 10 | Cover Plate - 9 Module - Classic White | 774 | 5/50 |
|---------|--|-----|------|

| | | | |
|---------|---|-----|------|
| 6795 12 | Cover Plate - 12 Module - Classic White | 878 | 1/10 |
|---------|---|-----|------|

| | | | |
|---------|---|------|------|
| 6795 16 | Cover Plate - 16 Module - Classic White | 1022 | 1/10 |
|---------|---|------|------|

| | | | |
|---------|--|------|------|
| 6795 17 | Cover Plate - 16 Module(Big) - Classic White | 1108 | 1/10 |
|---------|--|------|------|

| | | | |
|---------|---|------|------|
| 6795 18 | Cover Plate - 18 Module - Classic White | 1172 | 1/10 |
|---------|---|------|------|

Charcoal Grey Cover Plates with Support Frame

| | | | |
|---------|--|-----|--------|
| 6797 01 | Cover Plate - 1 Module - Charcoal Grey | 300 | 20/200 |
|---------|--|-----|--------|

| | | | |
|---------|--|-----|--------|
| 6797 02 | Cover Plate - 2 Module - Charcoal Grey | 314 | 20/200 |
|---------|--|-----|--------|

| | | | |
|---------|--|-----|--------|
| 6797 03 | Cover Plate - 3 Module - Charcoal Grey | 340 | 10/100 |
|---------|--|-----|--------|

| | | | |
|---------|--|-----|--------|
| 6797 04 | Cover Plate - 4 Module - Charcoal Grey | 364 | 10/100 |
|---------|--|-----|--------|

| | | | |
|---------|--|-----|------|
| 6797 06 | Cover Plate - 6 Module - Charcoal Grey | 650 | 5/50 |
|---------|--|-----|------|

| | | | |
|---------|--|-----|------|
| 6797 08 | Cover Plate - 8 Module - Charcoal Grey | 708 | 5/50 |
|---------|--|-----|------|

| | | | |
|---------|--|-----|------|
| 6797 09 | Cover Plate - 2*4 Module - Charcoal Grey | 900 | 5/25 |
|---------|--|-----|------|

| | | | |
|---------|--|-----|------|
| 6797 10 | Cover Plate - 9 Module - Charcoal Grey | 966 | 5/50 |
|---------|--|-----|------|

| | | | |
|---------|---|------|------|
| 6797 12 | Cover Plate - 12 Module - Charcoal Grey | 1082 | 1/10 |
|---------|---|------|------|

| | | | |
|---------|---|------|------|
| 6797 16 | Cover Plate - 16 Module - Charcoal Grey | 1252 | 1/10 |
|---------|---|------|------|

| | | | |
|---------|--|------|------|
| 6797 17 | Cover Plate - 16 Module(Big) - Charcoal Grey | 1348 | 1/10 |
|---------|--|------|------|

| | | | |
|---------|---|------|------|
| 6797 18 | Cover Plate - 18 Module - Charcoal Grey | 1440 | 1/10 |
|---------|---|------|------|

Ice White Cover Plates with Support Frame

| | | | |
|---------|------------------------------------|-----|--------|
| 6795 21 | Cover Plate - 1 Module - Ice White | 352 | 1/5/30 |
|---------|------------------------------------|-----|--------|

| | | | |
|---------|------------------------------------|-----|--------|
| 6795 22 | Cover Plate - 2 Module - Ice White | 372 | 1/5/30 |
|---------|------------------------------------|-----|--------|

| | | | |
|---------|------------------------------------|-----|------|
| 6795 23 | Cover Plate - 3 Module - Ice White | 396 | 1/20 |
|---------|------------------------------------|-----|------|

| | | | |
|---------|------------------------------------|-----|------|
| 6795 24 | Cover Plate - 4 Module - Ice White | 422 | 1/20 |
|---------|------------------------------------|-----|------|

| | | | |
|---------|------------------------------------|-----|------|
| 6795 26 | Cover Plate - 6 Module - Ice White | 766 | 1/10 |
|---------|------------------------------------|-----|------|

| | | | |
|---------|------------------------------------|-----|------|
| 6795 28 | Cover Plate - 8 Module - Ice White | 834 | 1/10 |
|---------|------------------------------------|-----|------|

| | | | |
|---------|--------------------------------------|------|-----|
| 6795 29 | Cover Plate - 2*4 Module - Ice White | 1044 | 1/5 |
|---------|--------------------------------------|------|-----|

* MRP - Maximum Retail Price Inclusive of all taxes including GST.

Bold Cat.Nos are products normally available with Legrand (India) Stockists. Cat.Nos that are not bold - delivery within 4 - 8 weeks from the date of order. Bold packing quantity is our mandatory packing. Orders to be placed by Legrand (India) Stockist in multiples of the same.

Myrius™

Cover Plates

| Cat.Nos | Description | MRP ₹ / Unit | Pack |
|---------|--|--------------------|------|
| 6795 32 | Cover Plate - 12 Module - Ice White | 1270 | 1/5 |
| 6795 36 | Cover Plate - 16 Module - Ice White | 1478 | 1/5 |
| 6795 37 | Cover Plate - 16 Module(Big) - Ice White | 1566 | 1/5 |
| 6795 38 | Cover Plate - 18 Module - Ice White | 1694 | 1/5 |

Ice Black Cover Plates with Support Frame

| | | | |
|---------|--|------|--------|
| 6795 41 | Cover Plate - 1 Module - Ice Black | 352 | 1/5/30 |
| 6795 42 | Cover Plate - 2 Module - Ice Black | 372 | 1/5/30 |
| 6795 43 | Cover Plate - 3 Module - Ice Black | 396 | 1/20 |
| 6795 44 | Cover Plate - 4 Module - Ice Black | 422 | 1/20 |
| 6795 46 | Cover Plate - 6 Module - Ice Black | 766 | 1/10 |
| 6795 48 | Cover Plate - 8 Module - Ice Black | 834 | 1/10 |
| 6795 49 | Cover Plate - 2*4 Module - Ice Black | 1044 | 1/5 |
| 6795 52 | Cover Plate - 12 Module - Ice Black | 1270 | 1/5 |
| 6795 56 | Cover Plate - 16 Module - Ice Black | 1478 | 1/5 |
| 6795 57 | Cover Plate - 16 Module(Big) - Ice Black | 1566 | 1/5 |
| 6795 58 | Cover Plate - 18 Module - Ice Black | 1694 | 1/5 |

Pearl Champagne Cover Plates with Support Frame

| | | | |
|---------|---|------|--------|
| 6795 61 | Cover Plate - 1 Module - Pearl Champagne | 480 | 1/5/30 |
| 6795 62 | Cover Plate - 2 Module - Pearl Champagne | 508 | 1/5/30 |
| 6795 63 | Cover Plate - 3 Module - Pearl Champagne | 540 | 1/20 |
| 6795 64 | Cover Plate - 4 Module - Pearl Champagne | 584 | 1/20 |
| 6795 66 | Cover Plate - 6 Module - Pearl Champagne | 1044 | 1/10 |
| 6795 68 | Cover Plate - 8 Module - Horizontal - Pearl Champagne | 1140 | 1/10 |
| 6795 69 | Cover Plate - 2*4 Module - Vertical - Pearl Champagne | 1428 | 1/5 |
| 6795 72 | Cover Plate - 12 Module - Pearl Champagne | 1728 | 1/5 |
| 6795 76 | Cover Plate - 16 Module - Pearl Champagne | 2010 | 1/5 |
| 6795 77 | Cover Plate - 16 Module(Big) - Pearl Champagne | 2134 | 1/5 |
| 6795 78 | Cover Plate - 18 Module - Pearl Champagne | 2314 | 1/5 |

Sonic Silver Cover Plates with Support Frame

| | | | |
|---------|---------------------------------------|-----|--------|
| 6795 81 | Cover Plate - 1 Module - Sonic Silver | 480 | 1/5/30 |
| 6795 82 | Cover Plate - 2 Module - Sonic Silver | 508 | 1/5/30 |

Myrius™

Cover Plates

| Cat.Nos | Description | MRP ₹ / Unit | Pack |
|---------|--|--------------------|------|
| 6795 83 | Cover Plate - 3 Module - Sonic Silver | 540 | 1/20 |
| 6795 84 | Cover Plate - 4 Module - Sonic Silver | 584 | 1/20 |
| 6795 86 | Cover Plate - 6 Module - Sonic Silver | 1044 | 1/10 |
| 6795 88 | Cover Plate - 8 Module - Horizontal - Sonic Silver | 1140 | 1/10 |
| 6795 89 | Cover Plate - 2*4 Module - Vertical - Sonic Silver | 1428 | 1/5 |
| 6795 92 | Cover Plate - 12 Module - Sonic Silver | 1728 | 1/5 |
| 6795 96 | Cover Plate - 16 Module - Sonic Silver | 2010 | 1/5 |
| 6795 97 | Cover Plate - 16 Module(Big) - Sonic Silver | 2134 | 1/5 |
| 679598 | Cover Plate - 18 Module - Sonic Silver | 2314 | 1/5 |

Dark Fade Cover Plates with Support Frame

| | | | |
|---------|---|------|--------|
| 6796 01 | Cover Plate - 1 Module - Dark Fade | 480 | 1/5/30 |
| 6796 02 | Cover Plate - 2 Module - Dark Fade | 508 | 1/5/30 |
| 6796 03 | Cover Plate - 3 Module - Dark Fade | 540 | 1/20 |
| 6796 04 | Cover Plate - 4 Module - Dark Fade | 584 | 1/20 |
| 6796 06 | Cover Plate - 6 Module - Dark Fade | 1044 | 1/10 |
| 6796 08 | Cover Plate - 8 Module - Horizontal - Dark Fade | 1140 | 1/10 |
| 6796 09 | Cover Plate - 2*4 Module - Vertical - Dark Fade | 1428 | 1/5 |
| 6796 12 | Cover Plate - 12 Module - Dark Fade | 1728 | 1/5 |
| 6796 16 | Cover Plate - 16 Module - Dark Fade | 2010 | 1/5 |
| 6796 17 | Cover Plate - 16 Module(Big) - Dark Fade | 2134 | 1/5 |
| 6796 18 | Cover Plate - 18 Module - Dark Fade | 2314 | 1/5 |

Ice Graphite Cover Plates with Support Frame

| | | | |
|---------|--|------|--------|
| 6797 21 | Cover Plate - 1 Module - Ice Graphite | 352 | 1/5/30 |
| 6797 22 | Cover Plate - 2 Module - Ice Graphite | 372 | 1/5/30 |
| 6797 23 | Cover Plate - 3 Module - Ice Graphite | 396 | 1/20 |
| 6797 24 | Cover Plate - 4 Module - Ice Graphite | 422 | 1/20 |
| 6797 26 | Cover Plate - 6 Module - Ice Graphite | 766 | 1/10 |
| 6797 28 | Cover Plate - 8 Module - Horizontal - Ice Graphite | 834 | 1/10 |
| 6797 29 | Cover Plate - 2*4 Module - Vertical - Ice Graphite | 1046 | 1/5 |
| 6797 32 | Cover Plate - 12 Module - Ice Graphite | 1264 | 1/5 |
| 6797 36 | Cover Plate - 16 Module - Ice Graphite | 1476 | 1/5 |
| 6797 37 | Cover Plate - 16 Module(Big) - Ice Graphite | 1566 | 1/5 |
| 6797 38 | Cover Plate - 18 Module - Ice Graphite | 1694 | 1/5 |

* MRP - Maximum Retail Price Inclusive of all taxes including GST.

Bold Cat.Nos are products normally available with Legrand (India) Stockists. Cat.Nos that are not bold - delivery within 4 - 8 weeks from the date of order. Bold packing quantity is our mandatory packing. Orders to be placed by Legrand (India) Stockist in multiples of the same.

Myrius™

Cover Plates

| Cat.Nos | Description | MRP ₹ / Unit | Pack |
|---------|-------------|--------------------|------|
|---------|-------------|--------------------|------|

Ice Silk Cover Plates with Support Frame

| | | | |
|---------|--|------|--------|
| 6797 41 | Cover Plate - 1 Module - Ice Silk | 352 | 1/5/30 |
| 6797 42 | Cover Plate - 2 Module - Ice Silk | 372 | 1/5/30 |
| 6797 43 | Cover Plate - 3 Module - Ice Silk | 396 | 1/20 |
| 6797 44 | Cover Plate - 4 Module - Ice Silk | 422 | 1/20 |
| 6797 46 | Cover Plate - 6 Module - Ice Silk | 766 | 1/10 |
| 6797 48 | Cover Plate - 8 Module - Horizontal - Ice Silk | 834 | 1/10 |
| 6797 49 | Cover Plate - 2*4 Module - Vertical - Ice Silk | 1046 | 1/5 |
| 6797 62 | Cover Plate - 12 Module - Ice Silk | 1264 | 1/5 |
| 6797 56 | Cover Plate - 16 Module - Ice Silk | 1476 | 1/5 |
| 6797 67 | Cover Plate Big - 16 Module(Big) - Ice Silk | 1566 | 1/5 |
| 6797 68 | Cover Plate - 18 Module - Ice Silk | 1694 | 1/5 |

White Glass Cover Plates with Support Frame

| | | | |
|---------|---|------|--------|
| 6798 11 | Cover Plate - 1 Module - White Glass | 1274 | 1/5/30 |
| 6798 12 | Cover Plate - 2 Module - White Glass | 1296 | 1/5/30 |
| 6798 13 | Cover Plate - 3 Module - White Glass | 1370 | 1/20 |
| 6798 14 | Cover Plate - 4 Module - White Glass | 1542 | 1/20 |
| 6798 16 | Cover Plate - 6 Module - White Glass | 1686 | 1/10 |
| 6798 18 | Cover Plate - 8 Module - Horizontal - White Glass | 1826 | 1/10 |
| 6798 19 | Cover Plate - 2*4 Module - Vertical - White Glass | 2232 | 1/5 |
| 6798 22 | Cover Plate - 12 Module - White Glass | 2842 | 1/5 |
| 6798 26 | Cover Plate - 16 Module - White Glass | 5022 | 1/5 |
| 6798 28 | Cover Plate - 18 Module - White Glass | 6226 | 1/5 |

Black Glass Cover Plates with Support Frame

| | | | |
|---------|---|------|--------|
| 6798 31 | Cover Plate - 1 Module - Black Glass | 1274 | 1/5/30 |
| 6798 32 | Cover Plate - 2 Module - Black Glass | 1296 | 1/5/30 |
| 6798 33 | Cover Plate - 3 Module - Black Glass | 1370 | 1/20 |
| 6798 34 | Cover Plate - 4 Module - Black Glass | 1542 | 1/20 |
| 6798 36 | Cover Plate - 6 Module - Black Glass | 1686 | 1/10 |
| 6798 38 | Cover Plate - 8 Module - Horizontal - Black Glass | 1826 | 1/10 |

Myrius™

Cover Plates

| Cat.Nos | Description | MRP ₹ / Unit | Pack |
|---------|-------------|--------------------|------|
|---------|-------------|--------------------|------|

Black Glass Cover Plates with Support Frame

| | | | |
|---------|---|------|-----|
| 6798 39 | Cover Plate - 2*4 Module - Vertical - Black Glass | 2232 | 1/5 |
| 6798 42 | Cover Plate - 12 Module - Black Glass | 2842 | 1/5 |
| 6798 46 | Cover Plate - 16 Module - Black Glass | 5022 | 1/5 |
| 6798 48 | Cover Plate - 18 Module - Black Glass | 6226 | 1/5 |

Anti-Bacterial Cover Plates with Support Frame

| | | | |
|---------|--|------|--------|
| 6793 41 | Cover Plate - 1 Module - Anti-Bacterial-Classic White | 278 | 20/200 |
| 6793 42 | Cover Plate - 2 Module - Anti-Bacterial-Classic White | 306 | 20/200 |
| 6793 43 | Cover Plate - 3 Module - Anti-Bacterial-Classic White | 344 | 10/100 |
| 6793 44 | Cover Plate - 4 Module - Anti-Bacterial-Classic White | 366 | 10/100 |
| 6793 46 | Cover Plate - 6 Module - Anti-Bacterial-Classic White | 600 | 5/50 |
| 6793 48 | Cover Plate - 8 Module - Horizontal - Anti-Bacterial-Classic White | 704 | 5/50 |
| 6793 49 | Cover Plate - 2*4 Module - Vertical - Anti-Bacterial-Classic White | 880 | 5/25 |
| 6793 50 | Cover Plate - 9 Module - Anti-Bacterial-Classic White | 912 | 5/50 |
| 6793 52 | Cover Plate - 12 Module - Anti-Bacterial-Classic White | 1010 | 10 |
| 6793 56 | Cover Plate - 16 Module - Anti-Bacterial-Classic White | 1196 | 10 |
| 6793 58 | Cover Plate - 18 Module - Anti-Bacterial-Classic White | 1334 | 10 |

Metal Flush Boxes

| | | | |
|---------|--------------------------------|-----|----|
| 6890 07 | Metal Flush Box - 1/2 Module | 170 | 40 |
| 6890 08 | Metal Flush Box - 3 Module | 170 | 40 |
| 6890 09 | Metal Flush Box - 4 Module | 226 | 40 |
| 6890 10 | Metal Flush Box - 6 Module | 358 | 40 |
| 6890 42 | Metal Flush Box - 8 Module | 416 | 40 |
| 6890 31 | Metal Flush Box - 2*4 Module | 414 | 20 |
| 6890 29 | Metal Flush Box - 9 Module | 490 | 20 |
| 6890 11 | Metal Flush Box - 12/16 Module | 624 | 10 |
| 6890 12 | Metal Flush Box - 18/24 Module | 788 | 10 |

* MRP - Maximum Retail Price Inclusive of all taxes including GST.

Bold Cat.Nos are products normally available with Legrand (India) Stockists. Cat.Nos that are not bold - delivery within 4 - 8 weeks from the date of order. Bold packing quantity is our mandatory packing. Orders to be placed by Legrand (India) Stockist in multiples of the same.

Myrius™ Mounting Boxes

| Cat.Nos | Description | MRP ₹ / Unit | Pack |
|---------|-------------|--------------------|------|
|---------|-------------|--------------------|------|

Plastic Surface Boxes

| | | | |
|---------|----------------------------------|-----|-------|
| 6733 02 | Plastic Surface Box - 1/2 Module | 100 | 10/50 |
| 6733 03 | Plastic Surface Box - 3 Module | 114 | 5/35 |
| 6733 04 | Plastic Surface Box - 4 Module | 134 | 5/25 |
| 6733 06 | Plastic Surface Box - 6 Module | 172 | 1/10 |
| 6733 08 | Plastic Surface Box - 8 Module | 254 | 1/5 |
| 6733 05 | Plastic Surface Box - 2*4 Module | 240 | 1/5 |

Metal Surface Boxes

| | | | |
|---------|--|-----|-----|
| 6890 21 | Metal Surface Box - 12 Module (2 Rows*6) | 600 | 1/6 |
| 6890 22 | Metal Surface Box - 18 Module (3 Rows*6) | 634 | 1/4 |

Myrius™

Guarantee

- The Company, at its discretion, will replace products if they have any manufacturing defect within 10 years for switches (without LED lamp) and power sockets. For all other **Myrius™** wiring accessories the guarantee will be 2 years.
- The above guarantee is applicable when the devices are used in Legrand metal flush boxes. Otherwise the guarantee period will be reduced by 50%.
- The guarantee is only applicable when the products are installed as per the Company's instructions and not tampered in any manner.
- The guarantee states the Company's entire liability. It does not extend to cover consequential loss or damage or installation costs arising from defective products.

Our switches are compliant with revised BIS standard (IS 3854:2023) requirements. Also, our switches are covered additionally for use on Self-Ballasted Lamp (SBL) loads.

SBL power rating as per IS3854:2023

| Switch Rating | 6A, 230V~ | 10A, 230V~ | 16A, 230V~ | 20A, 230V~ |
|------------------|-----------|------------|------------|------------|
| SBL power (Watt) | 100 W | 100 W | 200 W | 250 W |

* MRP - Maximum Retail Price Inclusive of all taxes including GST.

Bold Cat.Nos are products normally available with Legrand (India) Stockists. Cat.Nos that are not bold - delivery within 4 - 8 weeks from the date of order. Bold packing quantity is our mandatory packing. Orders to be placed by Legrand (India) Stockist in multiples of the same.

Myrius™ IoT

Smart Control for Connected Living



Myrius™ IoT introduces wireless automation for lighting, curtains, and power outlets, enabling convenient smart control through the **Home+Control** smartphone app. Designed for modern homes, it allows users to create scenes, monitor energy usage, and manage devices remotely.

Features

- Control up to four scenarios with our wireless 4-scenario control switch
- Switch dimmer with neutral (1M) for smooth lighting adjustment
- Wireless switches and in-wall wireless switch options
- App and voice compatibility for convenient device management

Benefits

- Simplifies everyday living with personalized automation scenes
- Enables convenient hands-free operation through voice commands
- Provides visibility of energy consumption for better management
- Upgrades homes with smart capabilities without additional wiring

Scan to know more about
the product.



Product Range



WIRELESS 4 SCENARIO CONTROL – 2M



Switch DIMMER WITH NEUTRAL – 1M



WIRELESS Switch 2G – 2M



IN WALL WIRELESS Switch – 1M



IN WALL MASTER HOME IN/AWAY – 1M



IN WALL MASTER WAKE UP/SLEEP – 1M



IN WALL WIRELESS SHUTTER Switch – 1M



16A Smart mobile plug



Home + Control App

Control with:

TOUCH | SWIPE | TALK

Myrius™ IoT Connected Homes White Mechanism

| Cat.Nos | Description | MRP* ₹ / Unit | Pack |
|---------|-------------|------------------|------|
|---------|-------------|------------------|------|

Connected Light Switches

| | | | |
|---------|--|-------|--------|
| 6793 59 | Connected Switch - with Neutral - Wired - 1 Module | 11084 | 1/5/50 |
| 6793 60 | Connected Switch - without Neutral - with Dimmer Option - Wired - 2 Module | 14446 | 1/5/50 |
| 6793 70 | Connected Switch Dimmer - with Neutral - 150 Watts - 1 Module | 8860 | 1/5/50 |
| 6793 71 | Connected Switch Dimmer - with Neutral - Wired - 2 Module | 14332 | 1/5/20 |

Connected Outlets

| | | | |
|---------|--|-------|--------|
| 6793 67 | 16A - Connected Socket Module - 1 Module | 11380 | 1/5/50 |
|---------|--|-------|--------|

Connected Curtain/Roller Blind Switches

| | | | |
|---------|--|-------|--------|
| 6793 61 | Connected Curtain/Roller Blind Switch - Wired - 1 Module | 11706 | 1/5/50 |
|---------|--|-------|--------|

Connected Step Fan Controller

| | | | |
|---------|---|------|--------|
| 6793 68 | Connected Step Fan Controller - with Neutral -100W - 2 Module | 8516 | 1/5/50 |
|---------|---|------|--------|

Connected Gateway Pack

| | | | |
|---------|---|-------|--------|
| 6793 66 | Connected Gateway + Master Home/Away Wireless Switch - Wired - 2 Module | 23674 | 1/5/20 |
|---------|---|-------|--------|

Wireless Control Switch

| | | | |
|---------|---|------|--------|
| 6793 62 | 1 Gang - Wireless Switch - 2 Module | 5212 | 1/5/30 |
| 6793 73 | 2 Gang - Wireless Switch - 2 Module | 5250 | 1/5/30 |
| 6793 64 | Curtain/Roller Blind Wireless Switch - 2 Module | 5878 | 1/5/30 |

Wireless Scenario Control Switch

| | | | |
|---------|---|------|--------|
| 6793 63 | Home/Away Wireless Master Switch - 2 Module | 5600 | 1/5/30 |
| 6793 65 | Wake Up/Sleep Wireless Scenario Control Switch - 2 Module | 6110 | 1/5/30 |
| 6793 69 | Wireless 4 Scenario Control Switch - 2 Module | 6658 | 1/5/30 |

In Wall Wireless Switch

| | | | |
|---------|--|------|--------|
| 6793 72 | In Wall Wireless Switch - 1 Module | 4560 | 1/5/20 |
| 6793 94 | In Wall Wireless Shutter Switch - 1 Module | 5256 | 1/5/20 |
| 6793 92 | In Wall Home/Away Wireless Switch - 1 Module | 5336 | 1/5/20 |
| 6793 96 | In Wall Wake Up/Sleep Wireless Switch - 1 Module | 5336 | 1/5/20 |

* MRP - Maximum Retail Price Inclusive of all taxes including GST.

Myrius™ IoT Connected Homes Charcoal Grey Mechanism

| Cat.Nos | Description | MRP* ₹ / Unit | Pack |
|---------|-------------|------------------|------|
|---------|-------------|------------------|------|

Connected Light Switches

| | | | |
|---------|--|-------|--------|
| 6793 74 | Connected Switch - with Neutral - Wired - 1 Module | 12750 | 1/5/50 |
| 6793 75 | Connected Switch - without Neutral - with Dimmer Option - Wired - 2 Module | 16616 | 1/5/50 |
| 6793 85 | Connected Switch Dimmer - with Neutral - 150 Watts - 1 Module | 10186 | 1/5/20 |
| 6793 86 | Connected Switch Dimmer - with Neutral - Wired - 2 Module | 16476 | 1/5/20 |

Connected Outlets

| | | | |
|---------|--|-------|--------|
| 6793 82 | 16A - Connected Socket Module - 1 Module | 13088 | 1/5/50 |
|---------|--|-------|--------|

Connected Curtain/Roller Blind Switches

| | | | |
|---------|--|-------|--------|
| 6793 76 | Connected Curtain/Roller Blind Switch - Wired - 1 Module | 13462 | 1/5/50 |
|---------|--|-------|--------|

Connected Step Fan Controller

| | | | |
|---------|---|------|--------|
| 6793 83 | Connected Step Fan Controller - with Neutral -100W - 2 Module | 9794 | 1/5/50 |
|---------|---|------|--------|

Connected Gateway Pack

| | | | |
|---------|--|-------|--------|
| 6793 81 | Connected Gateway + Home/Away Wireless Switch - Wired - 2 Module | 27220 | 1/5/20 |
|---------|--|-------|--------|

Wireless Control Switch

| | | | |
|---------|---|------|--------|
| 6793 77 | 1 Gang - Wireless Switch - 2 Module | 5996 | 1/5/30 |
| 6793 79 | 2 Gang - Wireless Switch - 2 Module | 6346 | 1/5/30 |
| 6793 88 | Curtain/Roller Blind Wireless Switch - 2 Module | 6032 | 1/5/30 |

Wireless Scenario Control Switch

| | | | |
|---------|---|------|--------|
| 6793 78 | Home/Away Wireless Master Switch - 2 Module | 6860 | 1/5/30 |
| 6793 80 | Wake Up/Sleep Wireless Scenario Control Switch - 2 Module | 7020 | 1/5/30 |
| 6793 84 | Wireless 4 Scenario Control Switch - 2 Module | 7658 | 1/5/30 |

In Wall Wireless Switch

| | | | |
|---------|--|------|--------|
| 6793 87 | In Wall Wireless Switch - 1 Module | 5242 | 1/5/20 |
| 6793 95 | In Wall Wireless Shutter Switch - 1 Module | 6042 | 1/5/20 |
| 6793 93 | In Wall Home/Away Wireless Switch - 1 Module | 6134 | 1/5/20 |
| 6793 97 | In Wall Wake Up/Sleep Wireless Switch - 1 Module | 6134 | 1/5/20 |

Bold Cat.Nos are products normally available with Legrand (India) Stockists. Cat.Nos that are not bold - delivery within 4 - 8 weeks from the date of order. Bold packing quantity is our mandatory packing. Orders to be placed by Legrand (India) Stockist in multiples of the same.

Myrius™ IoT Cover Plates

| Cat.Nos | Description | MRP ₹ / Unit | Pack |
|---------|-------------|--------------------|------|
|---------|-------------|--------------------|------|

Micro Module Switch

| | | | |
|---------|--|------|--------|
| 6793 89 | Connected Micro Module Switch - with Neutral - Black | 8130 | 1/5/50 |
|---------|--|------|--------|

Smart Plug

| | | | |
|---------|-------------------------|-------|------|
| 6793 90 | 6A - Smart Mobile Plug | 10348 | 5/20 |
| 6793 91 | 16A - Smart Mobile Plug | 11146 | 5/21 |



6793 91



6795 02



6795 04

Cover Plate with Support Frame - Classic White

| | | | |
|---------|--|------|--------|
| 6795 01 | Cover Plate + Support Frame - 1 Module - Classic White | 248 | 20/200 |
| 6795 02 | Cover Plate + Support Frame - 2 Module - Classic White | 258 | 20/200 |
| 6795 03 | Cover Plate + Support Frame - 3 Module - Classic White | 272 | 10/100 |
| 6795 04 | Cover Plate + Support Frame - 4 Module - Classic White | 304 | 10/100 |
| 6795 06 | Cover Plate + Support Frame - 6 Module - Classic White | 526 | 5/50 |
| 6795 08 | Cover Plate + Support Frame - 8 Module - Classic White | 576 | 5/50 |
| 6795 09 | Cover Plate + Support Frame - 2*4 Module - Classic White | 732 | 5/25 |
| 6795 10 | Cover Plate + Support Frame - 9 Module - Classic White | 774 | 5/50 |
| 6795 12 | Cover Plate + Support Frame - 12 Module - Classic White | 878 | 10 |
| 6795 16 | Cover Plate + Support Frame - 16 Module - Classic White | 1022 | 10 |
| 6795 17 | Cover Plate + Support Frame - 16 Module(Big) - Classic White | 1108 | 1/10 |
| 6795 18 | Cover Plate + Support Frame - 18 Module - Classic White | 1172 | 10 |

Cover Plate with Support Frame - Ice White

| | | | |
|---------|--|-----|--------|
| 6795 21 | Cover Plate + Support Frame - 1 Module - Ice White | 352 | 1/5/30 |
| 6795 22 | Cover Plate + Support Frame - 2 Module - Ice White | 372 | 1/5/30 |
| 6795 23 | Cover Plate + Support Frame - 3 Module - Ice White | 396 | 1/20 |
| 6795 24 | Cover Plate + Support Frame - 4 Module - Ice White | 422 | 1/20 |



6795 22



6795 23



6795 42



6795 44

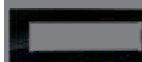

6795 48



6795 56

Myrius™ IoT Cover Plates

| Cat.Nos | Description | MRP ₹ / Unit | Pack |
|---------|-------------|--------------------|------|
|---------|-------------|--------------------|------|

Cover Plate with Support Frame - Ice White

| | | | |
|---------|--|------|------|
| 6795 26 | Cover Plate + Support Frame - 6 Module - Ice White | 766 | 1/10 |
| 6795 28 | Cover Plate + Support Frame - 8 Module - Ice White | 834 | 1/10 |
| 6795 29 | Cover Plate + Support Frame - 2*4 Module - Ice White | 1044 | 1/5 |
| 6795 32 | Cover Plate + Support Frame - 12 Module - Ice White | 1270 | 1/5 |
| 6795 36 | Cover Plate + Support Frame - 16 Module - Ice White | 1478 | 1/5 |
| 6795 37 | Cover Plate + Support Frame - 16 Module(Big) - Ice White | 1566 | 1/5 |
| 6795 38 | Cover Plate + Support Frame - 18 Module - Ice White | 1694 | 1/5 |

Cover Plate with Support Frame - Ice Black

| | | | |
|---------|--|------|--------|
| 6795 41 | Cover Plate + Support Frame - 1 Module - Ice Black | 352 | 1/5/30 |
| 6795 42 | Cover Plate + Support Frame - 2 Module - Ice Black | 372 | 1/5/30 |
| 6795 43 | Cover Plate + Support Frame - 3 Module - Ice Black | 396 | 1/20 |
| 6795 44 | Cover Plate + Support Frame - 4 Module - Ice Black | 422 | 1/20 |
| 6795 46 | Cover Plate + Support Frame - 6 Module - Ice Black | 766 | 1/10 |
| 6795 48 | Cover Plate + Support Frame - 8 Module - Ice Black | 834 | 1/10 |
| 6795 49 | Cover Plate + Support Frame - 2*4 Module - Ice Black | 1044 | 1/5 |
| 6795 52 | Cover Plate + Support Frame - 12 Module - Ice Black | 1270 | 1/5 |
| 6795 56 | Cover Plate + Support Frame - 16 Module - Ice Black | 1478 | 1/5 |
| 6795 57 | Cover Plate + Support Frame - 16 Module(Big) - Ice Black | 1566 | 1/5 |
| 6795 58 | Cover Plate + Support Frame - 18 Module - Ice Black | 1694 | 1/5 |

* MRP - Maximum Retail Price Inclusive of all taxes including GST.

Bold Cat.Nos are products normally available with Legrand (India) Stockists. Cat.Nos that are not bold - delivery within 4 - 8 weeks from the date of order. **Bold packing quantity** is our mandatory packing. Orders to be placed by Legrand (India) Stockist in multiples of the same.

Myrius™ IoT Cover Plates

| Cat.Nos | Description | MRP ₹ / Unit | Pack |
|---------|-------------|--------------------|------|
|---------|-------------|--------------------|------|

Cover Plate with Support Frame - Charcoal Grey

| | | | |
|---------|--|------|--------|
| 6797 01 | Cover Plate + Support Frame - 1 Module - Charcoal Grey | 300 | 20/200 |
| 6797 02 | Cover Plate + Support Frame - 2 Module - Charcoal Grey | 314 | 20/200 |
| 6797 03 | Cover Plate + Support Frame - 3 Module - Charcoal Grey | 340 | 10/100 |
| 6797 04 | Cover Plate + Support Frame - 4 Module - Charcoal Grey | 364 | 10/100 |
| 6797 06 | Cover Plate + Support Frame - 6 Module - Charcoal Grey | 650 | 5/50 |
| 6797 08 | Cover Plate + Support Frame - 8 Module - Charcoal Grey | 708 | 5/50 |
| 6797 09 | Cover Plate + Support Frame - 2*4 Module - Charcoal Grey | 900 | 5/25 |
| 6797 10 | Cover Plate + Support Frame - 9 Module - Charcoal Grey | 966 | 5/50 |
| 6797 12 | Cover Plate + Support Frame - 12 Module - Charcoal Grey | 1082 | 1/10 |
| 6797 16 | Cover Plate + Support Frame - 16 Module - Charcoal Grey | 1252 | 1/10 |
| 6797 17 | Cover Plate + Support Frame - 16 Module(Big) - Charcoal Grey | 1348 | 1/10 |
| 6797 18 | Cover Plate + Support Frame - 18 Module - Charcoal Grey | 1440 | 1/10 |

Cover Plate with Support Frame - Pearl Champagne

| | | | |
|---------|---|------|--------|
| 6795 61 | Cover Plate + Support Frame - 1 Module - Pearl Champagne | 480 | 1/5/30 |
| 6795 62 | Cover Plate + Support Frame - 2 Module - Pearl Champagne | 508 | 1/5/30 |
| 6795 63 | Cover Plate + Support Frame - 3 Module - Pearl Champagne | 540 | 1/20 |
| 6795 64 | Cover Plate + Support Frame - 4 Module - Pearl Champagne | 584 | 1/20 |
| 6795 66 | Cover Plate + Support Frame - 6 Module - Pearl Champagne | 1044 | 1/10 |
| 6795 68 | Cover Plate + Support Frame - 8 Module - Horizontal - Pearl Champagne | 1140 | 1/10 |

* MRP - Maximum Retail Price Inclusive of all taxes including GST.

Myrius™ IoT Cover Plates

| Cat.Nos | Description | MRP ₹ / Unit | Pack |
|---------|-------------|--------------------|------|
|---------|-------------|--------------------|------|

Cover Plate with Support Frame - Pearl Champagne

| | | | |
|----------|---|------|-----|
| 6795 69 | Cover Plate + Support Frame - 2*4 Module - Vertical - Pearl Champagne | 1428 | 1/5 |
| 6795 72 | Cover Plate + Support Frame - 12 Module - Pearl Champagne | 1728 | 1/5 |
| 6795 76 | Cover Plate + Support Frame - 16 Module - Pearl Champagne | 2010 | 1/5 |
| *6795 77 | Cover Plate + Support Frame - 16 Module(Big) - Pearl Champagne | 2134 | 1/5 |
| 6795 78 | Cover Plate + Support Frame - 18 Module - Pearl Champagne | 2314 | 1/5 |

Cover Plate with Support Frame - Sonic Silver

| | | | |
|----------|--|------|--------|
| 6795 81 | Cover Plate + Support Frame - 1 Module - Sonic Silver | 480 | 1/5/30 |
| 6795 82 | Cover Plate + Support Frame - 2 Module - Sonic Silver | 508 | 1/5/30 |
| 6795 83 | Cover Plate + Support Frame - 3 Module - Sonic Silver | 540 | 1/20 |
| 6795 84 | Cover Plate + Support Frame - 4 Module - Sonic Silver | 584 | 1/20 |
| 6795 86 | Cover Plate + Support Frame - 6 Module - Sonic Silver | 1044 | 1/10 |
| 6795 88 | Cover Plate + Support Frame - 8 Module - Horizontal - Sonic Silver | 1140 | 1/10 |
| 6795 89 | Cover Plate + Support Frame - 2*4 Module - Vertical - Sonic Silver | 1428 | 1/5 |
| 6795 92 | Cover Plate + Support Frame - 12 Module - Sonic Silver | 1728 | 1/5 |
| 6795 96 | Cover Plate + Support Frame - 16 Module - Sonic Silver | 2010 | 1/5 |
| *6795 97 | Cover Plate + Support Frame - 16 Module(Big) - Sonic Silver | 2134 | 1/5 |
| 6795 98 | Cover Plate + Support Frame - 18 Module - Sonic Silver | 2314 | 1/5 |

Bold Cat.Nos are products normally available with Legrand (India) Stockists. Cat.Nos that are not bold - delivery within 4 - 8 weeks from the date of order. Bold packing quantity is our mandatory packing. Orders to be placed by Legrand (India) Stockist in multiples of the same.

Myrius™ IoT Cover Plates

| Cat.Nos | Description | MRP ₹ / Unit | Pack |
|---------|-------------|--------------------|------|
|---------|-------------|--------------------|------|

Cover Plate with Support Frame - Dark Fade

| | | | |
|----------|---|------|--------|
| 6796 01 | Cover Plate + Support Frame - 1 Module - Dark Fade | 480 | 1/5/30 |
| 6796 02 | Cover Plate + Support Frame - 2 Module - Dark Fade | 508 | 1/5/30 |
| 6796 03 | Cover Plate + Support Frame - 3 Module - Dark Fade | 540 | 1/20 |
| 6796 04 | Cover Plate + Support Frame - 4 Module - Dark Fade | 584 | 1/20 |
| 6796 06 | Cover Plate + Support Frame - 6 Module - Dark Fade | 1044 | 1/10 |
| 6796 08 | Cover Plate + Support Frame - 8 Module - Horizontal - Dark Fade | 1140 | 1/10 |
| 6796 09 | Cover Plate + Support Frame - 2*4 Module - Vertical - Dark Fade | 1428 | 1/5 |
| 6796 12 | Cover Plate + Support Frame - 12 Module - Dark Fade | 1728 | 1/5 |
| 6796 16 | Cover Plate + Support Frame - 16 Module - Dark Fade | 2010 | 1/5 |
| *6796 17 | Cover Plate + Support Frame - 16 Module(Big) - Dark Fade | 2134 | 1/5 |
| 6796 18 | Cover Plate + Support Frame - 18 Module - Dark Fade | 2314 | 1/5 |

Cover Plate with Support Frame - Ice Graphite

| | | | |
|---------|---|-----|--------|
| 6797 21 | Cover Plate + Support Frame - 1 Module - Ice Graphite | 352 | 1/5/30 |
| 6797 22 | Cover Plate + Support Frame - 2 Module - Ice Graphite | 372 | 1/5/30 |
| 6797 23 | Cover Plate + Support Frame - 3 Module - Ice Graphite | 396 | 1/20 |
| 6797 24 | Cover Plate + Support Frame - 4 Module - Ice Graphite | 422 | 1/20 |
| 6797 26 | Cover Plate + Support Frame - 6 Module - Ice Graphite | 766 | 1/10 |

Myrius™ IoT Cover Plates

| Cat.Nos | Description | MRP ₹ / Unit | Pack |
|---------|-------------|--------------------|------|
|---------|-------------|--------------------|------|

| | | | |
|----------|--|------|------|
| 6797 28 | Cover Plate + Support Frame - 8 Module - Horizontal - Ice Graphite | 834 | 1/10 |
| 6797 29 | Cover Plate + Support Frame - 2*4 Module - Vertical - Ice Graphite | 1046 | 1/5 |
| 6797 32 | Cover Plate + Support Frame - 12 Module - Ice Graphite | 1264 | 1/5 |
| 6797 36 | Cover Plate + Support Frame - 16 Module - Ice Graphite | 1476 | 1/5 |
| *6797 37 | Cover Plate + Support Frame - 16 Module(Big) - Ice Graphite | 1566 | 1/5 |
| 6797 38 | Cover Plate + Support Frame - 18 Module - Ice Graphite | 1694 | 1/5 |

Cover Plate with Support Frame - Ice Silk

| | | | |
|----------|--|------|--------|
| 6797 41 | Cover Plate + Support Frame - 1 Module - Ice Silk | 352 | 1/5/30 |
| 6797 42 | Cover Plate + Support Frame - 2 Module - Ice Silk | 372 | 1/5/30 |
| 6797 43 | Cover Plate + Support Frame - 3 Module - Ice Silk | 396 | 1/20 |
| 6797 44 | Cover Plate + Support Frame - 4 Module - Ice Silk | 422 | 1/20 |
| 6797 46 | Cover Plate + Support Frame - 6 Module - Ice Silk | 766 | 1/10 |
| 6797 48 | Cover Plate + Support Frame - 8 Module - Horizontal - Ice Silk | 834 | 1/10 |
| 6797 49 | Cover Plate + Support Frame - 2*4 Module - Vertical - Ice Silk | 1046 | 1/5 |
| 6797 62 | Cover Plate + Support Frame - 12 Module - Ice Silk | 1264 | 1/5 |
| 6797 56 | Cover Plate + Support Frame - 16 Module - Ice Silk | 1476 | 1/5 |
| *6797 67 | Cover Plate + Support Frame - 16 Module(Big) - Ice Silk | 1566 | 1/5 |
| 6797 68 | Cover Plate + Support Frame - 18 Module - Ice Silk | 1694 | 1/5 |

* MRP - Maximum Retail Price Inclusive of all taxes including GST.
Red Cat.Nos - new products & will be coming soon

Bold Cat.Nos are products normally available with Legrand (India) Stockists. Cat.Nos that are not bold - delivery within 4 - 8 weeks from the date of order. Bold packing quantity is our mandatory packing. Orders to be placed by Legrand (India) Stockist in multiples of the same.

Myrius™ IoT Cover Plates

| Cat.Nos | Description | MRP ₹ / Unit | Pack |
|---------|-------------|--------------------|------|
|---------|-------------|--------------------|------|

Cover Plate with Support Frame - White Glass

| | | | |
|---------|---|------|--------|
| 6798 11 | Cover Plate + Support Frame - 1 Module - White Glass | 1274 | 1/5/30 |
| 6798 12 | Cover Plate + Support Frame - 2 Module - White Glass | 1296 | 1/5/30 |
| 6798 13 | Cover Plate + Support Frame - 3 Module - White Glass | 1370 | 1/20 |
| 6798 14 | Cover Plate + Support Frame - 4 Module - White Glass | 1542 | 1/20 |
| 6798 16 | Cover Plate + Support Frame - 6 Module - White Glass | 1686 | 1/10 |
| 6798 18 | Cover Plate + Support Frame - 8 Module - Horizontal - White Glass | 1826 | 1/10 |
| 6798 19 | Cover Plate + Support Frame - 2*4 Module - Vertical - White Glass | 2232 | 1/5 |
| 6798 22 | Cover Plate + Support Frame - 12 Module - White Glass | 2842 | 1/5 |
| 6798 26 | Cover Plate + Support Frame - 16 Module - White Glass | 5022 | 1/5 |
| 6798 28 | Cover Plate + Support Frame - 18 Module - White Glass | 6226 | 1/5 |

Cover Plate with Support Frame - Black Glass

| | | | |
|---------|--|------|--------|
| 6798 31 | Cover Plate + Support Frame - 1 Module - Black Glass | 1274 | 1/5/30 |
| 6798 32 | Cover Plate + Support Frame - 2 Module - Black Glass | 1296 | 1/5/30 |
| 6798 33 | Cover Plate + Support Frame - 3 Module - Black Glass | 1370 | 1/20 |
| 6798 34 | Cover Plate + Support Frame - 4 Module - Black Glass | 1542 | 1/20 |

Myrius™ IoT Cover Plates

| Cat.Nos | Description | MRP ₹ / Unit | Pack |
|---------|-------------|--------------------|------|
|---------|-------------|--------------------|------|

| | | | |
|---------|---|------|------|
| 6798 36 | Cover Plate + Support Frame - 6 Module - Black Glass | 1686 | 1/10 |
| 6798 38 | Cover Plate + Support Frame - 8 Module - Horizontal - Black Glass | 1826 | 1/10 |
| 6798 39 | Cover Plate + Support Frame - 2*4 Module - Vertical - Black Glass | 2232 | 1/5 |
| 6798 42 | Cover Plate + Support Frame - 12 Module - Black Glass | 2842 | 1/5 |
| 6798 46 | Cover Plate + Support Frame - 16 Module - Black Glass | 5022 | 1/5 |
| 6798 48 | Cover Plate + Support Frame - 18 Module - Black Glass | 6226 | 1/5 |

Cover Plates without Frame

| | | | |
|---------|--|-----|--------|
| 6795 05 | Cover Plate without Frame for Wireless switch - 2 Module - White | 156 | 1/5/50 |
| 6795 25 | Cover Plate without Frame for Wireless switch - 2 Module - Ice White | 350 | 1/5/50 |
| 6795 45 | Cover Plate without Frame for Wireless switch - 2 Module - Ice Black | 350 | 1/5/50 |
| 6795 65 | Cover Plate without Frame for Wireless switch - 2 Module - Pearl Champagne | 482 | 1/5/50 |
| 6795 85 | Cover Plate without Frame for Wireless switch - 2 Module - Sonic Silver | 482 | 1/5/50 |
| 6796 05 | Cover Plate without Frame for Wireless switch - 2 Module - Dark Fade | 482 | 1/5/50 |

* MRP - Maximum Retail Price Inclusive of all taxes including GST.
Red Cat.Nos - new products & will be coming soon

Bold Cat.Nos are products normally available with Legrand (India) Stockists. Cat.Nos that are not bold - delivery within 4 - 8 weeks from the date of order. Bold packing quantity is our mandatory packing. Orders to be placed by Legrand (India) Stockist in multiples of the same.

Myrius™ IoT Cover Plates

| Cat.Nos | Description | MRP* ₹ / Unit | Pack |
|---------|-------------|---------------------|------|
|---------|-------------|---------------------|------|

Accessory













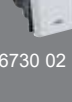

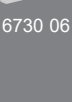

| | | | |
|---------|--|-----|------|
| 0648 71 | Pack of 3*4 Extra Removable Stickers for Fixing A Wireless Control | 806 | 1/25 |
|---------|--|-----|------|

* MRP - Maximum Retail Price Inclusive of all taxes including GST.

Bold Cat.Nos are products normally available with Legrand (India) Stockists. Cat.Nos that are not bold - delivery within 4 - 8 weeks from the date of order. Bold packing quantity is our mandatory packing. Orders to be placed by Legrand (India) Stockist in multiples of the same.

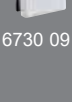
Myrius™ Regular



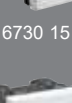







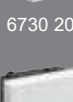





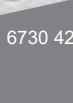

White Mechanism

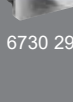
| Cat.Nos | Description | MRP* ₹ / Unit | Pack |
|---|---|------------------|----------|
| Switches – 6A - 230V AC | | | |
|  6730 00 | 6A - Switch - 1 Way - 1 Module | 174 | 1/20/200 |
|  6730 01 | 6A - Switch - 2 Way - 1 Module | 306 | 1/20/200 |
|  6730 02 | 6A - Switch - 1 Way - with Indicator - 1 Module | 282 | 1/20/200 |
|  6730 03 | 6A - Switch - 1 Way - with "Light" Marking - 1 Module | 242 | 1/20/200 |
|  6730 04 | 6A - Switch - 1 Way - with "Fan" Marking - 1 Module | 252 | 1/20/200 |
| Switches – 10A - 230V AC | | | |
|  6730 05 | 10A - Switch - 1 Way - 2 Module | 364 | 1/10/100 |
|  6730 06 | 10A - Switch - 2 Way - 2 Module | 424 | 1/10/100 |
|  6730 17 | 10A - Intermediate Switch - 230VA - 2 Module | 2376 | 1/10/100 |
|  6730 07 | 10A - Switch - 1 Way - with Indicator - 2 Module | 448 | 1/10/100 |
| Switches – 16A - 230V AC | | | |
|  6730 08 | 16A - Switch - 1 Way - 1 Module | 414 | 1/20/200 |
|  6730 09 | 16A - Switch - 2 Way - 1 Module | 478 | 1/20/200 |
|  6730 10 | 16A - Switch - 1 Way - with Indicator - 1 Module | 500 | 1/20/200 |
| Switches – 20A - 230V AC | | | |
|  6730 11 | 20A - Switch - 1 Way - 1 Module | 544 | 1/20/200 |
|  6730 12 | 20A - Switch - DP - 1 Way - 2 Module | 822 | 1/10/100 |
|  6730 13 | 20A - Switch - DP - 1 Way - with Indicator - 2 Module | 876 | 1/10/100 |
|  6730 14 | 20A - Switch - 2 Way - 2 Module | 916 | 1/10/100 |
| Switches – 25A - 230V AC | | | |
|  6730 15 | 25A - Switch - SP - 1 Way - with Indicator - 1 Module | 606 | 1/20/200 |
| Switches – 32A - 230V AC | | | |
|  6730 16 | 32A - Switch - DP - with Indicator - 2 Module | 1418 | 1/10/100 |

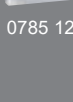
* MRP - Maximum Retail Price Inclusive of all taxes including GST.

Myrius™ Regular

White Mechanism

| Cat.Nos | Description | MRP* ₹ / Unit | Pack |
|---|---|------------------|----------|
| Push Buttons | | | |
|  6730 18 | 6A - Push Button - SP - 1 Module | 354 | 1/20/200 |
|  6730 19 | 6A - Push Button - SP - with Indicator - 1 Module | 454 | 1/20/200 |
|  6730 20 | 6A - Bell Push - 1 Module | 340 | 1/20/200 |
|  6730 21 | 6A - Bell Push - with Indicator - 1 Module | 448 | 1/20/200 |
|  6730 22 | 6A - Bell Push - 2 Module | 514 | 1/10/100 |
|  6730 23 | 6A - Bell Push - with Indicator - 2 Module | 606 | 1/10/100 |
| Accessory for Switch with Indicator | | | |
|  6732 44 | Lamp for Switches/Push Buttons | 88 | 5/50 |
| Indian Standard Sockets | | | |
|  6731 86 | 6A - Socket - with Shutter - 3 Pin - ISI - 2 Module | 284 | 1/20/200 |
|  6730 45 | 6/16A - Socket - with Shutter - ISI - 2 Module | 642 | 1/10/100 |
|  6730 83 | 6/16A - Socket - with Shutter - ISI - 3 Module | 768 | 1/5/50 |
|  6730 42 | 16A - Switched Socket - with Shutter - 3 Pin - 3 Module | 1614 | 1/5/50 |
| Dimmer and Fan Regulator | | | |
|  6730 24 | Rotary Dimmer - 400 Watts - 1 Module | 1564 | 5/50 |
|  6730 25 | Rotary Dimmer - 650 Watts - 3 Module | 3292 | 1/10 |
|  6730 26 | Compact Fluorescent Lamp Dimmer - 2 Module | 5144 | 1/10 |
|  6730 27 | Fan Step Regulator - 100 Watts - ISI - 1 Module | 1208 | 5/50 |
|  6730 29 | Fan Step Regulator - 100 Watts - ISI - 2 Module | 1390 | 10/100 |
|  6730 28 | Fan Step Regulator - 120 Watts - ISI - 2 Module | 1494 | 10/100 |
|  6730 77 | Fan Step Regulator - for Energy Saving Fans - 2 Module | 1464 | 10/100 |
| Emergency Light | | | |
|  0785 12 | Emergency Light Unit - 2 Module | 6884 | 1/1 |
| Indicators | | | |
|  0785 73 | Triangular Bulkhead - Blue - 2 Module | 366 | 1/1 |
|  0785 71 | Triangular Bulkhead - Colourless - 2 Module | 366 | 1/1 |
| 0785 72 | Triangular Bulkhead - Green - 2 Module | 404 | 1/1 |
| 0785 70 | Triangular Bulkhead - 2 Module - Red | 404 | 1/1 |

Bold Cat.Nos are products normally available with Legrand (India) Stockists. Cat.Nos that are not bold - delivery within 4 - 8 weeks from the date of order. Bold packing quantity is our mandatory packing. Orders to be placed by Legrand (India) Stockist in multiples of the same.

Myrius™ Regular

White Mechanism

| Cat.Nos | Description | MRP* ₹ / Unit | Pack |
|---------|-------------|------------------|------|
|---------|-------------|------------------|------|

Skirting Light

| | | | |
|---------|--|------|----------|
| 6730 36 | Skirting Light - with White LED - 3 Module | 1220 | 1/10/100 |
|---------|--|------|----------|

Bell Indicator

| | | | |
|---------|--|------|----------|
| 6730 33 | Bell Call Indicator - 240VA - 1 Module | 1634 | 1/20/200 |
|---------|--|------|----------|

Buzzer

| | | | |
|---------|---------------------------|------|----------|
| 6730 34 | Buzzer - 230VA - 1 Module | 1420 | 1/20/200 |
|---------|---------------------------|------|----------|

Remote Wnit

| | | | |
|---------|----------------------------------|-------|--------|
| 6730 73 | Remote Control Switch - 4 Module | 12344 | 1/5/20 |
|---------|----------------------------------|-------|--------|

Hospitality Funtions

Hotel Keycard Switch

| | | | |
|---------|--|------|----------|
| 6730 37 | 15A - Key Card Switch - Monobloc with Plate - 2 Module | 5726 | 1/10 |
| 6732 37 | 15A - Key Card Switch - Monobloc with New Plate - 2 Module | 6594 | 1/10 |
| 6730 38 | Key Fob for Key Card Switch | 298 | 1/10/100 |

Hotel "DND and MMR" functions

| | | | |
|---------|---|------|----------|
| 6730 39 | External DND & MMR Control Unit - with Bell Push - 2 Module | 2440 | 1/10/100 |
| 6730 40 | Internal DND & MMR Control Unit - 2 Module | 1628 | 1/10/100 |

Shaver Socket

| | | | |
|---------|--|------|--------|
| 6730 49 | Shaver Socket - 230V/120 - 230V - Monobloc with Plate - 4 Module | 7262 | 1/5/20 |
| 6730 79 | Shaver Socket - 230V/120 - 230V - Monobloc with New Plate - 4 Module | 7618 | 1/5/20 |

TV Socket

| | | | |
|---------|---------------------------------|-----|----------|
| 6730 50 | TV Co - axial Socket - 1 Module | 312 | 1/20/200 |
|---------|---------------------------------|-----|----------|

Data & Voice Socket

| | | | |
|---------|--|-----|----------|
| 6730 52 | Telephone Socket - RJ11 - with Transparent Shutter - 1 Module | 310 | 1/20/200 |
| 6730 53 | Telephone Socket - Double RJ11 - with Shutter - 1 Module | 476 | 1/20/200 |
| 6730 54 | Information Socket - RJ45 - Cat 5E - UTP - Toolless Systems - 1 Module | 626 | 1/20/200 |
| 6730 55 | Information Socket - RJ45 - Cat 6 - UTP - 1 Module | 977 | 1/20/200 |
| 6730 56 | Information Socket - RJ45 - Cat 6 - UTP - 2 Module | 942 | 1/10/100 |

USB Chargers (IS13252 (Part 1) / IEC 60950-1)

| | | | |
|---------|--|------|----------|
| 6731 62 | USB Charger - 1500mA - Type A - 1 Module | 2190 | 1/10/100 |
|---------|--|------|----------|

Myrius™ Regular

White Mechanism

| Cat.Nos | Description | MRP* ₹ / Unit | Pack |
|---------|-------------|------------------|------|
|---------|-------------|------------------|------|

Audio & Video Connector

| | | | |
|---------|-------------------------|------|------|
| 6730 57 | 3*Female RCA - 1 Module | 4270 | 1/10 |
|---------|-------------------------|------|------|

Sound (Volume Controller)

| | | | |
|---------|---|------|----------|
| 6730 63 | Suitable for 8Ohms - 3 Watts - (RNS) Speaker - 2 Module | 2038 | 1/10/100 |
|---------|---|------|----------|

Protectors and Accessories

Motor Starter

| | | | |
|---------|--------------------------------|------|----------|
| 6730 30 | 16A - Motor Starter - 2 Module | 996 | 1/10/100 |
| 6730 31 | 25A - Motor Starter - 2 Module | 1024 | 1/10/100 |

Modular MCB (IS : 60898-1:2002)

| | | | |
|---------|---|-----|----------|
| 6730 64 | 16A - SP - Modular MCB - C Curve - 1 Module | 592 | 1/10/100 |
| 6730 65 | 20A - SP - Modular MCB - C Curve - 1 Module | 592 | 1/10/100 |
| 6732 05 | 25A - SP - Modular MCB - C Curve - 1 Module | 592 | 1/10/100 |
| 6732 07 | 32A - SP - Modular MCB - C Curve - 1 Module | 592 | 1/10/100 |

Accessories

| | | | |
|---------|-----------------------------------|-----|----------|
| 6730 60 | Cable Outlet - 8mm - 1 Module | 386 | 1/20/200 |
| 6730 61 | Blanking Plate - 1 Module | 80 | 1/40/400 |
| 6730 62 | Blanking Plate - 2 Module | 92 | 1/10/100 |
| 0802 90 | Panel Mounting Support - 1 Module | 266 | 10/200 |
| 0802 91 | Panel Mounting Support - 2 Module | 278 | 10/200 |

White Antibacterial- Mechanism

| | | | |
|---------|--|------|----------|
| 6730 84 | 6A - Switch - 1 Way - 1 Module | 270 | 1/20/200 |
| 6730 85 | 6A - Switch - 2 Way - 1 Module | 372 | 1/20/200 |
| 6730 86 | 6A - Bell Push - 1 Module | 420 | 1/20/200 |
| 6730 89 | 16A - Switch - 1 Way - 1 Module | 500 | 1/20/200 |
| 6730 90 | 16A - Switch - 2 Way - 1 Module | 578 | 1/20/200 |
| 6730 92 | Fan Regulator - 120 Watts - ISI - 2 Module | 1884 | 10/100 |
| 6731 87 | 6A - Socket - 3 Pin - ISI - 2 Module | 350 | 1/20/200 |
| 6730 95 | 6/16A - Socket - ISI - 3 Module | 926 | 1/5/50 |
| 0787 00 | Equipotential Socket - 1 Module - Anti - Bacterial | 2024 | 1/10 |
| 6730 98 | TV Co - axial Socket - 1 Module | 384 | 1/20/200 |
| 6730 99 | Telephone Socket - RJ11 - 1 Module | 384 | 1/20/200 |
| 6730 81 | Information Socket - RJ45 - Cat 6 - UTP - 1 Module | 1139 | 1/20/200 |
| 6730 82 | Blanking Plate - 1 Module | 70 | 1/40/400 |

* MRP - Maximum Retail Price Inclusive of all taxes including GST.

Bold Cat.Nos are products normally available with Legrand (India) Stockists. Cat.Nos that are not bold - delivery within 4 - 8 weeks from the date of order. Bold packing quantity is our mandatory packing. Orders to be placed by Legrand (India) Stockist in multiples of the same.

Myrius™ Regular

White Antibacterial Mechanism

| Cat.Nos | Description | MRP* ₹ / Unit | Pack |
|----------------------------------|--|------------------|--------|
| Antibacterial Accessories | | | |
| 6732 45 | Cover Plate with Support Frame - 1 Module | 292 | 20/200 |
| 6732 46 | Cover Plate with Support Frame - 2 Module | 334 | 20/200 |
| 6732 47 | Cover Plate with Support Frame - 3 Module | 376 | 10/100 |
| 6732 48 | Cover Plate with Support Frame - 4 Module | 404 | 10/100 |
| 6732 49 | Cover Plate with Support Frame - Horizontal - 8 Module | 778 | 5/50 |
| 6732 50 | Cover Plate with Support Frame - (4*2) 8 Module | 980 | 5/25 |
| 6732 52 | Cover Plate with Support Frame - 16 Module | 1358 | 1/10 |



Myrius™ Regular

Black Mechanism

| | | | |
|---------------------------------|---|------|----------|
| Switches – 6A - 230V AC | | | |
| 6731 00 | 6A - Switch - 1 Way - 1 Module | 220 | 1/20/200 |
| 6731 01 | 6A - Switch - 2 Way - 1 Module | 352 | 1/20/200 |
| 6731 02 | 6A - Switch - 1 Way - with Indicator - 1 Module | 384 | 1/20/200 |
| 6731 03 | 6A - Switch - 1 Way - with "Light" Marking - 1 Module | 294 | 1/20/200 |
| 6731 04 | 6A - Switch - 1 Way - with "Fan" Marking - 1 Module | 294 | 1/20/200 |
| Switches – 10A - 230V AC | | | |
| 6731 05 | 10A - Switch - 1 Way - 2 Module | 442 | 1/10/100 |
| 6731 06 | 10A - Switch - 2 Way - 2 Module | 478 | 1/10/100 |
| 6731 17 | 10A - Intermediate Switch - 230VA - 2 Module | 2740 | 1/10/100 |
| 6731 07 | 10A - Switch - 1 Way - with Indicator - 2 Module | 510 | 1/10/100 |
| Switches – 16A - 230V AC | | | |
| 6731 08 | 16A - Switch - 1 Way - 1 Module | 460 | 1/20/200 |
| 6731 09 | 16A - Switch - 2 Way - 1 Module | 556 | 1/20/200 |
| 6731 10 | 16A - Switch - 1 Way - with Indicator - 1 Module | 578 | 1/20/200 |
| Switches – 20A - 230V AC | | | |
| 6731 11 | 20A - Switch - 1 Way - 1 Module | 620 | 1/20/200 |
| 6731 12 | 20A - Switch - DP - 1 Way - 2 Module | 976 | 1/10/100 |
| 6731 13 | 20A - Switch - DP - 1 Way - with Indicator - 2 Module | 1030 | 1/10/100 |
| 6731 14 | 20A - Switch - 2 Way - 2 Module | 1066 | 1/10/100 |

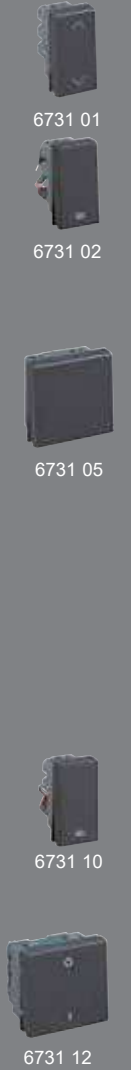

Myrius™ Regular

Black Mechanism

| Cat.Nos | Description | MRP* ₹ / Unit | Pack |
|--|---|------------------|----------|
| Switches – 25A - 230V AC | | | |
| 6731 15 | 25A - Switch - SP - 1 Way - with Indicator - 1 Module | 708 | 1/20/200 |
| Switches – 32A - 230V AC | | | |
| 6731 16 | 32A - Switch - DP - with Indicator - 2 Module | 1640 | 1/10/100 |
| Push Buttons | | | |
| 6731 18 | 6A - Push Button - SP - 1 Module | 408 | 1/20/200 |
| 6731 19 | 6A - Push Button - SP - with Indicator - 1 Module | 516 | 1/20/200 |
| 6731 20 | 6A - Bell Push - 1 Module | 388 | 1/20/200 |
| 6731 21 | 6A - Bell Push - with Indicator - 1 Module | 516 | 1/20/200 |
| 6731 22 | 6A - Bell Push - 2 Module | 598 | 1/10/100 |
| 6731 23 | 6A - Bell Push - with Indicator - 2 Module | 708 | 1/10/100 |
| Accessories for Switches with Indicator | | | |
| 6732 44 | Lamp for Switches/Push Buttons | 88 | 5/50 |
| Indian Standard Sockets | | | |
| 6721 03 | 6A - Socket - with Shutter - 3 Pin - ISI - 2 Module | 318 | 1/20/200 |
| 6731 45 | 6/16A - Socket - with Shutter - ISI - 2 Module | 752 | 1/10/100 |
| 6731 83 | 6/16A - Socket - with Shutter - ISI - 3 Module | 890 | 1/5/50 |
| 6731 42 | 16A - Switched Socket - with Shutter - 3 Pin - 3 Module | 1876 | 1/5/50 |
| Socket - Red | | | |
| 6730 48 | 16A - Switched Socket - with Shutter - 3 Module - Red | 1664 | 1/5/50 |
| Dimmers & Regulators | | | |
| 6731 24 | Rotary Dimmer - 400 Watts - 1 Module | 1796 | 5/50 |
| 6731 25 | Rotary Dimmer - 650 Watts - 3 Module | 3802 | 1/10 |
| 6731 27 | Fan Step Regulator - 100 Watts - ISI - 1 Module | 1424 | 5/50 |
| 6731 29 | Fan Step Regulator - 100 Watts - ISI - 2 Module | 1610 | 10/100 |
| 6731 28 | Fan Step Regulator - 120 Watts - ISI - 2 Module | 1768 | 10/100 |
| 6731 77 | Fan Step Regulator - for Energy Saving Fans - 2 Module | 1708 | 10/100 |



* MRP - Maximum Retail Price Inclusive of all taxes including GST.

Bold Cat.Nos are products normally available with Legrand (India) Stockists. Cat.Nos that are not bold - delivery within 4 - 8 weeks from the date of order. Bold packing quantity is our mandatory packing. Orders to be placed by Legrand (India) Stockist in multiples of the same.

Myrius™ Regular

Black Mechanism

| Cat.Nos | Description | MRP* ₹ / Unit | Pack |
|---------|-------------|------------------|------|
|---------|-------------|------------------|------|

Skirting Light

| | | | |
|---------|--|------|----------|
| 6731 36 | Skirting Light - with White LED - 3 Module | 1406 | 1/10/100 |
|---------|--|------|----------|

Bell Indicator

| | | | |
|---------|--|------|----------|
| 6731 33 | Bell Call Indicator - 240VA - 1 Module | 1936 | 1/20/200 |
|---------|--|------|----------|

Buzzer

| | | | |
|---------|--|------|----------|
| 6731 34 | Buzzer - 230VA - Sound Level 72Db At 1 Meter Distance - 1 Module | 1662 | 1/20/200 |
|---------|--|------|----------|

Remote Unit

| | | | |
|---------|----------------------------------|-------|--------|
| 6731 73 | Remote Control Switch - 4 Module | 14328 | 1/5/20 |
|---------|----------------------------------|-------|--------|

Hospitality Functions

Hotel Keycard Switch

| | | | |
|---------|---|------|----------|
| 6731 37 | 15A - Key Card Switch - with Timedelay 30 Sec. - Monobloc with Plate - 2 Module | 6570 | 1/10 |
| 6732 67 | 15A - Key Card Switch - Monobloc with New Plate - 2 Module | 7672 | 1/10 |
| 6730 38 | Key Fob for Key Card Switch | 298 | 1/10/100 |

Hotel "DND and MMR" Functions

| | | | |
|---------|---|------|----------|
| 6731 39 | External DND & MMR Control Unit - with Bell Push - 2 Module | 2800 | 1/10/100 |
| 6731 40 | Internal DND & MMR Control Unit - 2 Module | 1868 | 1/10/100 |

Shaver Socket

| | | | |
|---------|--|------|--------|
| 6731 49 | Shaver Socket - 220/240V - 50/60Hz - Monobloc with Plate - 4 Module | 7966 | 1/5/20 |
| 6731 79 | Shaver Socket - 230V/120 - 230V - Monobloc with New Plate - 4 Module | 8382 | 1/5/20 |

TV Socket

| | | | |
|---------|---------------------------------|-----|----------|
| 6731 50 | TV Co - axial Socket - 1 Module | 384 | 1/20/200 |
|---------|---------------------------------|-----|----------|

Data & Voice Socket

| | | | |
|---------|---|------|----------|
| 6731 52 | Telephone Socket - RJ11 - with Transparent Shutter - 1 Module | 368 | 1/20/200 |
| 6731 53 | Telephone Socket - Double RJ11 - with Shutter - 1 Module | 564 | 1/20/200 |
| 6731 54 | Information Socket - RJ45 - Cat 5E - 1 Module | 686 | 1/20/200 |
| 6731 55 | Information Socket - RJ45 - Cat 6 - UTP - 1 Module | 1047 | 1/20/200 |
| 6731 56 | Information Socket - RJ45 - Cat 6 - UTP - 2 Module | 1055 | 1/10/100 |

Myrius™ Regular

Plates with Frame

| Cat.Nos | Description | MRP* ₹ / Unit | Pack |
|---------|-------------|------------------|------|
|---------|-------------|------------------|------|

USB Chargers (IS13252 (Part 1) / IEC 60950-1)

| | | | |
|---------|--|------|----------|
| 6731 72 | USB Charger - 1500mA - Type A - 1 Module | 2522 | 1/10/100 |
|---------|--|------|----------|

Audio & Video Connector

| | | | |
|---------|-------------------------------|------|----------|
| 6731 57 | 3*Female RCA - 1 Module | 4916 | 1/10 |
| 6731 58 | 3 Pole XLR Sockets - 2 Module | 4636 | 1/10/100 |

Sound

| | | | |
|---------|---|------|----------|
| 6731 63 | Suitable for 8Ohms - 3 Watts - (RNS) Speaker - 2 Module | 2364 | 1/10/100 |
|---------|---|------|----------|

Protectors & Accessories

Motor Starter

| | | | |
|---------|--------------------------------|------|----------|
| 6731 30 | 16A - Motor Starter - 2 Module | 1174 | 1/10/100 |
| 6731 31 | 25A - Motor Starter - 2 Module | 1200 | 1/10/100 |

Modular MCB (IS : 60898-1:2002)

| | | | |
|---------|---|-----|----------|
| 6731 64 | 16A - SP - Modular MCB - C Curve - 1 Module | 688 | 1/10/100 |
| 6731 65 | 20A - SP - Modular MCB - C Curve - 1 Module | 688 | 1/10/100 |

Accessories

| | | | |
|---------|-------------------------------|-----|----------|
| 6731 60 | Cable Outlet - 8mm - 1 Module | 466 | 1/20/200 |
| 6731 61 | Blanking Plate - 1 Module | 90 | 1/40/400 |

Cover plates with Support Frames

White Cover Plates with Support Frame

| | | | |
|---------|---|------|--------|
| 6732 01 | Cover Plate - 1 Module - White | 288 | 20/200 |
| 6732 02 | Cover Plate - 2 Module - White | 312 | 20/200 |
| 6732 03 | Cover Plate - 3 Module - White | 328 | 10/100 |
| 6732 04 | Cover Plate - 4 Module - White | 352 | 10/100 |
| 6732 06 | Cover Plate - 6 Module - White | 634 | 5/50 |
| 6732 08 | Cover Plate - 8 Module - Horizontal - White | 702 | 5/50 |
| 6732 09 | Cover Plate - 2*4 Module - Vertical - White | 872 | 5/25 |
| 6732 12 | Cover Plate - 12 Module - White | 1056 | 1/10 |
| 6732 16 | Cover Plate - 16 Module - White | 1220 | 1/10 |
| 6732 18 | Cover Plate - 18 Module - White | 1406 | 1/10 |



6731 63



6732 01



6732 03

* MRP - Maximum Retail Price Inclusive of all taxes including GST.

Bold Cat.Nos are products normally available with Legrand (India) Stockists. Cat.Nos that are not bold - delivery within 4 - 8 weeks from the date of order. Bold packing quantity is our mandatory packing. Orders to be placed by Legrand (India) Stockist in multiples of the same.

Myrius™ Regular

Plates with Frame

| Cat.Nos | Description | MRP* ₹ / Unit | Pack |
|---------|-------------|------------------|------|
|---------|-------------|------------------|------|

New White Cover Plates with Support Frame*

| | | | |
|---------|---|------|--------|
| 6732 11 | Cover Plate - 1 Module - New White | 300 | 20/200 |
| 6732 42 | Cover Plate - 2 Module - New White | 318 | 20/200 |
| 6732 13 | Cover Plate - 3 Module - New White | 346 | 10/100 |
| 6732 14 | Cover Plate - 4 Module - New White | 366 | 10/100 |
| 6732 66 | Cover Plate - 6 Module - New White | 716 | 5/50 |
| 6732 68 | Cover Plate - 8 Module - Horizontal - New White | 764 | 5/50 |
| 6732 69 | Cover Plate - 2*4 Module - Vertical - New White | 958 | 5/25 |
| 6732 62 | Cover Plate - 12 Module - New White | 1162 | 1/10 |
| 6732 56 | Cover Plate - 16 Module - New White | 1352 | 1/10 |
| 6732 58 | Cover Plate - 18 Module - New White | 1552 | 1/10 |

Black Cover Plates with Support Frame

| | | | |
|---------|---|------|--------|
| 6732 21 | Cover Plate - 1 Module - Black | 496 | 20/200 |
| 6732 22 | Cover Plate - 2 Module - Black | 534 | 20/200 |
| 6732 23 | Cover Plate - 3 Module - Black | 566 | 10/100 |
| 6732 24 | Cover Plate - 4 Module - Black | 630 | 10/100 |
| 6732 26 | Cover Plate - 6 Module - Black | 1092 | 5/50 |
| 6732 28 | Cover Plate - 8 Module - Horizontal - Black | 1218 | 5/50 |
| 6732 29 | Cover Plate - 2*4 Module - Vertical - Black | 1500 | 5/25 |
| 6732 32 | Cover Plate - 12 Module - Black | 1790 | 1/10 |
| 6732 36 | Cover Plate - 16 Module - Black | 2100 | 1/10 |
| 6732 38 | Cover Plate - 18 Module - Black | 2380 | 1/10 |

New Black Cover Plates with Support Frame

| | | | |
|---------|---|------|--------|
| 6732 31 | Cover Plate - 1 Module - New Black | 562 | 20/200 |
| 6732 82 | Cover Plate - 2 Module - New Black | 618 | 20/200 |
| 6732 33 | Cover Plate - 3 Module - New Black | 662 | 10/100 |
| 6732 34 | Cover Plate - 4 Module - New Black | 716 | 10/100 |
| 6732 86 | Cover Plate - 6 Module - New Black | 1264 | 5/50 |
| 6732 88 | Cover Plate - 8 Module - Horizontal - New Black | 1380 | 5/50 |
| 6732 89 | Cover Plate - 2*4 Module - Vertical - New Black | 1724 | 5/25 |
| 6732 92 | Cover Plate - 12 Module - New Black | 2074 | 1/10 |
| 6732 96 | Cover Plate - 16 Module - New Black | 2418 | 1/10 |
| 6732 98 | Cover Plate - 18 Module - New Black | 2728 | 1/10 |

* MRP - Maximum Retail Price Inclusive of all taxes including GST.

Myrius™ Regular

Mounting Boxes

| Cat.Nos | Description | MRP* ₹ / Unit | Pack |
|---------|-------------|------------------|------|
|---------|-------------|------------------|------|

Accessories

Metal Flush Boxes

| | | | |
|---------|--------------------------------|-----|----|
| 6890 07 | Metal Flush Box - 1/2 Module | 170 | 40 |
| 6890 08 | Metal Flush Box - 3 Module | 170 | 40 |
| 6890 09 | Metal Flush Box - 4 Module | 226 | 40 |
| 6890 10 | Metal Flush Box - 6 Module | 358 | 40 |
| 6890 42 | Metal Flush Box - 8 Module | 416 | 40 |
| 6890 31 | Metal Flush Box - 2*4 Module | 414 | 20 |
| 6890 11 | Metal Flush Box - 12/16 Module | 624 | 10 |
| 6890 12 | Metal Flush Box - 18/24 Module | 788 | 10 |

Plastic Surface Boxes

| | | | |
|---------|----------------------------------|-----|-------|
| 6733 02 | Plastic Surface Box - 1/2 Module | 100 | 10/50 |
| 6733 03 | Plastic Surface Box - 3 Module | 114 | 5/35 |
| 6733 04 | Plastic Surface Box - 4 Module | 134 | 5/25 |
| 6733 06 | Plastic Surface Box - 6 Module | 172 | 1/10 |
| 6733 08 | Plastic Surface Box - 8 Module | 254 | 1/5 |
| 6733 05 | Plastic Surface Box - 2*4 Module | 240 | 1/5 |

Metal Surface Boxes

| | | | |
|---------|--|-----|-----|
| 6890 21 | Metal Surface Box - 12 Module (2 Rows*6) | 600 | 1/6 |
| 6890 22 | Metal Surface Box - 18 Module (3 Rows*6) | 634 | 1/4 |

Bold Cat.Nos are products normally available with Legrand (India) Stockists. Cat.Nos that are not bold - delivery within 4 - 8 weeks from the date of order. Bold packing quantity is our mandatory packing. Orders to be placed by Legrand (India) Stockist in multiples of the same.

Myrius™

Guarantee

- The Company, at its discretion, will replace products if they have any manufacturing defect within 10 years for switches (without LED lamp) and power sockets. For all other **Myrius™** wiring accessories the guarantee will be 2 years.
- The above guarantee is applicable when the devices are used in Legrand metal flush boxes. Otherwise the guarantee period will be reduced by 50%.
- The guarantee is only applicable when the products are installed as per the Company's instructions and not tampered in any manner.
- The guarantee states the Company's entire liability. It does not extend to cover consequential loss or damage or installation costs arising from defective products.

Our switches are compliant with revised BIS standard (IS 3854:2023) requirements. Also, our switches are covered additionally for use on Self-Ballasted Lamp (SBL) loads.

SBL power rating as per IS3854:2023

| Switch Rating | 6A, 230V~ | 10A, 230V~ | 16A, 230V~ | 20A, 230V~ |
|------------------|-----------|------------|------------|------------|
| SBL power (Watt) | 100 W | 100 W | 200 W | 250 W |

Mylinc™

A little touch of genius

Reliable Modular Wiring for Devices



Mylinc™ is a modular wiring accessories range designed and manufactured in India for residential and commercial installations. Combining dependable mechanisms with practical design, it delivers reliability, convenience, and aesthetically consistent electrical solutions.

Features

- Durable mechanisms tested for up to 1 lakh operations
- Installer-friendly design with Linc-Loc™ alignment, front removal, and orientation indicators
- Enhanced safety with finger-proof IP20 terminals and shuttered sockets
- Quality assurance and laser markings, ISI and CE certification

Benefits

- Ensures long-term reliability with certified and durable components
- Simplifies installation with alignment aids and easy access mechanisms
- Enhances electrical safety through protected terminals and compliant designs
- Supports modern spaces with integrated power, lighting, and connectivity solutions

Scan to know more about the product.



Product Range



Silver Alu



Pearl White



Dark Bronze



Matt Grey



White



Champagne

Myline™

White- Mechanism

| Cat.Nos | Description | MRP* ₹ / Unit | Pack |
|---------|-------------|------------------|------|
|---------|-------------|------------------|------|

Switches and Accessories

Switches 6A - 230V AC

| | | | |
|---------|--|-----|--------|
| 6755 01 | 6A - Switch - SP - 1 Way - 1 Module | 112 | 20/400 |
| 6755 02 | 6A - Switch - SP - 2 Way - 1 Module | 226 | 20/200 |
| 6755 03 | 6A - Switch - SP - 1 Way - with Indicator - 1 Module | 254 | 20/200 |

Switches - 10A - 230V AC

| | | | |
|---------|--|-----|--------|
| 6755 85 | 10A - Switch - 1 Way - 1 Module | 122 | 20/400 |
| 675593 | 10A - Switch - 2 Way - 1 Module | 236 | 20/200 |
| 675594 | 10A - Switch - 1 Way - with Indicator - 1 Module | 266 | 20/200 |

Switches 16A - 230V AC

| | | | |
|---------|---|-----|--------|
| 6755 11 | 16A - Switch - SP - 1 Way - 1 Module | 256 | 20/200 |
| 6755 12 | 16A - Switch - SP - 2 Way - 1 Module | 322 | 20/200 |
| 6755 13 | 16A - Switch - SP - 1 Way - with Indicator - 1 Module | 336 | 20/200 |

Switch 25A - 230V AC

| | | | |
|---------|--|-----|--------|
| 6759 68 | 25A - Switch - with Indicator - 1 Module | 518 | 10/100 |
|---------|--|-----|--------|

Switches 32A - 230V AC

| | | | |
|---------|---|-----|--------|
| 6755 26 | 32A - Switch - DP - 1 Way - with Indicator - 2 Module | 764 | 10/100 |
|---------|---|-----|--------|

Push buttons 6A - 230V AC

| | | | |
|---------|---|-----|--------|
| 6755 04 | 6A - Bell Push - SP - 1 Way - 1 Module | 236 | 20/200 |
| 6755 06 | 6A - Bell Push - SP - 1 Way - with Indicator - 2 Module | 468 | 10/100 |

Indian Standard Sockets

| | | | |
|---------|--|-----|--------|
| 6755 51 | 6A - Socket - with Shutter - 3 Pin - ISI - 2 Module | 310 | 20/200 |
| 6755 55 | 6/16A - Socket - with Shutter - 3 Pin - Combine - ISI - 2 Module | 476 | 10/100 |

Bell Call Indicator & Register - 6A - 230V AC

| | | | |
|---------|--|------|--------|
| 6755 07 | 6A - Bell Call Indicator - SP - with Register - 1 Way - 1 Module | 1378 | 20/200 |
|---------|--|------|--------|

Lighting Modules

| | | | |
|---------|-----------------------------------|-----|--------|
| 6755 95 | Indicator Light Red - 1 Module | 326 | 20/200 |
| 6755 96 | Indicator Light Orange - 1 Module | 326 | 20/200 |

Skirting Light

| | | | |
|---------|--|------|--------|
| 6755 97 | Skirting Light - with White LED - 3 Module | 1044 | 10/100 |
| 6759 76 | Skirting Light - with White LED - 2 Module | 696 | 5/50 |

Myline™

White- Mechanism

| Cat.Nos | Description | MRP* ₹ / Unit | Pack |
|---------|-------------|------------------|------|
|---------|-------------|------------------|------|

Dimmers and Fan Regulators

| | | | |
|---------|---|------|----------|
| 6755 35 | Rotative Dimmer - 60/250 Watts - for Light - 2 Module | 868 | 10/100 |
| 6755 33 | Dimmer - 400 Watts - for Light - 1 Module | 1102 | 1/5/50 |
| 6755 31 | Fan Regulator - 100 Watts - Humfree - 0 - 4 Step - 1 Module | 794 | 1/5/50 |
| 6759 64 | Fan Regulator - 100 Watts - with 360° Rotation - ISI - 2 Module | 986 | 10/100 |
| 6755 30 | Fan Regulator - 100 Watts - Humfree - 0 - 4 Step - ISI - 2 Module | 1062 | 10/100 |
| 6759 77 | Fan Regulator - 8 Step ISI - 2 Module | 1062 | 1/10/100 |
| 6759 78 | Fan Regulator - BLDC - 2 Module [^] | 1082 | 10/100 |

Buzzer

| | | | |
|---------|-------------------|-----|--------|
| 6755 40 | Buzzer - 1 Module | 786 | 20/200 |
|---------|-------------------|-----|--------|

Remote Unit

| | | | |
|---------|--|------|--------|
| 6759 75 | Remote Control Unit with Remote - for 4 Switch & Fan Load - 4 Module | 5370 | 1/5/20 |
|---------|--|------|--------|

Hospitality function

Hotel "DND and MMR" functions

| | | | |
|---------|---|-----|----------|
| 6759 69 | External DND & MMR Control Unit - with Bell Push - 2 Module | 492 | 10/100 |
| 6755 57 | Internal DND & MMR Control Unit - 2 Module | 406 | 1/10/100 |

Hotel Keycard Switch

| | | | |
|---------|--------------------------------|------|----------|
| 6755 60 | 15A Key Card Switch - 2 Module | 4470 | 1/10 |
| 6730 38 | Key Fob for Key Card Switch | 298 | 1/10/100 |

Motor Starter

| | | | |
|---------|--------------------------------|-----|----------|
| 6759 65 | 16A - Motor Starter - 2 Module | 848 | 1/10/100 |
|---------|--------------------------------|-----|----------|

Modular MCB (IS : 60898-1:2002)

| | | | |
|---------|-----------------------------------|-----|----------|
| 6759 74 | 16A - SP - Modular MCB - 1 Module | 562 | 1/10/100 |
| 6756 40 | 20A - SP - Modular MCB - 1 Module | 562 | 1/10/100 |
| 6756 41 | 25A - SP - Modular MCB - 1 Module | 562 | 1/10/100 |
| 6756 42 | 32A - SP - Modular MCB - 1 Module | 562 | 1/10/100 |

Tv Sockets

| | | | |
|---------|---------------------------------|-----|--------|
| 6755 46 | TV Co - axial Socket - 1 Module | 264 | 20/200 |
|---------|---------------------------------|-----|--------|

* MRP - Maximum Retail Price Inclusive of all taxes including GST.

[^]Compatible with Atomberg (Efficio), Havells (Efficiencia neo), Orient (Aerostorm) as per 2023 fan models.

Bold Cat.Nos are products normally available with Legrand (India) Stockists. Cat.Nos that are not bold - delivery within 4 - 8 weeks from the date of order. Bold packing quantity is our mandatory packing. Orders to be placed by Legrand (India) Stockist in multiples of the same.

Mylic™

White- Mechanism

| Cat.Nos | Description | MRP* ₹ / Unit | Pack |
|---------|-------------|------------------|------|
|---------|-------------|------------------|------|

Data and Voice

| | | | |
|---------|--|-----|--------|
| 6755 41 | Telephone Socket - RJ11 - 1 Module | 248 | 20/200 |
| 6755 44 | Telephone Socket - Double RJ11 - 1 Module | 416 | 20/200 |
| 6759 66 | Information Socket - RJ45 - Cat 5E -UTP-with Shutter - 1 Module | 562 | 20/200 |
| 6759 67 | Information Socket - RJ45 - Cat 6 - UTP-with Shutter - 1 Module | 818 | 20/200 |
| 675982 | Information Socket - RJ45 - Cat 6A - STP with shutter - 1 Module | 929 | 20/200 |

USB Chargers (IS13252(Part 1) / IEC 60950-1)

| | | | |
|---------|---|------|----------|
| 6758 20 | USB Charger - 1500mA - Type A - 1 Module | 1412 | 10/100 |
| 6755 80 | Double USB Charger - 3000mA - Type A + C - 2 Module | 3084 | 1/10/100 |
| 6757 95 | USB Charger - Power Delivery - 30 Watts - Type C + C - 2 Module | 6720 | 1/3/30 |
| 6757 96 | USB Charger - Power Delivery - 45 Watts - Type C - 2 Module | 8408 | 1/3/30 |

Accessories

| | | | |
|---------|-------------------------------|-----|--------|
| 6755 91 | Cable Outlet - 8mm - 1 Module | 224 | 20/200 |
| 6755 90 | Blanking Plate - 1 Module | 64 | 20/200 |
| 6755 92 | Spare 12 Screws with Nuts | 80 | 20/200 |

Modular Cover Plates with Support Frame

White Cover Plates with Support Frame

| | | | |
|---------|---|------|--------|
| 6755 61 | Cover Plate + Support Frame - 1 Module - White | 186 | 20/200 |
| 6755 62 | Cover Plate + Support Frame - 2 Module - White | 186 | 20/200 |
| 6755 63 | Cover Plate + Support Frame - 3 Module - White | 254 | 10/100 |
| 6755 64 | Cover Plate + Support Frame - 4 Module - White | 282 | 10/100 |
| 6755 66 | Cover Plate + Support Frame - 6 Module - White | 350 | 5/50 |
| 6755 67 | Cover Plate + Support Frame - Horizontal - 8 Module - White | 450 | 5/50 |
| 6755 68 | Cover Plate + Support Frame - 2*4 Module - Vertical - White | 458 | 1/25 |
| 6755 69 | Cover Plate + Support Frame - 9 Module - White | 538 | 5/50 |
| 6755 72 | Cover Plate + Support Frame - 12 Module - White | 660 | 10 |
| 6755 73 | Cover Plate + Support Frame - 16 Module - White | 770 | 10 |
| 6755 78 | Cover Plate + Support Frame - 18 Module - White | 1030 | 10 |

* MRP - Maximum Retail Price Inclusive of all taxes including GST.

Mylic™

Matt Grey- Mechanism

| Cat.Nos | Description | MRP* ₹ / Unit | Pack |
|---------|-------------|------------------|------|
|---------|-------------|------------------|------|

Switches – 6A - 230V AC

| | | | |
|---------|--|-----|--------|
| 6763 01 | 6A - Switch - SP - 1 Way - 1 Module | 132 | 20/200 |
| 6763 02 | 6A - Switch - SP - 2 Way - 1 Module | 244 | 20/200 |
| 6763 03 | 6A - Switch - SP - 1 Way - with Indicator - 1 Module | 286 | 20/200 |

Switches – 16A - 230V AC

| | | | |
|---------|---|-----|--------|
| 6763 11 | 16A - Switch - SP - 1 Way - 1 Module | 282 | 20/200 |
| 6763 12 | 16A - Switch - SP - 2 Way - 1 Module | 350 | 20/200 |
| 6763 13 | 16A - Switch - SP - 1 Way - with Indicator - 1 Module | 380 | 20/200 |

Switches – 25A - 230V AC

| | | | |
|---------|--|-----|--------|
| 6763 41 | 25A - Switch - with Indicator - 1 Module | 598 | 10/100 |
|---------|--|-----|--------|

Switches – 32A - 230V AC

| | | | |
|---------|---|-----|--------|
| 6763 26 | 32A - Switch - DP - 1 Way - with Indicator - 2 Module | 850 | 10/100 |
|---------|---|-----|--------|

Push Buttons – 6A - 230V AC

| | | | |
|---------|---|-----|--------|
| 6763 04 | 6A - Bell Push - SP - 1 Way - 1 Module | 256 | 20/200 |
| 6763 06 | 6A - Bell Push - SP - 1 Way - with Indicator - 2 Module | 520 | 10/100 |

Indian Standard Sockets

| | | | |
|---------|--|-----|--------|
| 6763 27 | 6A - Socket - with Shutter - 3 Pin - ISI - 2 Module | 344 | 20/200 |
| 6763 05 | 6/16A - Socket - with Shutter - 3 Pin - Combine - ISI - 2 Module | 512 | 10/100 |

Bell Call Indicator & Register - 6A - 230V AC

| | | | |
|---------|--|------|--------|
| 6763 07 | 6A - Bell Call Indicator - SP - with Register - 1 Way - 1 Module | 1520 | 20/200 |
|---------|--|------|--------|

Lighting Modules

| | | | |
|---------|-----------------------------------|-----|--------|
| 6763 14 | Indicator Light Red - 1 Module | 356 | 20/200 |
| 6763 15 | Indicator Light Orange - 1 Module | 356 | 20/200 |

Skirting Light

| | | | |
|---------|--|------|--------|
| 6763 16 | Skirting Light - with White LED - 3 Module | 1142 | 10/100 |
| 6763 10 | Skirting Light - with White LED - 2 Module | 770 | 5/50 |

Bold Cat.Nos are products normally available with Legrand (India) Stockists. Cat.Nos that are not bold - delivery within 4 - 8 weeks from the date of order. Bold packing quantity is our mandatory packing. Orders to be placed by Legrand (India) Stockist in multiples of the same.

Myline™ Matt Grey- Mechanism

| Cat.Nos | Description | MRP* ₹ / Unit | Pack |
|---------|-------------|------------------|------|
|---------|-------------|------------------|------|

Dimmers and Fan Regulators

| | | | |
|---------|---|------|----------|
| 6763 17 | Rotative Dimmer - 60/250 Watts - for Light - 2 Module | 958 | 10/100 |
| 6763 18 | Rotative Dimmer - 60/400 Watts - 1 Module | 1220 | 1/5/50 |
| 6763 20 | Fan Regulator - 100 Watts - Humfree - 0 - 4 Step - 1 Module | 868 | 1/5/50 |
| 6763 37 | Fan Regulator - 100 Watts - with 360° Rotation - ISI - 2 Module | 1084 | 10/100 |
| 6763 19 | Fan Regulator - 100 Watts - Humfree - 0 - 4 Step - ISI - 2 Module | 1166 | 10/100 |
| 6763 08 | Fan Regulator - 8 Step - ISI - 2 Module | 1162 | 1/10/100 |
| 6763 09 | Fan Regulator - BLDC - 2 Module^ | 1184 | 10/100 |

Buzzer

| | | | |
|---------|-------------------|-----|--------|
| 6763 21 | Buzzer - 1 Module | 964 | 20/200 |
|---------|-------------------|-----|--------|

Remote Unit

| | | | |
|---------|--|------|--------|
| 6763 47 | Remote Control Unit with Remote - for 4 Switch & Fan Load - 4 Module | 5908 | 1/5/20 |
|---------|--|------|--------|

Hospitality Function

Hotel "DND and MMR" functions

| | | | |
|---------|---|-----|--------|
| 6763 42 | External DND & MMR Control Unit - with Bell Push - 2 Module | 540 | 10/100 |
| 6763 23 | Internal DND & MMR Control Unit - 2 Module | 472 | 10/100 |

Hotel Keycard Switch

| | | | |
|---------|--------------------------------|------|----------|
| 6736 24 | 15A Key Card Switch - 2 Module | 4960 | 1/10 |
| 673038 | Key Fob for Key Card Switch | 298 | 1/10/100 |

Protection Devices

Motor Starter

| | | | |
|---------|--------------------------------|-----|----------|
| 6763 38 | 16A - Motor Starter - 2 Module | 938 | 1/10/100 |
|---------|--------------------------------|-----|----------|

Modular MCB (IS : 60898-1:2002)

| | | | |
|---------|-----------------------------------|-----|----------|
| 6763 46 | 16A - SP - Modular MCB - 1 Module | 628 | 1/10/100 |
|---------|-----------------------------------|-----|----------|

Tv Sockets

| | | | |
|---------|---------------------------------|-----|--------|
| 6763 32 | TV Co - axial Socket - 1 Module | 302 | 20/200 |
|---------|---------------------------------|-----|--------|

* MRP - Maximum Retail Price Inclusive of all taxes including GST.
^Compatible with Atomberg (Efficio), Havells (Efficiencia neo), Orient (Aerostorm) as per 2023 fan models.

Myline™ Matt Grey- Mechanism

| Cat.Nos | Description | MRP* ₹ / Unit | Pack |
|---------|-------------|------------------|------|
|---------|-------------|------------------|------|

Data and Voice

| | | | |
|---------|--|------|--------|
| 6763 33 | Telephone Socket - RJ11 - 1 Module | 270 | 20/200 |
| 6763 34 | Telephone Socket - Double RJ11 - 1 Module | 446 | 20/200 |
| 6763 39 | Information Socket - RJ45 - Cat 5E -UTP-with Shutter - 1 Module | 603 | 20/200 |
| 6763 40 | Information Socket - RJ45 - Cat 6 - UTP-with Shutter - 1 Module | 924 | 20/200 |
| 675983 | Information Socket - RJ45 - Cat 6A - STP with shutter - 1 Module | 1072 | 20/200 |

USB Chargers (IS13252(Part 1) / IEC 60950-1)

| | | | |
|---------|---|------|----------|
| 6758 21 | USB Charger - 1500mA - Type A - 1 Module | 1554 | 10/100 |
| 6764 80 | Double USB Charger - 3000mA - Type A + C - 2 Module | 3538 | 1/10/100 |
| 6766 56 | USB Charger - Power Delivery - 30 Watts - Type C + C - 2 Module | 7232 | 1/3/30 |
| 6766 57 | USB Charger - Power Delivery - 45 Watts - Type C - 2 Module | 9402 | 1/3/30 |

Accessories

| | | | |
|---------|-------------------------------|-----|--------|
| 6763 48 | Cable Outlet - 8mm - 1 Module | 256 | 20/200 |
| 6763 49 | Blanking Plate - 1 Module | 72 | 20/200 |

Bold Cat.Nos are products normally available with Legrand (India) Stockists. Cat.Nos that are not bold - delivery within 4 - 8 weeks from the date of order. Bold packing quantity is our mandatory packing. Orders to be placed by Legrand (India) Stockist in multiples of the same.

Myline™ Cover Plate

| Cat.Nos | Description | MRP* ₹ / Unit | Pack |
|---------|-------------|------------------|------|
|---------|-------------|------------------|------|

Modular Cover Plates with Support Frame Matt Grey Cover Plates with Support Frame

| | | | |
|---------|---|------|--------|
| 6763 50 | Cover Plate + Support Frame - 1 Module - Matt Grey | 242 | 20/200 |
| 6763 51 | Cover Plate + Support Frame - 2 Module - Matt Grey | 242 | 20/200 |
| 6763 52 | Cover Plate + Support Frame - 3 Module - Matt Grey | 340 | 10/100 |
| 6763 53 | Cover Plate + Support Frame - 4 Module - Matt Grey | 358 | 10/100 |
| 6763 54 | Cover Plate + Support Frame - 6 Module - Matt Grey | 456 | 5/50 |
| 6763 55 | Cover Plate + Support Frame - 8 Module - Horizontal - Matt Grey | 588 | 5/50 |
| 6763 56 | Cover Plate + Support Frame - 2*4 Module - Vertical - Matt Grey | 602 | 5/25 |
| 6763 57 | Cover Plate + Support Frame - 9 Module - Matt Grey | 700 | 5/50 |
| 6763 58 | Cover Plate + Support Frame - 12 Module - Matt Grey | 854 | 10 |
| 6763 59 | Cover Plate + Support Frame - 18 Module - Matt Grey | 1354 | 10 |

Pearl White Cover Plates with Support Frame

| | | | |
|---------|---|------|--------|
| 6763 60 | Cover Plate + Support Frame - 1 Module - Pearl White | 230 | 10/100 |
| 6763 61 | Cover Plate + Support Frame - 2 Module - Pearl White | 230 | 10/100 |
| 6763 62 | Cover Plate + Support Frame - 3 Module - Pearl White | 304 | 10/100 |
| 6763 63 | Cover Plate + Support Frame - 4 Module - Pearl White | 332 | 10/100 |
| 6763 64 | Cover Plate + Support Frame - 6 Module - Pearl White | 436 | 5/50 |
| 6763 65 | Cover Plate + Support Frame - 8 Module - Horizontal - Pearl White | 550 | 5/50 |
| 6763 66 | Cover Plate + Support Frame - 2*4 Module - Vertical - Pearl White | 562 | 5/25 |
| 6763 67 | Cover Plate + Support Frame - 9 Module - Pearl White | 644 | 5/50 |
| 6763 68 | Cover Plate + Support Frame - 12 Module - Pearl White | 794 | 5/25 |
| 6763 69 | Cover Plate + Support Frame - 18 Module - Pearl White | 1244 | 5/25 |

Myline™ Cover Plate

| Cat.Nos | Description | MRP* ₹ / Unit | Pack |
|---------|-------------|------------------|------|
|---------|-------------|------------------|------|

Champagne Cover Plates with Support Frame

| | | | |
|---------|---|------|--------|
| 6763 70 | Cover Plate + Support Frame - 1 Module - Champagne | 230 | 10/100 |
| 6763 71 | Cover Plate + Support Frame - 2 Module - Champagne | 230 | 10/100 |
| 6763 72 | Cover Plate + Support Frame - 3 Module - Champagne | 304 | 10/100 |
| 6763 73 | Cover Plate + Support Frame - 4 Module - Champagne | 332 | 10/100 |
| 6763 74 | Cover Plate + Support Frame - 6 Module - Champagne | 436 | 5/50 |
| 6763 75 | Cover Plate + Support Frame - 8 Module - Horizontal - Champagne | 550 | 5/50 |
| 6763 76 | Cover Plate + Support Frame - 2*4 Module - Vertical - Champagne | 562 | 5/25 |
| 6763 77 | Cover Plate + Support Frame - 9 Module - Champagne | 644 | 5/50 |
| 6763 78 | Cover Plate + Support Frame - 12 Module - Champagne | 794 | 5/25 |
| 6763 79 | Cover Plate + Support Frame - 18 Module - Champagne | 1244 | 5/25 |

Silver Alu Cover Plates with Support Frame

| | | | |
|---------|--|------|--------|
| 6763 80 | Cover Plate + Support Frame - 1 Module - Silver Alu | 230 | 10/100 |
| 6763 81 | Cover Plate + Support Frame - 2 Module - Silver Alu | 230 | 10/100 |
| 6763 82 | Cover Plate + Support Frame - 3 Module - Silver Alu | 304 | 10/100 |
| 6763 83 | Cover Plate + Support Frame - 4 Module - Silver Alu | 332 | 10/100 |
| 6763 84 | Cover Plate + Support Frame - 6 Module - Silver Alu | 436 | 5/50 |
| 6763 85 | Cover Plate + Support Frame - 8 Module - Horizontal - Silver Alu | 550 | 5/50 |
| 6763 86 | Cover Plate + Support Frame - 2*4 Module - Vertical - Silver Alu | 562 | 5/25 |
| 6763 87 | Cover Plate + Support Frame - 9 Module - Silver Alu | 644 | 5/50 |
| 6763 88 | Cover Plate + Support Frame - 12 Module - Silver Alu | 794 | 5/25 |
| 6763 89 | Cover Plate + Support Frame - 18 Module - Silver Alu | 1244 | 5/25 |

* MRP - Maximum Retail Price Inclusive of all taxes including GST.

Bold Cat.Nos are products normally available with Legrand (India) Stockists. Cat.Nos that are not bold - delivery within 4 - 8 weeks from the date of order. Bold packing quantity is our mandatory packing. Orders to be placed by Legrand (India) Stockist in multiples of the same.

Myline™ Cover Plate

| Cat.Nos | Description | MRP* ₹ / Unit | Pack |
|--|---|------------------|--------|
| Dark Bronze Cover Plates with Support Frame | | | |
| 6763 90 | Cover Plate + Support Frame - 1 Module - Dark Bronze | 230 | 10/100 |
| 6763 91 | Cover Plate + Support Frame - 2 Module - Dark Bronze | 230 | 10/100 |
| 6763 92 | Cover Plate + Support Frame - 3 Module - Dark Bronze | 304 | 10/100 |
| 6763 93 | Cover Plate + Support Frame - 4 Module - Dark Bronze | 332 | 10/100 |
| 6763 94 | Cover Plate + Support Frame - 6 Module - Dark Bronze | 436 | 5/50 |
| 6763 95 | Cover Plate + Support Frame - 8 Module - Horizontal - Dark Bronze | 550 | 5/50 |
| 6763 96 | Cover Plate + Support Frame - 2*4 Module - Vertical - Dark Bronze | 562 | 5/25 |
| 6763 97 | Cover Plate + Support Frame - 9 Module - Dark Bronze | 644 | 5/50 |
| 6763 98 | Cover Plate + Support Frame - 12 Module - Dark Bronze | 794 | 5/25 |
| 6763 99 | Cover Plate + Support Frame - 18 Module - Dark Bronze | 1244 | 5/25 |

Modular White Surrounds

| | | | |
|---------|--------------------------------------|-----|--------|
| 6755 81 | Modular Surrounds - 1 Module - White | 60 | 20/200 |
| 6755 82 | Modular Surrounds - 2 Module - White | 96 | 20/200 |
| 6755 83 | Modular Surrounds - 3 Module - White | 96 | 10/100 |
| 6755 84 | Modular Surrounds - 4 Module - White | 148 | 10/100 |
| 6755 86 | Modular Surrounds - 6 Module - White | 216 | 10/100 |
| 6755 89 | Modular Surrounds - 9 Module - White | 368 | 10/100 |

Myline™ Boxes

| Cat.Nos | Description | MRP* ₹ / Unit | Pack |
|--------------------------|--------------------------------|------------------|------|
| Accessories | | | |
| Metal Flush Boxes | | | |
| 6890 07 | Metal Flush Box - 1/2 Module | 170 | 40 |
| 6890 08 | Metal Flush Box - 3 Module | 170 | 40 |
| 6890 09 | Metal Flush Box - 4 Module | 226 | 40 |
| 6890 10 | Metal Flush Box - 6 Module | 358 | 40 |
| 6890 42 | Metal Flush Box - 8 Module | 416 | 40 |
| 6890 31 | Metal Flush Box - 2*4 Module | 414 | 20 |
| 6890 29 | Metal Flush Box - 9 Module | 490 | 20 |
| 6890 11 | Metal Flush Box - 12/16 Module | 624 | 10 |
| 6890 13 | Metal Flush Box - 16 Module | 720 | 10 |
| 6890 12 | Metal Flush Box - 18 Module | 788 | 10 |

Plastic Surface Boxes

| | | | |
|---------|----------------------------------|-----|-------|
| 6733 02 | Plastic Surface Box - 1/2 Module | 100 | 10/50 |
| 6733 03 | Plastic Surface Box - 3 Module | 114 | 5/35 |
| 6733 04 | Plastic Surface Box - 4 Module | 134 | 5/25 |
| 6733 06 | Plastic Surface Box - 6 Module | 172 | 1/10 |
| 6733 08 | Plastic Surface Box - 8 Module | 254 | 1/5 |
| 6733 05 | Plastic Surface Box - 2*4 Module | 240 | 1/5 |
| 6740 99 | Plastic Surface Box - 9 Module | 286 | 1/5 |

Metal Surface Boxes

| | | | |
|---------|--|-----|-----|
| 6890 21 | Metal Surface Box - 12 Module (2 Rows*6) | 600 | 1/6 |
| 6890 22 | Metal Surface Box - 18 Module (3 Rows*6) | 634 | 1/4 |

* MRP - Maximum Retail Price Inclusive of all taxes including GST.

Bold Cat.Nos are products normally available with Legrand (India) Stockists. Cat.Nos that are not bold - delivery within 4 - 8 weeks from the date of order. **Bold packing quantity** is our mandatory packing. Orders to be placed by Legrand (India) Stockist in multiples of the same.

MylinecTM

A little touch of genius

A LITTLE TOUCH OF GENIUS



Guarantee

- The Company, at its discretion, will replace products if they have any manufacturing defect within 10 years for switches (without LED lamp) and power sockets. For all other **MylinecTM** wiring accessories the guarantee will be 2 years.
- The above guarantee is applicable when the devices are used in Legrand metal flush boxes. Otherwise the guarantee period will be reduced by 50%.
- The guarantee is only applicable when the products are installed as per the Company's instructions and not tampered in any manner.
- The guarantee states the Company's entire liability. It does not extend to cover consequential loss or damage or installation costs arising from defective products.

Our switches are compliant with revised BIS standard (IS 3854:2023) requirements. Also, our switches are covered additionally for use on Self-Ballasted Lamp (SBL) loads.

SBL power rating as per IS3854:2023

| Switch Rating | 6A, 230V~ | 10A, 230V~ | 16A, 230V~ | 20A, 230V~ |
|------------------|-----------|------------|------------|------------|
| SBL power (Watt) | 100 W | 100 W | 200 W | 250 W |

LyncusTM

Upgrade to new

Elevate Your Home Experience



LyncusTM is a contemporary modular wiring range designed for modern homes. With minimalist styling and versatile modules for power, control, and connectivity, it delivers practical solutions for everyday electrical needs.

Features

- Smart aesthetics with a signature notch that defines modern minimalism
- Switch range from 6–32A with indicator options
- Universally adaptable modules covering lighting, sockets, BLDC Fan regulator, USB charging, data communication, hospitality, and more.
- High durability design rated for long operational life cycles

Benefits

- Ensures dependable performance with high-quality engineering and long-term reliability
- Enhances interiors with a sleek and contemporary design
- Simplifies installation with user-friendly, tool-free fitting
- Enables design customization with a range of premium colour finishes

Scan to know more about the product.



Lyncus^M

Upgrade to new

Upgrade Your Home



White



Brushed Silver



Alu Sunset



Champagne



Matt Silver



Usb Type C
- 20W PD
Fast Charging



USB Type A + C
- 15W



USB Type C + C
- 30W PD
Fast Charging



Remote Control Unit



Bluetooth Sound
Receiver



6/16A Socket
with Shutter (ISI)



Touch Fan
Regulator



Universal
Touch Dimmer



One Way
Touch Switch

Lyncus™

White Mechanism

| Cat.Nos | Description | MRP* ₹ / Unit | Pack |
|---------|-------------|------------------|------|
|---------|-------------|------------------|------|

Switches - 6A - 230V AC

| | | | |
|---------|---|-----|--------|
| 6772 00 | 6A - Switch - 1 Way - 1 Module | 98 | 20/200 |
| 6772 01 | 6A - Switch - 2 Way - 1 Module | 204 | 20/200 |
| 6772 02 | 6A - Switch - 1 Way - with Indicator - 1 Module | 204 | 20/200 |
| 6772 03 | 6A - Switch - 1 Way - with "Light" Marking - 1 Module | 184 | 20/200 |
| 6772 04 | 6A - Switch - 1 Way - with "Fan" Marking - 1 Module | 184 | 20/200 |

Switches - 10A - 230V AC

| | | | |
|---------|--|------|--------|
| 6773 01 | 10A - Switch - 1 Way - 1 Module | 106 | 20/200 |
| 6773 02 | 10A - Switch - 2 Way - 1 Module | 208 | 20/200 |
| 6773 07 | 10A - Switch - 1 Way - with Indicator - 1 Module | 208 | 20/200 |
| 6772 05 | 10A - Switch - 1 Way - 2 Module | 244 | 10/100 |
| 6772 06 | 10A - Switch - 2 Way - 2 Module | 292 | 10/100 |
| 6772 07 | 10A - Intermediate Switch - 2 Module | 1666 | 10/100 |
| 6772 08 | 10A - Switch - 1 Way - with Indicator - 2 Module | 320 | 10/100 |

Switches - 16A - 230V AC

| | | | |
|---------|--|-----|--------|
| 6772 09 | 16A - Switch - 1 Way - 1 Module | 236 | 20/200 |
| 6772 10 | 16A - Switch - 2 Way - 1 Module | 290 | 20/200 |
| 6772 11 | 16A - Switch - 1 Way - with Indicator - 1 Module | 300 | 20/200 |

Switches - 20A - 230V AC

| | | | |
|---------|---|-----|--------|
| 6772 12 | 20A - Switch - 1 Way - 1 Module | 346 | 20/200 |
| 6772 13 | 20A - Switch - DP - 1 Way - 2 Module | 502 | 10/100 |
| 6772 14 | 20A - Switch - DP - 1 Way - with Indicator - 2 Module | 512 | 10/100 |
| 6772 15 | 20A - Switch - 2 Way - 2 Module | 568 | 10/100 |

Switches - 25A - 230V AC

| | | | |
|---------|---|-----|--------|
| 6772 16 | 25A - Switch - SP - 1 Way - with Indicator - 1 Module | 358 | 20/200 |
|---------|---|-----|--------|

Switches - 32A - 230V AC

| | | | |
|---------|---|-----|--------|
| 6772 17 | 32A - Switch - DP - with Indicator - 2 Module | 690 | 10/100 |
|---------|---|-----|--------|

Push Button - 6A - 230V AC

| | | | |
|---------|---|-----|--------|
| 6772 18 | 6A - Push Button - SP - 1 Module | 168 | 20/200 |
| 6772 19 | 6A - Push Button - SP - with Indicator - 1 Module | 240 | 20/200 |
| 6772 20 | 6A - Bell Push - 1 Module | 216 | 20/200 |
| 6772 21 | 6A - Bell Push - with Indicator - 1 Module | 254 | 20/200 |
| 6772 22 | 6A - Bell Push - 2 Module | 290 | 10/100 |
| 6772 23 | 6A - Bell Push - with Indicator - 2 Module | 432 | 10/100 |

Accessory for Switch with Indicator

| | | | |
|---------|----------------------------|----|------|
| 6772 24 | LED Indicator for Switches | 54 | 5/50 |
|---------|----------------------------|----|------|

Lyncus™

White Mechanism

| Cat.Nos | Description | MRP* ₹ / Unit | Pack |
|---------|-------------|------------------|------|
|---------|-------------|------------------|------|

Indian Standard Sockets

| | | | |
|---------|---|-----|--------|
| 6772 35 | 6A - Socket - with Shutter - 3 Pin - ISI - 2 Module | 202 | 20/200 |
| 6772 30 | 6/16A - Socket - with Shutter - ISI - 2 Module | 410 | 10/100 |
| 6772 29 | 6/16A - Socket - with Shutter - ISI - 3 Module | 488 | 5/50 |
| 6772 26 | 16A - Switch + Socket - with Shutter - 3 Pin - 3 Module | 772 | 5/50 |

Dimmers & Fan Regulators

| | | | |
|---------|---|-----|----------|
| 6772 36 | Rotary Light Dimmer - 400 Watts - 1 Module | 742 | 5/50 |
| 6772 37 | Rotary Light Dimmer - 500 Watts - 2 Module | 952 | 10/100 |
| 6772 39 | Fan Regulator - 100 Watts - ISI - 1 Module | 680 | 5/50 |
| 6772 42 | Fan step Regulator - 70 Watts - ISI - 2 Module | 920 | 1/10/100 |
| 6772 40 | Fan Regulator - 100 Watts - 360° - ISI - 2 Module | 844 | 10/100 |
| 6772 41 | Fan Regulator - 120 Watts - 360° - ISI - 2 Module | 960 | 10/100 |
| 6772 44 | Fan Regulator - 8 Step - 100 Watts - ISI - 2 Module | 752 | 10/100 |
| 6772 45 | Fan Regulator - BLDC - 2 Module [^] | 924 | 10/100 |

Emergency Light

| | | | |
|---------|---|------|--------|
| 6772 43 | Emergency Removable LED Lamp - 2 Module | 3212 | 20/200 |
|---------|---|------|--------|

Skirting Light

| | | | |
|---------|--------------------------------------|-----|--------|
| 6772 48 | Skirting Light - with LED - 3 Module | 666 | 10/100 |
|---------|--------------------------------------|-----|--------|

Indicator

| | | | |
|---------|---|-----|--------|
| 6772 97 | Indicator Unit - with Transparent LED & Colored Labels - 1 Module | 470 | 10/100 |
|---------|---|-----|--------|

Bell Call Indicator

| | | | |
|---------|---------------------------------------|------|--------|
| 6772 49 | Bell Call Indicator - 240V - 1 Module | 1314 | 20/200 |
|---------|---------------------------------------|------|--------|

Buzzer

| | | | |
|---------|--------------------------|-----|--------|
| 6772 50 | Buzzer - 230V - 1 Module | 752 | 20/200 |
|---------|--------------------------|-----|--------|

Infrared Sensors

| | | | |
|---------|---|------|--------|
| 6772 51 | Infrared Sensor Switch - 400 Watts - 2 Module | 1714 | 20/200 |
|---------|---|------|--------|

Remote Unit

| | | | |
|---------|--|------|--------|
| 6772 52 | Remote Control Unit - for Light & Fan - 4 Module | 5218 | 1/5/20 |
| 6773 03 | Remote Control Hand Unit | 838 | 1/5/30 |

Hospitality Function

Hotel Keycard Switch

| | | | |
|---------|----------------------------------|------|--------|
| 6772 53 | 15A - Key Card Switch - 2 Module | 4150 | 1/10 |
| 6772 55 | Key Fob for Key Card Switch | 140 | 10/100 |

Hotel "DND and MMR" Functions

| | | | |
|---------|---|-----|--------|
| 6772 56 | External DND & MMR Control Unit - with Bell Push - 2 Module | 460 | 10/100 |
| 6772 57 | Internal DND & MMR Control Unit - 2 Module | 386 | 10/100 |

* MRP - Maximum Retail Price Inclusive of all taxes including GST.

[^] Compatible with Atomberg (Efficio), Havells (Efficiencia neo), Orient (Aerostorm) as per 2023 fan models.

Red Cat. Nos - New Products

Bold Cat.Nos are products normally available with Legrand (India) Stockists. Cat.Nos that are not bold - delivery within 4 - 8 weeks from the date of order. Bold packing quantity is our mandatory packing. Orders to be placed by Legrand (India) Stockist in multiples of the same.

Lyncus™

White Mechanism

| Cat.Nos | Description | MRP* ₹ / Unit | Pack |
|---------|-------------|------------------|------|
|---------|-------------|------------------|------|

Shaver socket

| | | | |
|---------|--|------|--------|
| 6772 58 | Shaver Socket - 120/240V - MonoBlock with Plate - 2 Module | 3182 | 20/200 |
|---------|--|------|--------|

Sockets & Connectors

Tv Sockets

| | | | |
|---------|---------------------------------|-----|--------|
| 6772 60 | TV Co - axial Socket - 1 Module | 230 | 20/200 |
|---------|---------------------------------|-----|--------|

Data & voice

| | | | |
|---------|--|-----|--------|
| 6772 62 | Telephone Socket - RJ11 - 1 Module | 216 | 20/200 |
| 6772 63 | Telephone Socket - Double RJ11 - 1 Module | 352 | 20/200 |
| 6772 64 | Information Socket - RJ45 - Cat 5 - UTP -with Shutter - 1 Module | 530 | 20/200 |
| 6772 65 | Information Socket - RJ45 - Cat 6 - UTP -with Shutter - 1 Module | 740 | 20/200 |
| 6773 20 | Information Socket - RJ45 - CAT6A - STP with shutter - 1 Module | 942 | 20/200 |

Audio Video Connectors

| | | | |
|---------|--|------|------|
| 6772 67 | Preterminated Audio/Video Connector - 1 Module | 1731 | 1/10 |
| 6772 68 | Preterminated HDMI Socket - 1 Module | 2121 | 1/10 |
| 6772 69 | Preterminated Projector Connector - 1 Module | 2121 | 1/10 |

Sound (Volume controller)

| | | | |
|---------|------------------------------|------|--------|
| 6772 70 | Volume Controller - 2 Module | 1361 | 10/100 |
|---------|------------------------------|------|--------|

Protectors and Accessories

Motor Starter

| | | | |
|---------|--------------------------------|-----|--------|
| 6772 71 | 16A - Motor Starter - 2 Module | 796 | 1/5/50 |
| 6772 72 | 25A - Motor Starter - 2 Module | 796 | 1/5/50 |

VSP

| | | | |
|---------|---|------|--------|
| 6772 74 | Voltage Surge Protector - 230V - 1 Module | 2654 | 20/200 |
|---------|---|------|--------|

Modular MCB (IS : 608981:2002)

| | | | |
|---------|-----------------------------------|-----|----------|
| 6772 81 | 16A - SP - Modular MCB - 1 Module | 546 | 1/10/100 |
| 6772 82 | 20A - SP - Modular MCB - 1 Module | 546 | 1/10/100 |
| 6772 83 | 32A - SP - Modular MCB - 1 Module | 546 | 1/10/100 |

Lyncus™

White Mechanism

| Cat.Nos | Description | MRP* ₹ / Unit | Pack |
|---------|-------------|------------------|------|
|---------|-------------|------------------|------|

Electronic Function

USB Chargers (IS13252 (Part 1) / IEC 60950-1)

| | | | |
|---------------------|---|------|----------|
| 6772 91 | USB Charger - 1500mA - Type A - 1 Module | 1356 | 10/100 |
| 6772 89 | USB Charger - 3000mA - Type A + C - 2 Module | 3028 | 1/10/100 |
| 6777 51 | USB Charger - 3000mA/15 Watts - Type A - 1 Module | 1986 | 1/5/50 |
| 6777 52 | USB Charger - 3000mA/15 Watts - Type A + A - 1 Module | 2206 | 1/5/50 |
| 6777 53 | USB Charger - 3000mA/15 Watts - Type A + C - 1 Module | 2526 | 1/5/50 |
| 6777 54 | USB Charger - 3000mA/15 Watts - Type C + C - 1 Module | 2762 | 1/5/50 |
| 6777 55 | USB Charger - Power Delivery - 20 Watts - Type C - 1 Module | 3824 | 1/5/50 |
| 6777 56 | USB Charger - Power Delivery - 30 Watts - Type C + C - 2 Module | 6562 | 1/3/30 |
| 6777 57 | USB Charger - Power Delivery - 45W - Type C - 2 Module | 8034 | 1/3/30 |
| NEW! 6777 59 | USB Charger - Power Delivery - 65W - Type C + C - 3 Module | 9966 | 1/5/20 |

Loud Speakers

| | | | |
|---------|--|------|-----|
| 6772 98 | Loudspeaker for False Ceiling & Plaster Board - 8Ohms - 10 Watts | 2741 | 1/6 |
|---------|--|------|-----|

Sound Diffusion

| | | | |
|----------|--------------------------------------|------|----------|
| 6772 99* | Bluetooth Sound Diffusion - 2 Module | 6033 | 1/10/100 |
|----------|--------------------------------------|------|----------|

Rotary Dimmer Universal

| | | | |
|---------|---|------|----------|
| 6773 04 | Rotary LED Light Dimmer - 50 Watts - 1 Module | 2740 | 1/10/100 |
|---------|---|------|----------|

Touch Switches

| | | | |
|---------|---|------|------|
| 6773 09 | 6A - Touch Switch - 1 Way - 2 Module - Black | 3782 | 1/50 |
| 6773 10 | 6A - Touch Switch - 2 Way - 2 Module - Black | 4370 | 1/50 |
| 6773 13 | 16A - Touch Switch - 1 Way - 2 Module - Black | 4370 | 1/50 |
| 6773 06 | 6A - Touch Bell Push - 2 Module - Black | 3782 | 1/50 |

Touch Regulator & Dimmer

| | | | |
|---------|---|------|------|
| 6773 05 | Touch Fan Regulator - 100 Watts - 2 Module - Black | 4370 | 1/50 |
| 6773 15 | Universal LED Touch Light Scroll Dimming - 300 Watts - 2 Module - Black | 4370 | 1/50 |

Reading Light

| | | | |
|---------|-------------------|------|--------|
| 6773 16 | Reading Light LED | 2524 | 20/200 |
|---------|-------------------|------|--------|

* MRP - Maximum Retail Price Inclusive of all taxes including GST.
Red Cat. Nos - New Products

Bold Cat.Nos are products normally available with Legrand (India) Stockists. Cat.Nos that are not bold - delivery within 4 - 8 weeks from the date of order. Bold packing quantity is our mandatory packing. Orders to be placed by Legrand (India) Stockist in multiples of the same.

Lyncus™

White Mechanism

| Cat.Nos | Description | MRP* ₹ / Unit | Pack |
|---------|-------------|------------------|------|
|---------|-------------|------------------|------|

Accessories

| | | | |
|---------|---|-----|--------|
| 6772 75 | Cable Outlet - 8mm - 1 Module | 208 | 20/200 |
| 6772 76 | Blanking Plate - 1 Module - Classic White | 54 | 40/400 |
| 6772 77 | Blanking Plate - 2 Module - Classic White | 70 | 10/100 |

Chic Grey- Mechanism

Switches - 6A - 230V AC

| | | | |
|---------|---|-----|--------|
| 6774 00 | 6A - Switch - 1 Way - 1 Module | 118 | 20/200 |
| 6774 01 | 6A - Switch - 2 Way - 1 Module | 236 | 20/200 |
| 6774 02 | 6A - Switch - 1 Way - with Indicator - 1 Module | 238 | 20/200 |
| 6774 03 | 6A - Switch - 1 Way - with "Light" Marking - 1 Module | 226 | 20/200 |
| 6774 04 | 6A - Switch - 1 Way - with "Fan" Marking - 1 Module | 226 | 20/200 |

Switches - 10A - 230V AC

| | | | |
|---------|--|------|--------|
| 6774 05 | 10A - Switch - 1 Way - 2 Module | 288 | 10/100 |
| 6774 06 | 10A - Switch - 2 Way - 2 Module | 338 | 10/100 |
| 6774 07 | 10A - Intermediate Switch - 2 Module | 1918 | 10/100 |
| 6774 08 | 10A - Switch - 1 Way - with Indicator - 2 Module | 372 | 10/100 |

Switches - 16A - 230V AC

| | | | |
|---------|--|-----|--------|
| 6774 09 | 16A - Switch - 1 Way - 1 Module | 260 | 20/200 |
| 6774 10 | 16A - Switch - 2 Way - 1 Module | 334 | 20/200 |
| 6774 11 | 16A - Switch - 1 Way - with Indicator - 1 Module | 346 | 20/200 |

Switches - 20A - 230V AC

| | | | |
|---------|---|-----|--------|
| 6774 12 | 20A - Switch - 1 Way - 1 Module | 402 | 20/200 |
| 6774 13 | 20A - Switch - DP - 1 Way - 2 Module | 580 | 10/100 |
| 6774 14 | 20A - Switch - DP - 1 Way - with Indicator - 2 Module | 588 | 10/100 |
| 6774 15 | 20A - Switch - 2 Way - 2 Module | 666 | 10/100 |

Switches - 25A - 230V AC

| | | | |
|---------|---|-----|--------|
| 6774 16 | 25A - Switch - SP - 1 Way - with Indicator - 1 Module | 414 | 20/200 |
|---------|---|-----|--------|

Switches - 32A - 230V AC

| | | | |
|---------|---|-----|--------|
| 6774 17 | 32A - Switch - DP - with Indicator - 2 Module | 794 | 10/100 |
|---------|---|-----|--------|

Push Button - 6A - 230V AC

| | | | |
|---------|---|-----|--------|
| 6774 18 | 6A - Push Button - SP - 1 Module | 192 | 20/200 |
| 6774 19 | 6A - Push Button - SP - with Indicator - 1 Module | 272 | 20/200 |
| 6774 20 | 6A - Bell Push - 1 Module | 250 | 20/200 |
| 6774 21 | 6A - Bell Push - with Indicator - 1 Module | 296 | 20/200 |
| 6774 22 | 6A - Bell Push - 2 Module | 334 | 10/100 |
| 6774 23 | 6A - Bell Push - with Indicator - 2 Module | 494 | 10/100 |

Lyncus™

Chic Grey Mechanism

| Cat.Nos | Description | MRP* ₹ / Unit | Pack |
|---------|-------------|------------------|------|
|---------|-------------|------------------|------|

Indian Standard Sockets

| | | | |
|---------|---|-----|--------|
| 6774 35 | 6A - Socket - with Shutter - 3 Pin - ISI - 2 Module | 232 | 20/200 |
| 6774 30 | 6/16A - Socket - with Shutter - ISI - 2 Module | 474 | 10/100 |
| 6774 29 | 6/16A - Socket - with Shutter - ISI - 3 Module | 564 | 5/50 |

Dimmers & Fan Regulators

| | | | |
|---------|---|------|----------|
| 6774 36 | Rotary Light Dimmer - 400 Watts - 1 Module | 854 | 5/50 |
| 6774 37 | Rotary Light Dimmer - 500 Watts - 2 Module | 1090 | 10/100 |
| 6774 39 | Fan Regulator - 100 Watts - ISI - 1 Module | 788 | 5/50 |
| 6774 42 | Fan step Regulator - 70 Watts - ISI - 2 Module | 1060 | 1/10/100 |
| 6774 40 | Fan Regulator - 100 Watts - 360° - ISI - 2 Module | 970 | 10/100 |
| 6774 41 | Fan Regulator - 120 Watts - 360° - ISI - 2 Module | 1102 | 10/100 |
| 6774 44 | Fan Regulator - 8 Step - 100 Watts - ISI - 2 Module | 880 | 10/100 |
| 6774 45 | Fan Regulator - BLDC - 2 Module^ | 1070 | 10/100 |

Skirting Light

| | | | |
|---------|--------------------------------------|-----|--------|
| 6774 48 | Skirting Light - with LED - 3 Module | 752 | 10/100 |
|---------|--------------------------------------|-----|--------|

Bell Call Indicator

| | | | |
|---------|---------------------------------------|------|--------|
| 6774 49 | Bell Call Indicator - 240V - 1 Module | 1482 | 20/200 |
|---------|---------------------------------------|------|--------|

Buzzer

| | | | |
|---------|--------------------------|-----|--------|
| 6774 50 | Buzzer - 230V - 1 Module | 854 | 20/200 |
|---------|--------------------------|-----|--------|

Remote Unit

| | | | |
|---------|--|------|--------|
| 6774 52 | Remote Control Unit - for Light & Fan - 4 Module | 5602 | 1/5/20 |
| 6773 03 | Remote Control Hand Unit | 838 | 1/5/30 |

Hospitality Function

Hotel Keycard Switch

| | | | |
|---------|----------------------------------|------|--------|
| 6774 53 | 15A - Key Card Switch - 2 Module | 4682 | 1/10 |
| 6772 55 | Key Fob for Key Card Switch | 140 | 10/100 |

Hotel "DND and MMR" Functions

| | | | |
|---------|---|-----|--------|
| 6774 56 | External DND & MMR Control Unit - with Bell Push - 2 Module | 528 | 10/100 |
| 6774 57 | Internal DND & MMR Control Unit - 2 Module | 460 | 10/100 |

Shaver Socket

| | | | |
|---------|--|------|--------|
| 6774 58 | Shaver Socket - 120/240V - MonoBlock with Plate - 2 Module | 3560 | 20/200 |
|---------|--|------|--------|

TV Sockets

| | | | |
|---------|---------------------------------|-----|--------|
| 6774 60 | TV Co - axial Socket - 1 Module | 262 | 20/200 |
|---------|---------------------------------|-----|--------|

* MRP - Maximum Retail Price Inclusive of all taxes including GST.

^Compatible with Atomberg (Efficio), Havells (Eficiencia neo), Orient (Aerostorm) as per 2023 fan models.

Bold Cat.Nos are products normally available with Legrand (India) Stockists. Cat.Nos that are not bold - delivery within 4 - 8 weeks from the date of order. Bold packing quantity is our mandatory packing. Orders to be placed by Legrand (India) Stockist in multiples of the same.

Lyncus™

Chic Grey Mechanism

| Cat.Nos | Description | MRP* ₹ / Unit | Pack |
|---------|-------------|------------------|------|
|---------|-------------|------------------|------|

Data & Voice

| | | | |
|---------|--|------|--------|
| 6774 62 | Telephone Socket - RJ11 - 1 Module | 246 | 20/200 |
| 6774 63 | Telephone Socket - Double RJ11 - 1 Module | 416 | 20/200 |
| 6774 64 | Information Socket - RJ45 - Cat 5 - UTP -with Shutter - 1 Module | 580 | 20/200 |
| 6774 65 | Information Socket - RJ45 - Cat 6 - UTP -with Shutter - 1 Module | 892 | 20/200 |
| 6773 21 | Information Socket - RJ45 - CAT6A - STP with shutter - 1 Module | 1023 | 20/200 |

Audio Video Sockets

| | | | |
|---------|--|------|------|
| 6774 67 | Preterminated Audio/Video Connector - 1 Module | 1994 | 1/10 |
| 6774 68 | Preterminated HDMI Socket - 1 Module | 2438 | 1/10 |
| 6774 69 | Preterminated Projector Connector - 1 Module | 2438 | 1/10 |

Sound (volume controller)

| | | | |
|---------|------------------------------|------|----------|
| 6774 70 | Volume Controller - 2 Module | 1572 | 1/10/100 |
|---------|------------------------------|------|----------|

Electronic Function

USB Chargers (IS13252 (Part 1) / IEC 609501)

| | | | |
|---------------------|---|-------|----------|
| 6774 91 | USB Charger - 1500mA - Type A - 1 Module | 1540 | 1/5/50 |
| 6774 89 | USB Charger - 3000mA - Type A + C - 2 Module | 3480 | 1/10/100 |
| 6779 51 | USB Charger - 3000mA/15 Watts - Type A - 1 Module | 2214 | 1/5/50 |
| 6779 52 | USB Charger - 3000mA/15 Watts - Type A + A - 1 Module | 2480 | 1/5/50 |
| 6779 53 | USB Charger - 3000mA/15 Watts - Type A + C - 1 Module | 2808 | 1/5/50 |
| 6779 54 | USB Charger - 3000mA/15 Watts - Type C + C - 1 Module | 3066 | 1/5/50 |
| 6779 55 | USB Charger - Power Delivery - 20 Watts - Type C - 1 Module | 4276 | 1/5/50 |
| 6779 56 | USB Charger - Power Delivery - 30 Watts - Type C + C - 2 Module | 7188 | 1/3/30 |
| 6779 57 | USB Charger - Power Delivery - 45W - Type C - 2 Module | 8856 | 1/3/30 |
| NEW! 6779 59 | USB Charger - Power Delivery - 65W - Type C + C - 3 Module | 10526 | 1/5/20 |

Sound Receiver

| | | | |
|----------|--------------------------------------|------|----------|
| 6774 99* | Bluetooth Sound Diffusion - 2 Module | 6941 | 1/10/100 |
|----------|--------------------------------------|------|----------|

Rotary Dimmer Universal

| | | | |
|---------|---|------|-------|
| 6774 24 | Rotary LED Dimmer - 50 Watts - 1 Module | 3474 | 1/120 |
|---------|---|------|-------|

Accessories

| | | | |
|---------|-------------------------------|-----|--------|
| 6774 75 | Cable Outlet - 8mm - 1 Module | 246 | 20/200 |
| 6774 76 | Blanking Plate - 1 Module | 58 | 40/400 |

Lyncus™

Plate with Support Frame

| Cat.Nos | Description | MRP* ₹ / Unit | Pack |
|---------|-------------|------------------|------|
|---------|-------------|------------------|------|

Cover Plates with Support Frame White Cover Plates with Support Frame



| | | | |
|---------|---|-----|--------|
| 6775 01 | Cover Plate + Support Frame - 1 Module - Classic White | 170 | 20/200 |
| 6775 02 | Cover Plate + Support Frame - 2 Module - Classic White | 170 | 20/200 |
| 6775 03 | Cover Plate + Support Frame - 3 Module - Classic White | 218 | 10/100 |
| 6775 04 | Cover Plate + Support Frame - 4 Module - Classic White | 254 | 10/100 |
| 6775 06 | Cover Plate + Support Frame - 6 Module - Classic White | 308 | 5/50 |
| 6775 08 | Cover Plate + Support Frame - 8 Module - Horizontal - Classic White | 394 | 5/50 |
| 6775 09 | Cover Plate + Support Frame - 2*4 Module - Vertical - Classic White | 412 | 5/25 |
| 6775 10 | Cover Plate + Support Frame - 9 Module - Classic White | 438 | 5/50 |
| 6775 12 | Cover Plate + Support Frame - 12 Module - Classic White | 574 | 10 |
| 6775 16 | Cover Plate + Support Frame - 16 Module - Classic White | 668 | 10 |
| 6776 17 | Cover Plate + Support Frame - 16 Module(Big) - Classic White | 680 | 10 |
| 6775 18 | Cover Plate + Support Frame - 18 Module - Classic White | 902 | 10 |

* MRP - Maximum Retail Price Inclusive of all taxes including GST.
Red Cat. Nos - New Products

Bold Cat.Nos are products normally available with Legrand (India) Stockists. Cat.Nos that are not bold - delivery within 4 - 8 weeks from the date of order. Bold packing quantity is our mandatory packing. Orders to be placed by Legrand (India) Stockist in multiples of the same.

Lyncus™



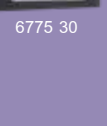
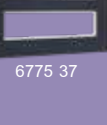
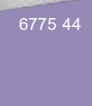
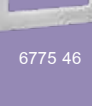

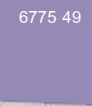





Plate with Support Frame

| Cat.Nos | Description | MRP* ₹ / Unit | Pack |
|--|---|---------------------|--------|
| Chic Grey Cover Plates with Support Frame | | | |
|  6775 21 | Cover Plate + Support Frame - 1 Module - Chic Grey | 218 | 20/200 |
|  6775 22 | Cover Plate + Support Frame - 2 Module - Chic Grey | 218 | 20/200 |
|  6775 23 | Cover Plate + Support Frame - 3 Module - Chic Grey | 304 | 10/100 |
|  6775 24 | Cover Plate + Support Frame - 4 Module - Chic Grey | 322 | 10/100 |
|  6775 26 | Cover Plate + Support Frame - 6 Module - Chic Grey | 396 | 5/50 |
|  6775 28 | Cover Plate + Support Frame - 8 Module - Horizontal - Chic Grey | 540 | 5/50 |
|  6775 29 | Cover Plate + Support Frame - 2*4 Module - Vertical - Chic Grey | 540 | 5/25 |
|  6775 30 | Cover Plate + Support Frame - 9 Module - Chic Grey | 582 | 5/50 |
|  6775 32 | Cover Plate + Support Frame - 12 Module - Chic Grey | 754 | 10 |
|  6775 36 | Cover Plate + Support Frame - 16 Module - Chic Grey | 868 | 10 |
| 6776 37 | Cover Plate + Support Frame - 16 Module (Big) - Chic Grey | 874 | 10 |
| 6775 38 | Cover Plate + Support Frame - 18 Module - Chic Grey | 1184 | 10 |

* MRP - Maximum Retail Price Inclusive of all taxes including GST.

Lyncus™

Plate with Support Frame

| Cat.Nos | Description | MRP* ₹ / Unit | Pack |
|--|--|---------------------|--------|
| Brushed Silver Cover Plates with Support Frame | | | |
|  6775 41 | Cover Plate + Support Frame - 1 Module - Brushed Silver | 224 | 20/200 |
|  6775 42 | Cover Plate + Support Frame - 2 Module - Brushed Silver | 224 | 20/200 |
|  6775 43 | Cover Plate + Support Frame - 3 Module - Brushed Silver | 322 | 10/100 |
|  6775 44 | Cover Plate + Support Frame - 4 Module - Brushed Silver | 332 | 10/100 |
|  6775 46 | Cover Plate + Support Frame - 6 Module - Brushed Silver | 426 | 5/50 |
|  6775 48 | Cover Plate + Support Frame - 8 Module - Horizontal - Brushed Silver | 552 | 5/50 |
|  6775 49 | Cover Plate + Support Frame - 2*4 Module - Vertical - Brushed Silver | 552 | 5/25 |
|  6775 50 | Cover Plate + Support Frame - 9 Module - Brushed Silver | 606 | 5/50 |
|  6775 52 | Cover Plate + Support Frame - 12 Module - Brushed Silver | 790 | 10 |
|  6775 56 | Cover Plate + Support Frame - 16 Module - Brushed Silver | 914 | 10 |
|  6776 57 | Cover Plate + Support Frame - 16 Module (Big) - Brushed Silver | 926 | 10 |
|  6775 58 | Cover Plate + Support Frame - 18 Module - Brushed Silver | 1244 | 10 |

Bold Cat.Nos are products normally available with Legrand (India) Stockists. Cat.Nos that are not bold - delivery within 4 - 8 weeks from the date of order. Bold packing quantity is our mandatory packing. Orders to be placed by Legrand (India) Stockist in multiples of the same.

Lyncus™







Plate with Support Frame

| Cat.Nos | Description | MRP* ₹ / Unit | Pack |
|---|--|---------------------|--------|
|  6775 61 | Cover Plate + Support Frame - 1 Module - Alu SunSet | 220 | 20/200 |
|  6775 62 | Cover Plate + Support Frame - 2 Module - Alu SunSet | 220 | 20/200 |
|  6775 63 | Cover Plate + Support Frame - 3 Module - Alu SunSet | 304 | 10/100 |
|  6775 64 | Cover Plate + Support Frame - 4 Module - Alu SunSet | 330 | 10/100 |
|  6775 66 | Cover Plate + Support Frame - 6 Module - Alu SunSet | 418 | 5/50 |
|  6775 68 | Cover Plate + Support Frame - 8 Module - Horizontal - Alu SunSet | 540 | 5/50 |
|  6775 69 | Cover Plate + Support Frame - 2*4 Module - Vertical - Alu SunSet | 544 | 5/25 |
|  6775 70 | Cover Plate + Support Frame - 9 Module - Alu SunSet | 582 | 5/50 |
|  6775 72 | Cover Plate + Support Frame - 12 Module - Alu SunSet | 768 | 10 |
| 6775 76 | Cover Plate + Support Frame - 16 Module - Alu SunSet | 888 | 10 |
| 6776 77 | Cover Plate + Support Frame - 16 Module(Big) - Alu SunSet | 894 | 10 |
| 6775 78 | Cover Plate + Support Frame - 18 Module - Alu SunSet | 1220 | 10 |

* MRP - Maximum Retail Price Inclusive of all taxes including GST.

Lyncus™

Plate with Support Frame

| Cat.Nos | Description | MRP* ₹ / Unit | Pack |
|---|---|---------------------|--------|
|  6775 81 | Cover Plate + Support Frame - 1 Module - Champagne | 220 | 20/200 |
|  6775 82 | Cover Plate + Support Frame - 2 Module - Champagne | 220 | 20/200 |
|  6775 83 | Cover Plate + Support Frame - 3 Module - Champagne | 304 | 10/100 |
|  6775 84 | Cover Plate + Support Frame - 4 Module - Champagne | 330 | 10/100 |
|  6775 86 | Cover Plate + Support Frame - 6 Module - Champagne | 418 | 5/50 |
|  6775 88 | Cover Plate + Support Frame - 8 Module - Horizontal - Champagne | 540 | 5/50 |
|  6775 89 | Cover Plate + Support Frame - 2*4 Module - Vertical - Champagne | 544 | 5/25 |
|  6775 90 | Cover Plate + Support Frame - 9 Module - Champagne | 582 | 5/50 |
|  6775 92 | Cover Plate + Support Frame - 12 Module - Champagne | 768 | 10 |
|  6775 96 | Cover Plate + Support Frame - 16 Module - Champagne | 888 | 10 |
| 6776 97 | Cover Plate + Support Frame - 16 Module(Big) - Champagne | 894 | 10 |
| 6775 98 | Cover Plate + Support Frame - 18 Module - Champagne | 1220 | 10 |

Bold Cat.Nos are products normally available with Legrand (India) Stockists. Cat.Nos that are not bold - delivery within 4 - 8 weeks from the date of order. Bold packing quantity is our mandatory packing. Orders to be placed by Legrand (India) Stockist in multiples of the same.

Lyncus™

Plate with Support Frame

| Cat.Nos | Description | MRP* ₹ / Unit | Pack |
|--|---|------------------|--------|
| Matt Silver Cover Plates with Support Frame | | | |
| 6776 01 | Cover Plate + Support Frame - 1 Module - Matt Silver | 220 | 20/200 |
| 6776 02 | Cover Plate + Support Frame - 2 Module - Matt Silver | 220 | 20/200 |
| 6776 03 | Cover Plate + Support Frame - 3 Module - Matt Silver | 304 | 10/100 |
| 6776 04 | Cover Plate + Support Frame - 4 Module - Matt Silver | 330 | 10/100 |
| 6776 06 | Cover Plate + Support Frame - 6 Module - Matt Silver | 418 | 5/50 |
| 6776 08 | Cover Plate + Support Frame - 8 Module - Horizontal - Matt Silver | 540 | 5/50 |
| 6776 09 | Cover Plate + Support Frame - 2*4 Module - Vertical - Matt Silver | 544 | 5/25 |
| 6776 10 | Cover Plate + Support Frame - 9 Module - Matt Silver | 582 | 5/50 |
| 6776 12 | Cover Plate + Support Frame - 12 Module - Matt Silver | 768 | 10 |
| 6776 16 | Cover Plate + Support Frame - 16 Module - Matt Silver | 888 | 10 |
| 6776 67 | Cover Plate + Support Frame - 16 Module(Big) - Matt Silver | 894 | 10 |
| 6776 18 | Cover Plate + Support Frame - 18 Module - Matt Silver | 1220 | 10 |

Accessories

Metal Flush Boxes

| | | | |
|---------|--------------------------------|-----|----|
| 6890 07 | Metal Flush Box - 1/2 Module | 170 | 40 |
| 6890 08 | Metal Flush Box - 3 Module | 170 | 40 |
| 6890 09 | Metal Flush Box - 4 Module | 226 | 40 |
| 6890 10 | Metal Flush Box - 6 Module | 358 | 40 |
| 6890 42 | Metal Flush Box - 8 Module | 416 | 40 |
| 6890 31 | Metal Flush Box - 2*4 Module | 414 | 20 |
| 6890 29 | Metal Flush Box - 9 Module | 490 | 20 |
| 6890 11 | Metal Flush Box - 12/16 Module | 624 | 10 |
| 6890 13 | Metal Flush Box - 16 Module | 720 | 10 |
| 6890 12 | Metal Flush Box - 18 Module | 788 | 10 |

* MRP - Maximum Retail Price Inclusive of all taxes including GST.

Lyncus™

Boxes

| Cat.Nos | Description | MRP* ₹ / Unit | Pack |
|---------|-------------|------------------|------|
|---------|-------------|------------------|------|

Plastic Surface Boxes

| | | | |
|---------|----------------------------------|-----|-------|
| 6733 02 | Plastic Surface Box - 1/2 Module | 100 | 10/50 |
| 6733 03 | Plastic Surface Box - 3 Module | 114 | 5/35 |
| 6733 04 | Plastic Surface Box - 4 Module | 134 | 5/25 |
| 6733 06 | Plastic Surface Box - 6 Module | 172 | 1/10 |
| 6733 08 | Plastic Surface Box - 8 Module | 254 | 1/5 |
| 6733 05 | Plastic Surface Box - 2*4 Module | 240 | 1/5 |
| 6740 99 | Plastic Surface Box - 9 Module | 286 | 1/5 |

Metal Surface Boxes

| | | | |
|---------|--|-----|-----|
| 6890 21 | Metal Surface Box - 12 Module (2 Rows*6) | 600 | 1/6 |
| 6890 22 | Metal Surface Box - 18 Module (3 Rows*6) | 634 | 1/4 |

LyncusTM

Change to today

Guarantee

- The Company, at its discretion, will replace products if they have any manufacturing defect within 10 years for switches (without LED lamp) and power sockets. For all other **LyncusTM** wiring accessories the guarantee will be 2 years.
- The above guarantee is applicable when the devices are used in Legrand metal flush boxes. Otherwise the guarantee period will be reduced by 50%.
- The guarantee is only applicable when the products are installed as per the Company's instructions and not tampered in any manner.
- The guarantee states the Company's entire liability. It does not extend to cover consequential loss or damage or installation costs arising from defective products.

Our switches are compliant with revised BIS standard (IS 3854:2023 requirements). Also, our switches are covered additionally for use on Self-Ballasted Lamp (SBL) loads.

SBL power rating as per IS3854:2023

| Switch Rating | 6A, 230V~ | 10A, 230V~ | 16A, 230V~ | 20A, 230V~ |
|------------------|-----------|------------|------------|------------|
| SBL power (Watt) | 100 W | 100 W | 200 W | 250 W |

Allzy™

The All-Rounder Switch Range



Allzy™ is a versatile modular switch range designed for modern Indian homes and workplaces. Combining stylish finishes, versatile modules, and dependable performance, it delivers convenient solutions for power, charging, connectivity, and everyday control.

Features

- Durable switch mechanisms tested for 1 lakh on/off operations
- Comprehensive switch range upto 32A rating with low-noise rockers, regulators and dimmers
- 6A, 6/16A sockets shuttered also offering complete USB charging needs for everyday usage
- Connectivity modules RJ11, RJ45, HDMI, AV and projector sockets
- Convenience & hospitality controls such as remote control units, switches, and MMR modules

Benefits

- Enhances interiors with five stylish plate finishes and dual mechanism colours
- Ensures dependable safety with shuttered sockets, certified components, and durable performance testing
- Enables seamless connectivity for communication, entertainment, and presentations
- Improves convenience through rapid USB charging solutions



Colour Plates:



Scan to know more about the product.



Allzy

The All-rounder Switch

Live the Advantage
of an All-Rounder.

Range

SWITCHES



6A Switch 1W-
Light Marking



6A Switch 1W-
Fan Marking



20A DP Switch 1W-
Indicator Marking



6A Bell Push 1W-
Indicator Marking



Gold- Plate & Frame



Aluminium Champagne-
Plate & Frame



Rose Gold-Plate & Frame



White-Plate & Frame



Matt Black-Plate & Frame

SOCKETS

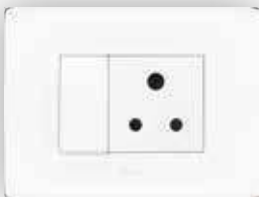

6A 3 Pin Socket with Shutter
- ISI Mark



6/16A Socket with shutter
- ISI Mark

ELECTRONICS



Fan Regulator 8 step 100W
- ISI Mark



Fan Regulator 360° 100W
- ISI Mark



Rotary Dimmer 500W



Remote Control Unit

USB



Type A + C
3A, 1M



Type A + C 3A, 2M



Type C 20W PD, 1M



Type C + C 30W PD,
2M



Type C 45W PD, 2M*



Type C + C 65W PD, 3M*

*45 & 65W COMPATIBLE FOR LAPTOP CHARGING

VOICE & DATA COMMUNICATIONS



Double RJ11 Telephone
Socket (with Shutter)



RJ11 Telephone Socket
(with Shutter)



RJ45 Cat6 UTP Socket
(with Shutter)

AUDIO VIDEO CONNECTOR



Preterminated
Audio Video Connector



Preterminated
HDMI Socket

PROTECTION



Power Unit with 20A MCB &
16A Plug



32A Modular MCB DP



16A Motor starter

HOSPITALITY



Key card 15A switch-
Card 230V



32A DP Key tag switch
(Mechanical)



Shaver Socket 120/230V
AC with plate



DND & MMR indicator-
6A bell push (Outside)



DND & MMR (Inside)

White - Mechanism

| Cat.Nos | Description | MRP* ₹ / Unit | Pack |
|---------|-------------|------------------|------|
|---------|-------------|------------------|------|

Switches 6A - 230V AC

| | | | |
|---------|--|-----|--------|
| 6811 00 | 6A - Switch - SP - 1 Way - 1 Module | 54 | 20/400 |
| 6811 11 | 6A - Switch - SP - 2 Way - 1 Module | 122 | 20/200 |
| 6811 02 | 6A - Switch - SP - 1 Way - with Indicator - 1 Module | 108 | 20/200 |
| 6811 03 | 6A - Switch - SP - 1 Way - with "Light" Marking - 1 Module | 110 | 20/200 |
| 6811 04 | 6A - Switch - SP - 1 Way - with "Fan" Marking - 1 Module | 110 | 20/200 |

Switches - 10A - 230V AC

| | | | |
|---------|--|-----|--------|
| 6811 74 | 10A - Switch - 1 Way - 1 Module | 58 | 20/200 |
| 6811 75 | 10A - Switch - 2 Way - 1 Module | 124 | 20/200 |
| 6811 76 | 10A - Switch - 1 Way - with Indicator - 1 Module | 108 | 20/200 |

Switches - 16A - 230V AC

| | | | |
|---------|---|-----|--------|
| 6811 01 | 16A - Switch - SP - 1 Way - 1 Module | 146 | 20/200 |
| 6811 12 | 16A - Switch - SP - 2 Way - 1 Module | 212 | 20/200 |
| 6811 05 | 16A - Switch - SP - 1 Way - with Indicator - 1 Module | 190 | 20/200 |

Switches - 20A - 230V AC

| | | | |
|---------|---|-----|--------|
| 6811 07 | 20A - Switch - SP - 1 Way - 1 Module | 174 | 20/200 |
| 6811 08 | 20A - Switch - SP - 1 Way - with Indicator - 1 Module | 230 | 20/200 |
| 6811 13 | 20A - Switch - SP - 1 Way - with Indicator - 2 Module | 262 | 10/100 |
| 6811 15 | 20A - Switch - DP - 1 Way - with Indicator - 2 Module | 268 | 10/100 |

Switches - 25A - 230V AC

| | | | |
|---------|---|-----|--------|
| 6811 06 | 25A - Switch - SP - 1 Way - with Indicator - 1 Module | 244 | 20/200 |
|---------|---|-----|--------|

Switches - 32A - 230V AC

| | | | |
|---------|---|-----|--------|
| 6811 16 | 32A - Switch - DP - 1 Way - with Indicator - 2 Module | 356 | 10/100 |
|---------|---|-----|--------|

Push Button - 6A - 230V AC

| | | | |
|---------|---|-----|--------|
| 6811 09 | 6A - Bell Push - SP - 1 Way - 1 Module | 120 | 20/200 |
| 6811 10 | 6A - Bell Push - SP - 1 Way - with Indicator - 1 Module | 146 | 20/200 |
| 6811 14 | 6A - Bell Push - SP - 1 Way - with Indicator - 2 Module | 222 | 10/100 |

Accessory for Switch with Indicator

| | | | |
|---------|--------------------------------|----|--------|
| 6811 37 | LED Indicator for Switch (Red) | 50 | 1/5/50 |
|---------|--------------------------------|----|--------|

Indian Standard Sockets

| | | | |
|---------|---|-----|--------|
| 6811 24 | 6A - Socket - with Shutter - 3 Pin - ISI - 2 Module | 188 | 20/200 |
| 6811 22 | 6/16A - Socket - with Shutter - ISI - 2 Module | 270 | 10/100 |

* MRP - Maximum Retail Price Inclusive of all taxes including GST.
 ^Compatible with Atomberg (Efficio), Havells (Efficiencia neo), Orient (Aerostorm) as per 2023 fan models.

White - Mechanism

| Cat.Nos | Description | MRP* ₹ / Unit | Pack |
|---------|-------------|------------------|------|
|---------|-------------|------------------|------|

Dimmers & Fan Regulators

| | | | |
|---------|---|-----|----------|
| 6811 43 | Rotary Dimmer - 400 Watts - 1 Module | 578 | 5/50 |
| 6811 44 | Rotary Dimmer - 500 Watts - 2 Module | 752 | 10/100 |
| 6811 40 | Fan Regulator - 4 Step - 100 Watts - ISI - 1 Module | 570 | 5/50 |
| 6811 41 | Fan Regulator - 100 Watts - with 360° Rotation - ISI - 2 Module | 658 | 10/100 |
| 6811 42 | Fan Regulator - 8 Step - 100 Watts - ISI - 2 Module | 718 | 1/10/100 |
| 6811 99 | Fan Regulator - BLDC - 2 Module^ | 670 | 1/10/100 |

Skirting Light

| | | | |
|---------|---------------------------|-----|-------|
| 6811 50 | Skirting Light - 2 Module | 470 | 10/50 |
|---------|---------------------------|-----|-------|

Indicator

| | | | |
|---------|-------------------------------|-----|--------|
| 6811 38 | Flat Indicator Red - 1 Module | 190 | 20/200 |
|---------|-------------------------------|-----|--------|

Bell Call Indicator

| | | | |
|---------|--------------------------------|-----|--------|
| 6811 46 | Bell Call Indicator - 1 Module | 816 | 20/200 |
|---------|--------------------------------|-----|--------|

Buzzer

| | | | |
|---------|--------------------------|-----|--------|
| 6811 39 | Buzzer - 230V - 1 Module | 364 | 20/200 |
|---------|--------------------------|-----|--------|

Remote Unit

| | | | |
|---------|--|------|--------|
| 6811 54 | Remote Control Unit - for Light & Fan - 4 Module | 5126 | 1/5/20 |
|---------|--|------|--------|

Hospitality Function
Hotel Keycard Switch

| | | | |
|---------|---|------|--------|
| 6811 17 | 32A - DP - Key Tag Switch (Mechanical) - 2 Module | 594 | 1/10 |
| 6811 79 | Keytag for (681117) WH | 276 | 10/100 |
| 6811 47 | 15A - Key Card Switch with Key Fob - Monoblock | 2864 | 1/10 |

Hotel "DND and MMR" Functions

| | | | |
|---------|---|-----|--------|
| 6811 48 | Internal DND & MMR Control Unit - 2 Module | 370 | 10/100 |
| 6811 49 | External DND & MMR Control Unit - with Bell Push - 2 Module | 436 | 10/100 |

Shaver Socket

| | | | |
|---------|---|------|--------|
| 6811 55 | Shaver Socket - 120V/230V - with Plate - 4 Module | 5384 | 1/5/20 |
|---------|---|------|--------|

Tv Sockets

| | | | |
|---------|---------------------------------|-----|--------|
| 6811 33 | TV Co - axial Socket - 1 Module | 134 | 20/200 |
|---------|---------------------------------|-----|--------|

Data & Voice

| | | | |
|---------|---|-----|--------|
| 6811 30 | Telephone Socket - RJ11 - with Shutter - 1 Module | 140 | 20/200 |
| 6811 31 | Telephone Socket - Double RJ11 - with Shutter - 1 Module | 212 | 20/200 |
| 6811 32 | Information Socket - RJ45 - Cat 6 - UTP - with Shutter - 1 Module | 729 | 20/200 |

Audio Video Connectors

| | | | |
|---------|--|------|------|
| 6811 34 | Preterminated HDMI Socket - 1 Module | 1380 | 1/10 |
| 6811 35 | Preterminated Audio/Video Connector - 1 Module | 1376 | 1/10 |
| 6811 36 | Preterminated Projector Connector - 1 Module | 1791 | 1/10 |

Sound (Electronic Bell)

| | | | |
|---------|----------------------------|-----|--------|
| 6811 45 | Electronic Bell - 2 Module | 408 | 10/100 |
|---------|----------------------------|-----|--------|

Protectors and Accessories
Motor Starter

| | | | |
|---------|--------------------------------|-----|----------|
| 6811 66 | 16A - Motor Starter - 2 Module | 666 | 1/10/100 |
| 6811 67 | 25A - Motor Starter - 2 Module | 666 | 1/10/100 |

Bold Cat.Nos are products normally available with Legrand (India) Stockists. Cat.Nos that are not bold - delivery within 4 - 8 weeks from the date of order. Bold packing quantity is our mandatory packing. Orders to be placed by Legrand (India) Stockist in multiples of the same.

Allzy™
White - Mechanism

| Cat.Nos | Description | MRP* ₹ / Unit | Pack |
|---------|-------------|------------------|------|
|---------|-------------|------------------|------|

Modular MCB (IS : 608981:2002)

| | | | |
|---------|-----------------------------------|-----|----------|
| 6811 56 | 6A - Modular MCB - SP - 1 Module | 502 | 1/10/100 |
| 6811 57 | 10A - Modular MCB - SP - 1 Module | 502 | 1/10/100 |
| 6811 58 | 16A - Modular MCB - SP - 1 Module | 502 | 1/10/100 |
| 6811 59 | 20A - Modular MCB - SP - 1 Module | 502 | 1/10/100 |
| 6811 60 | 25A - Modular MCB - SP - 1 Module | 502 | 1/10/100 |
| 6811 61 | 32A - Modular MCB - SP - 1 Module | 502 | 1/10/100 |
| 6811 62 | 16A - Modular MCB - DP - 2 Module | 954 | 1/10/100 |
| 6811 63 | 20A - Modular MCB - DP - 2 Module | 954 | 1/10/100 |
| 6811 64 | 25A - Modular MCB - DP - 2 Module | 954 | 1/10/100 |
| 6811 65 | 32A - Modular MCB - DP - 2 Module | 954 | 1/10/100 |

Power Unit

| | | | |
|---------|--|------|------|
| 6811 27 | Power Unit with 20A SP MCB & 16A Plug - 3 Module | 1484 | 1/10 |
| 6811 28 | Power Unit with 25A SP MCB & 16A Plug - 3 Module | 1588 | 1/10 |

Electronic Function
USB Chargers (IS13252 (Part 1) / IEC 60950-1)

| | | | |
|---------------------|---|------|--------|
| 6811 52 | USB Charger - 1500mA - Type A - 1 Module | 1116 | 10/100 |
| 6811 51 | USB Charger - 3000mA - Type A+ A - 2 Module | 1782 | 10/100 |
| 6811 70 | USB Charger - 3000mA - Type A + C - 2 Module | 2164 | 10/100 |
| 6811 80 | USB Charger - 3000mA/15 Watts - Type A - 1 Module | 1740 | 1/5/50 |
| 6811 81 | USB Charger - 3000mA/15 Watts - Type A + A - 1 Module | 1918 | 1/5/50 |
| 6811 82 | USB Charger - 3000mA/15 Watts - Type A + C - 1 Module | 2446 | 1/5/50 |
| 6811 83 | USB Charger - 3000mA/15 Watts - Type C + C - 1 Module | 2670 | 1/5/50 |
| 6811 84 | USB Charger - Power Delivery - 20 Watts - Type C - 1 Module | 3244 | 1/5/50 |
| 6811 85 | USB Charger - Power Delivery - 30 Watts - Type C + C - 2 Module | 6158 | 1/3/30 |
| 6811 86 | USB Charger - Power Delivery - 45 Watts - Type C - 2 Module | 7756 | 1/3/30 |
| NEW! 6811 96 | USB Charger - Power Delivery - 65 Watts - Type C + C - 3 Module | 9824 | 1/5/20 |

Accessories

| | | | |
|---------|-------------------------------|-----|--------|
| 6811 68 | Cable Outlet - 8MM - 1 Module | 112 | 20/200 |
| 6811 69 | Blanking Plate - 1 Module | 34 | 40/400 |

Matt Black Mechanism
Switches 6A - 230 V AC

| | | | |
|---------|--|-----|--------|
| 6812 00 | 6A - Switch - SP - 1 Way - 1 Module | 58 | 20/400 |
| 6812 11 | 6A - Switch - SP - 2 Way - 1 Module | 138 | 20/200 |
| 6812 02 | 6A - Switch - SP - 1 Way - with Indicator - 1 Module | 118 | 20/200 |
| 6812 03 | 6A - Switch - SP - 1 Way - with "Light" Marking - 1 Module | 124 | 20/200 |
| 6812 04 | 6A - Switch - SP - 1 Way - with "Fan" Marking - 1 Module | 124 | 20/200 |

Allzy™
Matt Black - Mechanism

| Cat.Nos | Description | MRP* ₹ / Unit | Pack |
|---------|-------------|------------------|------|
|---------|-------------|------------------|------|

Switches 16A - 230 V AC

| | | | |
|---------|---|-----|--------|
| 6812 01 | 16A - Switch - SP - 1 Way - 1 Module | 166 | 20/200 |
| 6812 12 | 16A - Switch - SP - 2 Way - 1 Module | 242 | 20/200 |
| 6812 05 | 16A - Switch - SP - 1 Way - with Indicator - 1 Module | 220 | 20/200 |

Switches 20A - 230V AC

| | | | |
|---------|---|-----|--------|
| 6812 07 | 20A - Switch - SP - 1 Way - 1 Module | 204 | 20/200 |
| 6812 08 | 20A - Switch - SP - 1 Way - with Indicator - 1 Module | 268 | 20/200 |
| 6812 13 | 20A - Switch - SP - 1 Way - with Indicator - 2 Module | 300 | 10/100 |
| 6812 15 | 20A - Switch - DP - 1 Way - with Indicator - 2 Module | 300 | 10/100 |

Switches 25A - 230 V AC

| | | | |
|---------|---|-----|--------|
| 6812 06 | 25A - Switch - SP - 1 Way - with Indicator - 1 Module | 276 | 20/200 |
|---------|---|-----|--------|

Switches 32A - 230 V AC

| | | | |
|---------|---|-----|--------|
| 6812 16 | 32A - Switch - DP - 1 Way - with Indicator - 2 Module | 410 | 10/100 |
|---------|---|-----|--------|

Push Button 6A - 230 V AC

| | | | |
|---------|---|-----|--------|
| 6812 09 | 6A - Bell Push - SP - 1 Way - 1 Module | 136 | 20/200 |
| 6812 10 | 6A - Bell Push - SP - 1 Way - with Indicator - 1 Module | 166 | 20/200 |
| 6812 14 | 6A - Bell Push - SP - 1 Way - with Indicator - 2 Module | 256 | 10/100 |

Indian Standard Sockets

| | | | |
|---------|---|-----|--------|
| 6812 24 | 6A - Socket - with Shutter - 3 Pin - ISI - 2 Module | 226 | 20/200 |
| 6812 22 | 6/16A - Socket - with Shutter - ISI - 2 Module | 306 | 10/100 |

Dimmers & Fan Regulators

| | | | |
|---------|---|-----|----------|
| 6812 43 | Rotary Dimmer - 400 Watts - 1 Module | 662 | 5/50 |
| 6812 44 | Rotary Dimmer - 500 Watts - 2 Module | 858 | 10/100 |
| 6812 40 | Fan Regulator - 4 Step - 100 Watts - ISI - 1 Module | 660 | 5/50 |
| 6812 41 | Fan Regulator - 100 Watts - with 360° Rotation - ISI - 2 Module | 750 | 10/100 |
| 6812 42 | Fan Regulator - 8 Step - 100 Watts - ISI - 2 Module | 848 | 1/10/100 |
| 6812 99 | Fan Regulator - BLDC - 2 Module^ | 764 | 10/100 |

Skirting Light

| | | | |
|---------|---------------------------|-----|---------|
| 6812 50 | Skirting Light - 2 Module | 536 | 1/10/50 |
|---------|---------------------------|-----|---------|

Indicator

| | | | |
|---------|-------------------------------|-----|--------|
| 6812 38 | Flat Indicator Red - 1 Module | 210 | 20/200 |
|---------|-------------------------------|-----|--------|

Buzzer

| | | | |
|---------|--------------------------|-----|--------|
| 6812 39 | Buzzer - 230V - 1 Module | 414 | 20/200 |
|---------|--------------------------|-----|--------|

Remote Unit

| | | | |
|---------|--|------|--------|
| 6812 54 | Remote Control Unit - for Light & Fan - 4 Module | 5440 | 1/5/20 |
|---------|--|------|--------|

Hospitality Function
Hotel Keycard Switch

| | | | |
|---------|---|------|--------|
| 6812 17 | 32A - DP - Key Tag Switch (Mechanical) - 2 Module | 676 | 1/10 |
| 6812 79 | Keytag for (681217) MB | 310 | 10/100 |
| 6812 47 | 15A - Key Card Switch with Key Fob - Monoblock | 3598 | 1/10 |

Hotel "DND and MMR" Functions

| | | | |
|---------|---|-----|--------|
| 6812 48 | Internal DND & MMR Control Unit - 2 Module | 456 | 10/100 |
| 6812 49 | External DND & CMR Control Unit - with Bell Push - 2 Module | 516 | 10/100 |

* MRP - Maximum Retail Price Inclusive of all taxes including GST.

^Compatible with Atomberg (Efficio), Havells (Efficiencia neo), Orient (Aerostorm) as per 2023 fan models.

Red Cat.Nos - new products

Bold Cat.Nos are products normally available with Legrand (India) Stockists. Cat.Nos that are not bold - delivery within 4 - 8 weeks from the date of order. Bold packing quantity is our mandatory packing. Orders to be placed by Legrand (India) Stockist in multiples of the same.

Allzy™ Matt Black - Mechanism

| Cat.Nos | Description | MRP* ₹ / Unit | Pack |
|---------|-------------|------------------|------|
|---------|-------------|------------------|------|

Shaver Socket

| | | | |
|---------|---|------|--------|
| 6812 55 | Shaver Socket - 120V/230V - with Plate - 4 Module | 6140 | 1/5/20 |
|---------|---|------|--------|

Tv Sockets

| | | | |
|---------|---------------------------------|-----|--------|
| 6812 33 | TV Co - axial Socket - 1 Module | 154 | 20/200 |
|---------|---------------------------------|-----|--------|

Data & Voice

| | | | |
|---------|---|-----|--------|
| 6812 30 | Telephone Socket - RJ11 - with Shutter - 1 Module | 166 | 20/200 |
| 6812 31 | Telephone Socket - Double RJ11 - with Shutter - 1 Module | 236 | 20/200 |
| 6812 32 | Information Socket - RJ45 - Cat 6 - UTP - with Shutter - 1 Module | 857 | 20/200 |

Audio Video Connectors

| | | | |
|---------|--|------|------|
| 6812 34 | Preterminated HDMI Socket - 1 Module | 1571 | 1/10 |
| 6812 35 | Preterminated Audio/Video Connector - 1 Module | 1570 | 1/10 |
| 6812 36 | Preterminated Projector Connector - 1 Module | 2040 | 1/10 |

Protectors & Accessories

Motor Starter

| | | | |
|---------|--------------------------------|-----|----------|
| 6812 66 | 16A - Motor Starter - 2 Module | 766 | 1/10/100 |
| 6812 67 | 25A - Motor Starter - 2 Module | 766 | 1/10/100 |

Modular MCB (IS : 608981:2002)

| | | | |
|---------|-----------------------------------|-----|----------|
| 6812 56 | 6A - Modular MCB - SP - 1 Module | 572 | 1/10/100 |
| 6812 57 | 10A - Modular MCB - SP - 1 Module | 572 | 1/10/100 |
| 6812 58 | 16A - Modular MCB - SP - 1 Module | 572 | 1/10/100 |
| 6812 59 | 20A - Modular MCB - SP - 1 Module | 572 | 1/10/100 |
| 6812 60 | 25A - Modular MCB - SP - 1 Module | 572 | 1/10/100 |
| 6812 61 | 32A - Modular MCB - SP - 1 Module | 572 | 1/10/100 |

Power Unit

| | | | |
|---------|--|------|------|
| 6812 27 | Power Unit with 20A SP MCB & 16A Plug - 3 Module | 1688 | 1/10 |
| 6812 28 | Power Unit with 25A SP MCB & 16A Plug - 3 Module | 1812 | 1/10 |

Electronic Function

USB Chargers (IS13252 (Part 1) / IEC 60950-1)

| | | | |
|---------------------|---|-------|--------|
| 6812 52 | USB Charger - 1500mA - Type A - 1 Module | 1402 | 10/100 |
| 6812 51 | USB Charger - 3000mA - Type A + A - 2 Module | 2072 | 10/100 |
| 6812 70 | USB Charger - 3000mA - Type A + C - 2 Module | 2470 | 10/100 |
| 6812 80 | USB Charger - 3000mA/15 Watts - Type A - 1 Module | 1918 | 1/5/50 |
| 6812 81 | USB Charger - 3000mA/15 Watts - Type A + A - 1 Module | 2124 | 1/5/50 |
| 6812 82 | USB Charger - 3000mA/15 Watts - Type A + C - 1 Module | 2644 | 1/5/50 |
| 6812 83 | USB Charger - 3000mA/15 Watts - Type C + C - 1 Module | 2892 | 1/5/50 |
| 6812 84 | USB Charger - Power Delivery - 20 Watts - Type C - 1 Module | 3656 | 1/5/50 |
| 6812 85 | USB Charger - Power Delivery - 30 Watts - Type C + C - 2 Module | 6630 | 1/3/30 |
| 6812 86 | USB Charger - Power Delivery - 45 Watts - Type C - 2 Module | 8552 | 1/3/30 |
| NEW! 6812 96 | USB Charger - Power Delivery - 65 Watts - Type C + C - 3 Module | 10474 | 1/5/20 |

* MRP - Maximum Retail Price Inclusive of all taxes including GST.
Red Cat. Nos - New Products

Allzy™ Matt Black - Mechanism

| Cat.Nos | Description | MRP* ₹ / Unit | Pack |
|---------|-------------|------------------|------|
|---------|-------------|------------------|------|

Accessories

| | | | |
|---------|-------------------------------|-----|--------|
| 6812 68 | Cable Outlet - 8MM - 1 Module | 128 | 20/200 |
| 6812 69 | Blanking Plate - 1 Module | 40 | 40/400 |

Cover Plates with Support Frame White Cover Plates with Support Frame

| | | | |
|---------|---|-----|--------|
| 6813 00 | Cover Plate + Frame - 1 Module - White | 144 | 20/200 |
| 6813 01 | Cover Plate + Frame - 2 Module - White | 144 | 20/200 |
| 6813 02 | Cover Plate + Frame - 3 Module - White | 204 | 10/100 |
| 6813 03 | Cover Plate + Frame - 4 Module - White | 216 | 10/100 |
| 6813 04 | Cover Plate + Frame - 6 Module - White | 296 | 5/50 |
| 6813 05 | Cover Plate + Frame - 8 Module - Horizontal-White | 362 | 5/50 |
| 6813 06 | Cover Plate + Frame - 2*4 Module - Vertical-White | 362 | 5/25 |
| 6813 07 | Cover Plate + Frame - 9 Module - White | 420 | 5/50 |
| 6813 08 | Cover Plate + Frame - 12 Module - White | 520 | 10 |
| 6813 09 | Cover Plate + Frame - 16 Module - White | 556 | 10 |
| 6813 10 | Cover Plate + Frame - 18 Module - White | 594 | 10 |

Matt Black Cover Plates With Support Frame

| | | | |
|---------|---|-----|--------|
| 6813 11 | Cover Plate with Frame - 1 Module - Matt Black | 184 | 20/200 |
| 6813 12 | Cover Plate with Frame - 2 Module - Matt Black | 184 | 20/200 |
| 6813 13 | Cover Plate with Frame - 3 Module - Matt Black | 242 | 10/100 |
| 6813 14 | Cover Plate with Frame - 4 Module - Matt Black | 278 | 10/100 |
| 6813 15 | Cover Plate with Frame - 6 Module - Matt Black | 378 | 5/50 |
| 6813 16 | Cover Plate with Frame - 8 Module - Horizontal-Matt Black | 416 | 5/50 |
| 6813 17 | Cover Plate with Frame - 2*4 Module - Vertical-Matt Black | 416 | 5/25 |
| 6813 18 | Cover Plate with Frame - 9 Module - Matt Black | 502 | 5/50 |
| 6813 19 | Cover Plate with Frame - 12 Module - Matt Black | 606 | 10 |
| 6813 20 | Cover Plate with Frame - 16 Module - Matt Black | 690 | 10 |
| 6813 21 | Cover Plate with Frame - 18 Module - Matt Black | 734 | 10 |

Gold Cover Plates with Support Frame

| | | | |
|---------|---|-----|--------|
| 6813 33 | Cover Plate with Frame - 1 Module - Gold | 194 | 20/200 |
| 6813 34 | Cover Plate with Frame - 2 Module - Gold | 194 | 20/200 |
| 6813 35 | Cover Plate with Frame - 3 Module - Gold | 262 | 10/100 |
| 6813 36 | Cover Plate with Frame - 4 Module - Gold | 284 | 10/100 |
| 6813 37 | Cover Plate with Frame - 6 Module - Gold | 420 | 5/50 |
| 6813 38 | Cover Plate with Frame - 8 Module - Horizontal-Gold | 468 | 5/50 |
| 6813 39 | Cover Plate with Frame - 2*4 Module - Vertical-Gold | 468 | 5/25 |
| 6813 40 | Cover Plate with Frame - 9 Module - Gold | 562 | 5/50 |
| 6813 41 | Cover Plate with Frame - 12 Module - Gold | 676 | 10 |
| 6813 42 | Cover Plate with Frame - 16 Module - Gold | 734 | 10 |
| 6813 43 | Cover Plate with Frame - 18 Module - Gold | 778 | 10 |

Bold Cat.Nos are products normally available with Legrand (India) Stockists. Cat.Nos that are not bold - delivery within 4 - 8 weeks from the date of order. Bold packing quantity is our mandatory packing. Orders to be placed by Legrand (India) Stockist in multiples of the same.

Allzy™
Cover Plates

| Cat.Nos | Description | MRP* ₹ / Unit | Pack |
|---------|-------------|------------------|------|
|---------|-------------|------------------|------|

Aluminium Champagne Cover Plates with Support Frame

| | | | |
|---------|---|-----|--------|
| 6813 44 | Cover Plate with Frame - 1 Module - Aluminium Champagne | 194 | 20/200 |
| 6813 45 | Cover Plate with Frame - 2 Module - Aluminium Champagne | 194 | 20/200 |
| 6813 46 | Cover Plate with Frame - 3 Module - Aluminium Champagne | 262 | 10/100 |
| 6813 47 | Cover Plate with Frame - 4 Module - Aluminium Champagne | 284 | 10/100 |
| 6813 48 | Cover Plate with Frame - 6 Module - Aluminium Champagne | 420 | 5/50 |
| 6813 49 | Cover Plate with Frame - 8 Module - Horizontal- Aluminium Champagne | 468 | 5/50 |
| 6813 50 | Cover Plate with Frame - 2*4 Module - Vertical- Aluminium Champagne | 468 | 5/25 |
| 6813 51 | Cover Plate with Frame - 9 Module - Aluminium Champagne | 562 | 5/50 |
| 6813 52 | Cover Plate with Frame - 12 Module - Aluminium Champagne | 676 | 10 |
| 6813 53 | Cover Plate with Frame - 16 Module - Aluminium Champagne | 734 | 10 |
| 6813 54 | Cover Plate with Frame - 18 Module - Aluminium Champagne | 778 | 10 |

Rose Gold Cover Plates with Support Frame

| | | | |
|---------|--|-----|--------|
| 6813 55 | Cover Plate with Frame - 1 Module - Rose Gold | 194 | 20/200 |
| 6813 56 | Cover Plate with Frame - 2 Module - Rose Gold | 194 | 20/200 |
| 6813 57 | Cover Plate with Frame - 3 Module - Rose Gold | 262 | 10/100 |
| 6813 58 | Cover Plate with Frame - 4 Module - Rose Gold | 284 | 10/100 |
| 6813 59 | Cover Plate with Frame - 6 Module - Rose Gold | 420 | 5/50 |
| 6813 60 | Cover Plate with Frame - 8 Module - Horizontal-Rose Gold | 468 | 5/50 |
| 6813 61 | Cover Plate with Frame - 2*4 Module - Vertical-Rose Gold | 468 | 5/25 |
| 6813 62 | Cover Plate with Frame - 9 Module - Rose Gold | 562 | 5/50 |
| 6813 63 | Cover Plate with Frame - 12 Module - Rose Gold | 676 | 10 |
| 6813 64 | Cover Plate with Frame - 16 Module - Rose Gold | 734 | 10 |
| 6813 65 | Cover Plate with Frame - 18 Module - Rose Gold | 778 | 10 |

* MRP - Maximum Retail Price Inclusive of all taxes including GST.

Allzy™
Mounting Boxes

| Cat.Nos | Description | MRP* ₹ / Unit | Pack |
|---------|-------------|------------------|------|
|---------|-------------|------------------|------|

Accessories
Metal Flush Boxes

| | | | |
|---------|--|-----|----|
| 6890 60 | Metal Flush Box - 1 & 2 Module | 88 | 40 |
| 6890 61 | Metal Flush Box - 3 Module | 116 | 40 |
| 6890 62 | Metal Flush Box - 4 Module | 140 | 40 |
| 6890 63 | Metal Flush Box - 6 Module | 222 | 40 |
| 6890 65 | Metal Flush Box - 8 Module | 278 | 40 |
| 6890 64 | Metal Flush Box - 8 (2 Rows*4) Module | 278 | 20 |
| 6890 66 | Metal Flush Box - 12 (2 Rows*6) Module | 386 | 10 |
| 6890 67 | Metal Flush Box - 16 (2 Rows*8) Module | 436 | 10 |
| 6890 68 | Metal Flush Box - 18 Module | 498 | 10 |

Plastic Surface Boxes

| | | | |
|---------|--|-----|----|
| 6890 70 | Plastic Surface Box - 1 & 2 Module | 70 | 50 |
| 6890 71 | Plastic Surface Box - 3 Module | 86 | 35 |
| 6890 72 | Plastic Surface Box - 4 Module | 112 | 25 |
| 6890 73 | Plastic Surface Box - 6 Module | 168 | 10 |
| 6813 70 | Plastic Surface Box - 8 Module | 254 | 10 |
| 6890 74 | Plastic Surface Box - 8 (2 Rows*4) Module | 230 | 10 |
| 6890 76 | Plastic Surface Box - 12 (2 Rows*6) Module | 280 | 10 |
| 6890 77 | Plastic Surface Box - 16 (2 Rows*8) Module | 330 | 10 |

Metal Surface Box

| | | | |
|---------|-------------------------------|-----|----|
| 6890 78 | Metal Surface Box - 18 Module | 350 | 10 |
|---------|-------------------------------|-----|----|

Our switches are compliant with revised BIS standard (IS 3854:2023 requirements). Also, our switches are covered additionally for use on Self-Ballasted Lamp (SBL) loads.

SBL power rating as per IS3854:2023

| Switch Rating | 6A, 230V~ | 10A, 230V~ | 16A, 230V~ | 20A, 230V~ |
|------------------|-----------|------------|------------|------------|
| SBL power (Watt) | 100 W | 100 W | 200 W | 250 W |

Bold Cat.Nos are products normally available with Legrand (India) Stockists. Cat.Nos that are not bold - delivery within 4 - 8 weeks from the date of order. Bold packing quantity is our mandatory packing. Orders to be placed by Legrand (India) Stockist in multiples of the same.

Britzy™ SWITCHES

Stylish Everyday Switches



Britzy™ is a switch range designed for everyday convenience. With reliable mechanisms and practical modules for power and connectivity, it offers a solution for contemporary homes and workplaces.

Features

- Complete switch range from 6A-32A tested & validated as per IS norms
- Range of shuttered sockets with 6A & 6/16A ratings for everyday usage
- Electronics range with fan regulators, dimmers & USB charging
- Connectivity solutions with data sockets & Hospitality range catering to a wide range of customers

Benefits

- Supports all load requirements—from light-duty to heavy-duty (16A-32A for ACs, geysers, appliances)
- Reliable performance for routine household and office needs
- Covers essential electrical controls in one range—fan speed, lighting intensity, and device charging
- Suitable for residential, commercial, and hospitality applications

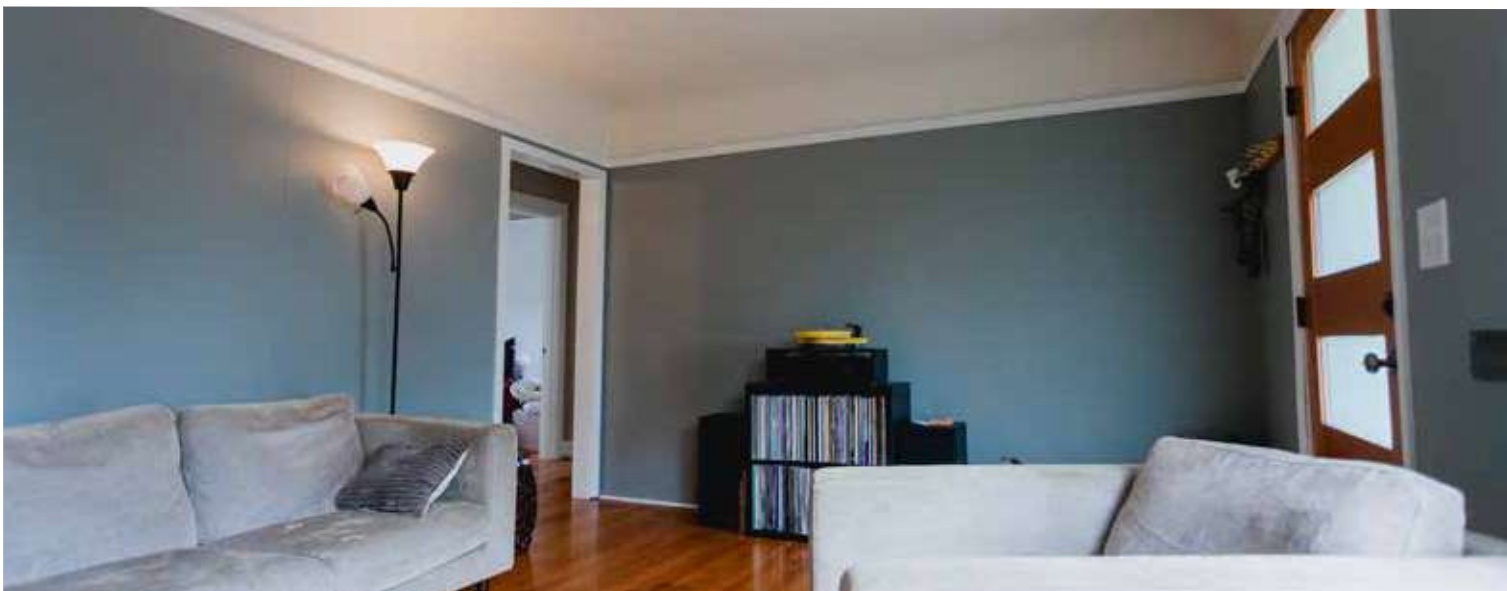

Range



Switch 6 A, 16 A



Switch 6 A two-way



Switch with indicator
6 A, 16 A, 25 A



Bell push with
indicator - 1 module



DP Switch 20 A, 32 A



Bell push with
indicator - 2 module



DND internal unit



DND external unit



6/16 A socket



Dimmer



Fan regulator
1 module



Fan regulator
2 module



USB charger
1 module



RJ 45



RJ 11 Telephone socket



Double RJ 11
Telephone socket



Bell call indicator



TV socket



Skirting light



Buzzer



Key card Switch 15 A



Flat indicator red

Scan to know more about
the product.



Britzy™

White Mechanism

| Cat.Nos | Description | MRP* ₹ / Unit | Pack |
|---------|-------------|---------------------|------|
|---------|-------------|---------------------|------|

Switches – 6A - 230V AC

| | | | |
|---------|--|-----|--------|
| 6734 01 | 6A - Switch - SP - 1 Way - 1 Module | 54 | 20/400 |
| 6734 02 | 6A - Switch - SP - 2 Way - 1 Module | 128 | 20/200 |
| 6734 03 | 6A - Switch - SP - 1 Way - with Indicator - 1 Module | 128 | 20/200 |

Switches – 16A - 230V AC

| | | | |
|---------|---|-----|--------|
| 6734 11 | 16A - Switch - SP - 1 Way - 1 Module | 184 | 20/200 |
| 6734 12 | 16A - Switch - SP - 2 Way - 1 Module | 222 | 20/200 |
| 6734 13 | 16A - Switch - SP - 1 Way - with Indicator - 1 Module | 198 | 20/200 |

Switches – 20A - 230V AC

| | | | |
|---------|---|-----|--------|
| 6734 25 | 20A - Switch - DP - 1 Way - with Indicator - 2 Module | 284 | 10/100 |
|---------|---|-----|--------|

Switches – 25A - 230V AC

| | | | |
|---------|---|-----|--------|
| 6734 24 | 25A - Switch - SP - 1 Way - with Indicator - 1 Module | 252 | 20/200 |
|---------|---|-----|--------|

Switches – 32A - 230V AC

| | | | |
|---------|---|-----|--------|
| 6734 26 | 32A - Switch - DP - 1 Way - with Indicator - 2 Module | 370 | 10/100 |
|---------|---|-----|--------|

Push Buttons

| | | | |
|---------|--|-----|--------|
| 6734 04 | 6A - Bell Push - with Indicator - 1 Module | 154 | 20/200 |
| 6734 06 | 6A - Bell Push - with Indicator - 2 Module | 232 | 10/100 |

Indian Standard Sockets

| | | | |
|---------|---|-----|--------|
| 6734 27 | 6A - Socket - with Shutter - 3 Pin - ISI - 2 Module | 160 | 20/200 |
| 6734 55 | 6/16A - Socket - with Shutter - 3 Pin - 2 Module | 278 | 10/100 |

Data & Voice

| | | | |
|---------|---|-----|--------|
| 6734 41 | Telephone Socket - RJ11 - 1 Module | 146 | 20/200 |
| 6734 44 | Telephone Socket - Double RJ11 - 1 Module | 212 | 20/200 |
| 6734 45 | Information Socket - RJ45 - Cat 6-UTP with shutter - 1 Module | 340 | 20/200 |

* MRP - Maximum Retail Price Inclusive of all taxes including GST.

Britzy™

White Mechanism

| Cat.Nos | Description | MRP* ₹ / Unit | Pack |
|---------|-------------|---------------------|------|
|---------|-------------|---------------------|------|

Television Socket

| | | | |
|---------|---------------------------------|-----|--------|
| 6734 46 | TV Co - axial Socket - 1 Module | 134 | 20/200 |
|---------|---------------------------------|-----|--------|

Buzzer

| | | | |
|---------|--------------------------|-----|--------|
| 6734 40 | Buzzer - 230V - 1 Module | 392 | 20/200 |
|---------|--------------------------|-----|--------|

Dimmers & Fan Regulators

| | | | |
|---------|---|-----|--------|
| 6734 33 | Light Dimmer - 400 Watts - 1 Module | 620 | 5/50 |
| 6734 31 | Fan Regulator - 100 Watts - ISI - 1 Module | 604 | 5/50 |
| 6734 30 | Fan Regulator - 100 Watts - ISI - 2 Module | 770 | 10/100 |
| 6734 38 | Fan Regulator - 8 Step - 100 Watts - ISI - 2 Module | 694 | 10/100 |

Bell Call Indicator

| | | | |
|---------|--------------------------------|-----|--------|
| 6734 07 | Bell Call Indicator - 1 Module | 840 | 20/200 |
|---------|--------------------------------|-----|--------|

Motor Starter

| | | | |
|---------|--------------------------------|-----|--------|
| 6734 66 | 25A - Motor Starter - 2 Module | 710 | 10/100 |
|---------|--------------------------------|-----|--------|

Modular MCB (IS : 60898-1:2002)

| | | | |
|---------|-----------------------------------|-----|----------|
| 6734 64 | 16A - Modular MCB - SP - 1 Module | 486 | 1/10/100 |
| 6734 61 | 20A - Modular MCB - SP - 1 Module | 486 | 1/10/100 |
| 6734 36 | 25A - Modular MCB - SP - 1 Module | 486 | 1/10/100 |
| 6734 37 | 32A - Modular MCB - SP - 1 Module | 486 | 1/10/100 |

USB Charger

| | | | |
|---------|--|------|--------|
| 6731 35 | USB Charger - 1500mA - Type A - 1 Module | 1254 | 10/100 |
|---------|--|------|--------|

Skirting Light

| | | | |
|---------|---------------------------|-----|------|
| 6734 77 | Skirting Light - 2 Module | 602 | 5/50 |
|---------|---------------------------|-----|------|

Indicator

| | | | |
|---------|-------------------------------|-----|--------|
| 6734 75 | Flat Indicator Red - 1 Module | 154 | 20/200 |
|---------|-------------------------------|-----|--------|

Bold Cat.Nos are products normally available with Legrand (India) Stockists. Cat.Nos that are not bold - delivery within 4 - 8 weeks from the date of order. Bold packing quantity is our mandatory packing. Orders to be placed by Legrand (India) Stockist in multiples of the same.

Britzy™

White Mechanism

| Cat.Nos | Description | MRP* ₹ / Unit | Pack |
|---------|-------------|------------------|------|
|---------|-------------|------------------|------|

Hospitality Function

Hotel Keycard Switch

| | | | |
|---------|----------------------------------|------|----------|
| 6734 80 | 15A - Key Card Switch - 2 Module | 3018 | 1/10 |
| 6734 83 | Key Fob for Key Card Switch | 220 | 1/10/100 |



6734 80

Hotel "DND and MMR" Functions

| | | | |
|---------|---|-----|----------|
| 6734 81 | Internal DND & MMR Control Unit - 2 Module | 340 | 1/10/100 |
| 6734 82 | External DND & MMR Control Unit - with Bell Push - 2 Module | 398 | 1/10/100 |



6734 82

Accessories

| | | | |
|---------|---------------------------|-----|--------|
| 6734 71 | Cable Outlet - 1 Module | 116 | 20/200 |
| 6734 90 | Blanking Plate - 1 Module | 38 | 40/400 |
| 6734 72 | Blanking Plate - 2 Module | 52 | 10/100 |

Cover Plates with Support Frame

White Cover Plates with Support Frame

| | | | |
|---------|---|-----|--------|
| 6734 91 | Cover Plate + Support Frame - 1 Module - White | 122 | 20/200 |
| 6734 92 | Cover Plate + Support Frame - 2 Module - White | 122 | 20/200 |
| 6734 93 | Cover Plate + Support Frame - 3 Module - White | 168 | 10/100 |
| 6734 94 | Cover Plate + Support Frame - 4 Module - White | 176 | 10/100 |
| 6734 96 | Cover Plate + Support Frame - 6 Module - White | 236 | 5/50 |
| 6734 98 | Cover Plate + Support Frame - 8 Module - Horizontal - White | 302 | 5/50 |
| 6734 95 | Cover Plate + Support Frame - 2*4 Module - Vertical - White | 302 | 5/25 |
| 6734 97 | Cover Plate + Support Frame - 12 Module - White | 438 | 10 |
| 6734 99 | Cover Plate + Support Frame - 16 Module - White | 470 | 10 |
| 6735 00 | Cover Plate + Support Frame - 18 Module - White | 578 | 10 |



6734 91



6734 92



6734 93



6734 96

Britzy™

Plates with Frame

| Cat.Nos | Description | MRP* ₹ / Unit | Pack |
|---------|-------------|------------------|------|
|---------|-------------|------------------|------|

Accessories

Metal Flush Boxes

| | | | |
|---------|--|-----|----|
| 6890 60 | Metal Flush Box - 1 & 2 Module | 88 | 40 |
| 6890 61 | Metal Flush Box - 3 Module | 116 | 40 |
| 6890 62 | Metal Flush Box - 4 Module | 140 | 40 |
| 6890 63 | Metal Flush Box - 6 Module | 222 | 40 |
| 6890 65 | Metal Flush Box - 8 Module | 278 | 40 |
| 6890 64 | Metal Flush Box - 8 (2 Rows*4) Module | 278 | 20 |
| 6890 66 | Metal Flush Box - 12 (2 Rows*6) Module | 386 | 10 |
| 6890 67 | Metal Flush Box - 16 (2 Rows*8) Module | 436 | 10 |
| 6890 68 | Metal Flush Box - 18 Module | 498 | 10 |



6890 60



6890 61



6890 63

Plastic Surface Boxes

| | | | |
|---------|--|-----|----|
| 6890 70 | Plastic Surface Box - 1 & 2 Module | 70 | 50 |
| 6890 71 | Plastic Surface Box - 3 Module | 86 | 35 |
| 6890 72 | Plastic Surface Box - 4 Module | 112 | 25 |
| 6890 73 | Plastic Surface Box - 6 Module | 168 | 10 |
| 6890 75 | Plastic Surface Box - 8 Module | 230 | 10 |
| 6890 74 | Plastic Surface Box - 8 (2 Rows*4) Module | 230 | 10 |
| 6890 76 | Plastic Surface Box - 12 (2 Rows*6) Module | 280 | 10 |
| 6890 77 | Plastic Surface Box - 16 (2 Rows*8) Module | 330 | 10 |

Metal Surface Box

| | | | |
|---------|-----------------------------|-----|----|
| 6890 78 | Metal Surface Box-18 Module | 350 | 10 |
|---------|-----------------------------|-----|----|

* MRP - Maximum Retail Price Inclusive of all taxes including GST.

Bold Cat.Nos are products normally available with Legrand (India) Stockists. Cat.Nos that are not bold - delivery within 4 - 8 weeks from the date of order. Bold packing quantity is our mandatory packing. Orders to be placed by Legrand (India) Stockist in multiples of the same.

Britzy™ SWITCHES

THE NO PROBLEM SWITCH



Guarantee

- The Company, at its discretion, will replace products if they have any manufacturing defect within 10 years for switches (without LED lamp) and power sockets. For all other Britzy™ wiring accessories the guarantee will be 2 years.
- The above guarantee is applicable when the devices are used in Legrand metal flush boxes. Otherwise the guarantee period will be reduced by 50%.
- The guarantee is only applicable when the products are installed as per the Company's instructions and not tampered in any manner.
- The guarantee states the Company's entire liability. It does not extend to cover consequential loss or damage or installation costs arising from defective products.

Our switches are compliant with revised BIS standard (IS 3854:2023) requirements. Also, our switches are covered additionally for use on Self-Ballasted Lamp (SBL) loads.

SBL power rating as per IS3854:2023

| Switch Rating | 6A, 230V~ | 10A, 230V~ | 16A, 230V~ | 20A, 230V~ |
|------------------|-----------|------------|------------|------------|
| SBL power (Watt) | 100 W | 100 W | 200 W | 250 W |

10A SWITCHES

Switch Type: 10A 1Way



Myrius

Mylinc

Lyncus

Allzy

Switch Type: 10A 1Way With Indicator



Myrius

Mylinc

Lyncus

Allzy

Switch Type: 10A 2Way



Myrius

Mylinc

Lyncus

Allzy

Colour: White

RANGES: Myrius™ | Mylinc™ | Lyncus™ | Allzy™



USB CHARGING SOLUTIONS

Available with Fast Charging & Industry First Laptop Charging Solutions



MOBILE CHARGING SOLUTIONS



USB Type: A Type
Rating: 15W-3A - 1M



USB Type: A+A Type
Rating: 15W-3A - 1M



USB Type: A+C Type
Rating: 15W-3A - 1M



USB Type: C+C Type
Rating: 15W-3A - 1M



USB Type: C Type
Rating: 20W-PD - 1M

RANGES: **LIVING now** | **ARTEOR™ ADVANCE** FEEL SOMETHING NEW | ARTEOR™ | Myrius™ | Lyncus™ | Allzy™

MOBILE AND LAPTOP CHARGING SOLUTIONS

Compatible for Laptop Charging



USB Type: C+C Type
Rating: 30W-PD - 2M



USB Type: C Type
Rating: 45W-PD - 2M



USB Type: C+C Type
Rating: 65W-PD - 3M

RANGES: **LIVING now** | **ARTEOR™ ADVANCE** FEEL SOMETHING NEW | ARTEOR™ | Myrius™ | Lyncus™ | Mylinc | Allzy™

RANGES: **ARTEOR™ ADVANCE** FEEL SOMETHING NEW | ARTEOR™ | Myrius™ | Lyncus™ | Allzy™



BLDC FAN

Regulator

Control for Energy-Efficient Fans

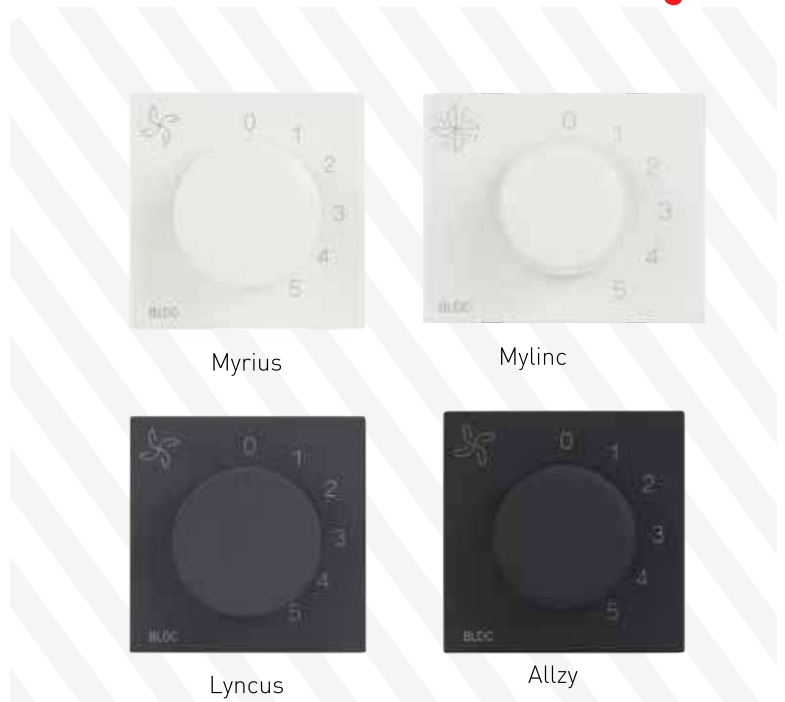

BLDC Fan Regulator enables smooth and efficient speed regulation for BLDC ceiling fans (non-remote), helping optimise comfort and power usage in modern homes. Designed to integrate seamlessly with modular wiring devices, it combines precise control with refined aesthetics.

Features

- Exclusive compatibility with BLDC ceiling fans (non-remote)
- Advanced speed control mechanism for smooth adjustment
- Modular design compatible with Myrius, Mylinc, Lyncus & Allzy switch plates

Benefits

- Maximizes energy efficiency compared to traditional regulators
- Improves comfort with effortless and precise fan speed control
- Enhances interior aesthetics with coordinated modular styling
- Ensures reliable everyday performance in residential spaces

Available in white and color mechanism finishes

RANGES: Myrius™ | Mylinc™ | Lyncus™ | Allzy

*Please note that only the following models are supported: Atomberg (Efficio), Havells (Efficiencia neo), and Orient (Aerostorm) as of the 2023 models.

*Suitable for Fans with declaration from manufacturers for application of Step fan regulator



LIVING NOW KNX

KEYPADS

Intelligent Room Controls

Living Now KNX keypads provide an intuitive interface for smart building environments, enabling effortless room-level control through the KNX bus. Designed to complement modern interiors, the range offers multiple mechanism colours and plate finishes for seamless architectural integration.

Features

- 4/6-channel KNX keypads for customizable scene and device control
- Dedicated controls for lighting, blinds, HVAC, and sockets within KNX systems
- Mechanism color options in white, sand and black with a wide plate finish selection
- Compatible with KNX automation ecosystems, including touch controllers

Benefits

- Simplifies smart building interaction with intuitive fingertip controls
- Enhances occupant comfort through precise management of lighting, climate, and shading
- Supports energy efficiency with centralized automation via KNX systems
- Maintains design harmony with customizable finishes suited for contemporary interiors



LIVING NOW KNX Keypads: Smart Control at your Fingertips

Available in 4 and 6 channel controls, our KNX keypads are available in 3 mechanism colors and 16 plate finishes. Manage lighting, shutters, sockets, and HVAC effortlessly.



WHITE



SAND



BLACK



LIVING NOW IoT

Redefining Smart Living

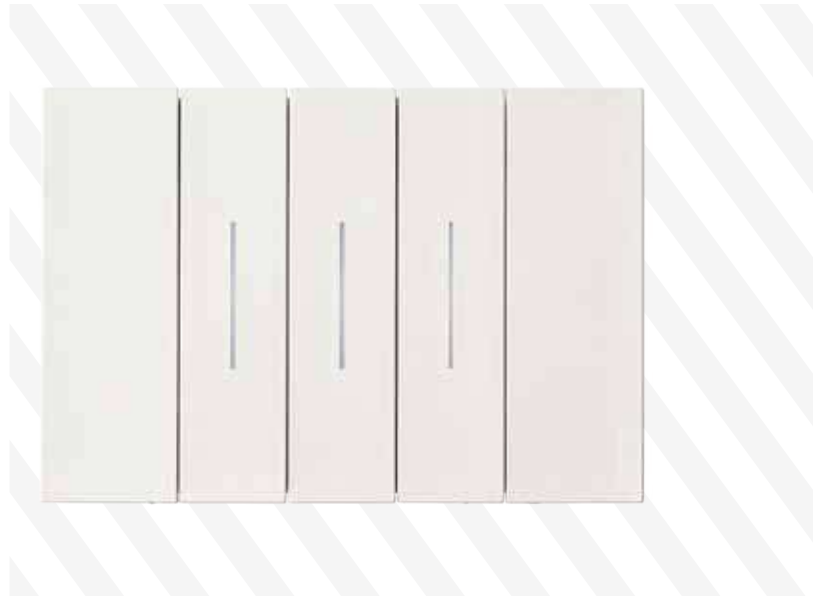

Living Now IoT is a connected home solution that enables intuitive control of lighting, power, and automation through wireless technology. Combining elegant touch interfaces with smartphone and voice control, it brings seamless smart living to modern homes without complex rewiring.

Features

- Multi-platform control through touch panels, smartphone apps, and voice assistants
- Wireless smart scenes enabling instant control of lighting and connected appliances
- Seamless compatibility with Apple HomeKit, Google Home, and Amazon Alexa ecosystems

Benefits

- Simplifies Smart Upgrades with wireless installation and minimal infrastructure changes
- Enhances Everyday Convenience through unified control from mobile devices or voice commands
- Creates Personalized Living Experiences using automated lighting and appliance scenes

WIRELESS 4 SCENARIOS CONTROL

Works with



Control with

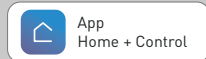

Touch control



Control with
smartphone



Voice control



REDEFINING SMART LIVING



MIX OF INNOVATION AND SIMPLICITY, READY TO BE DISCOVERED.



TOUCH CONTROL



CONTROL WITH
SMARTPHONE



VOICE CONTROL



Living Now, has won this prestigious international award confirming Legrand's ability to combine technology and design.



Workstation Power and Data Solutions

Flexible Power and Data Access for Modern Workspaces

Legrand Workstation Solutions provide a complete and integrated approach to power and data distribution for modern office environments. Combining floor boxes, raised and screed floor systems, pop-up desk units, and perimeter trunking, the range is designed to deliver seamless connectivity, organized cable management, and flexible workstation layouts. Engineered for both performance and aesthetics, these solutions ensure easy installation, scalability, and adaptability to evolving workspace needs—making them ideal for dynamic offices, commercial spaces, and collaborative environments.

Features

- Comprehensive solution for power, AV & data distribution
- Compatible with perimeter, desk, raised access floors and screed floor systems
- Designed for fast installation with high reliability, robustness, and flexibility
- Engineered for strength, supporting superior load capacities for demanding environments

Benefits

- Ensures organized and efficient power and data distribution across office spaces
- Enables flexible workstation layouts with easily accessible floor and desk outlets
- Improves workspace aesthetics with concealed and flush-mounted installations
- Supports scalable infrastructure for high-density workstation environments and future expansion

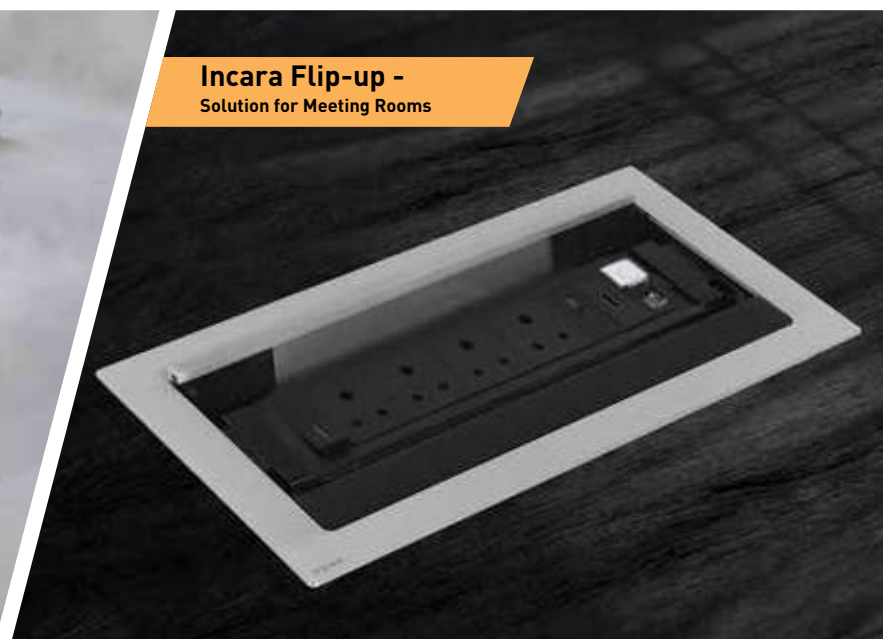

Alongside the Incara™ range, Legrand provides additional workspace solutions such as trunking systems, raised floor boxes, metal and aluminium floor outlets, desk grommets, and underfloor distribution to support scalable office infrastructure.



Soluflex cable floor system



Raceways : PVC & Metal (GI)



Floor boxes

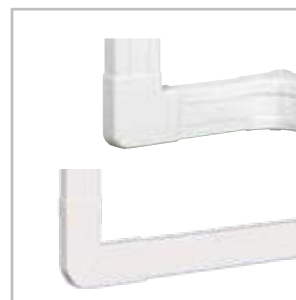

Dlp trunking system:
Snap-on, Mini & PVC, Aluminium



Cablofil wire mesh cable trays

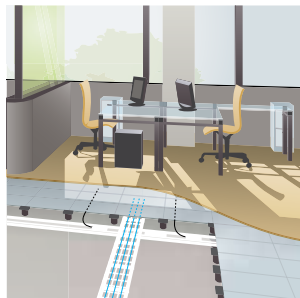

Raised access floor systems



Screed floor system



Wall and ceiling systems

Scan to know more about the product.



Incara Top Access



Disq 80



Disq 60

INCARA™ Pop-up Box

Elegant Design with Seamless Connectivity



Incara™ Pop-up provides convenient access to power, data, and charging for laptops, smartphones, tablets, and AV equipment directly at the workspace. Its patented design integrates discreetly into furniture, offering smooth damper operation and premium finishes that blend seamlessly with modern interiors.

Features

- Extra-slim pop-up design compatible with 15–40 mm desktops
- Multiple module configurations available in 3, 4, 8, and 2x4 formats. Also available 4 module in IP44 option
- Premium finishes including White, Black, Aluminium, and Brushed Aluminium
- Compatible with 250+ Arteor & Advance modules, including USB-C PD up to 63/65W

Benefits

- Improves workspace efficiency with easy access to power and connectivity
- Maintains a clean desk aesthetic with discreet, flush integration into furniture
- Ensures reliable daily use with robust construction and protection options
- Adapts to evolving technology needs through modular configuration and fast charging support

Now Available with
Arteor™ Advance Modules



Scan to know more about
the product.



INCARA™ Flip-up Box

Elegant Connectivity for Premium Meeting Rooms



Incara™ Flip-up is a premium tabletop connectivity solution designed for modern meeting rooms. Its fully metal construction and patented push-to-open mechanism allow the unit to rise smoothly while the cover slides discreetly inside even with devices plugged in providing seamless access to power, data, and AV connections.

Features

- Patented push-to-open flip mechanism with smooth, dual-sided access
- Robust all-metal construction with premium finish
- Quick, tool-free installation for 15–40 mm desktops
- Pre-equipped Arteor modules including sockets, USB-C charging, HDMI, and RJ45

Benefits

- Enhances meeting room aesthetics with discreet, integrated connectivity
- Improves collaboration through easy access to power and data from both sides
- Reduces installation time with fast and secure mounting design
- Supports modern AV setups with versatile power, data, and charging options



Now Available with
Arteor™ Advance Modules

Scan to know more about
the product.



INCARA™ Top Access

Discreet Cable Management for Meeting Tables



Incara™ Top Access provides a practical solution for organizing power modules and cables beneath meeting tables. With a flush-mounted lid and integrated storage basket, it keeps worktops clear while allowing easy access to chargers, power strips, and connectivity modules in modern meeting and collaboration spaces.

Features

- Integrated metal storage basket for power strips and excess cabling
- Two width options: 295 mm and 385 mm for different table sizes
- Premium finishes: White, Black, and Metal to match furniture styles
- Flush-mount lid with soft-close damper for 10–40 mm desktops

Benefits

- Keeps meeting tables organised by concealing cables and adapters
- Maintains a clean, professional workspace appearance
- Simplifies cable routing with dedicated under-desk storage
- Supports flexible integration with office power and connectivity modules



Scan to know more about the product.



Incara™ Flip up

| Cat.Nos | Description | MRP* ₹ / Unit | Pack |
|---------|-------------|------------------|------|
|---------|-------------|------------------|------|

Max. power: 3680 W at 230 VA
 6A switch d IS 3854 : 1997
 6A sockets IS 1293: 2019
 USB IEC 60950 1
 IS 13252(Part 1)
 Protection IK 07 & IP 30
 For flush mounting in furniture,
 Compatible for desk thickness 15 to 40
Incara™ Flip up Pre Equipped (Arteor Advance)

| | | | |
|---------|--|-------|---|
| 6540 24 | Flip-up 8M SW 2 SKT USB C+C 1 HDMI | 37480 | 1 |
| 6540 25 | Flip-up 8M SW 2 SKT USB C+C 1 RJ45 1 HDMI | 38376 | 1 |
| 6540 26 | Flip-up 12M SW 4 SKT USB C+C 1 HDMI | 41476 | 1 |
| 6540 27 | Flip-up 12M SW 4 SKT USB C+C 1 RJ45 1 HDMI | 42338 | 1 |



6540 24

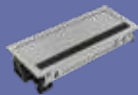

6540 27

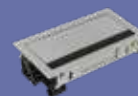

6540 22

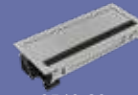

6540 23

INCARA Flip Up (Empty)

To be equipped version of the Incara Flip up is compatible with Arteor Advance accessories, which need to be purchased separately.

| | | | |
|---------|------------------------------------|-------|---|
| 6540 22 | Flip-up 8M To Be Equipped Version | 32181 | 1 |
| 6540 23 | Flip-up 12M To Be Equipped Version | 34437 | 1 |

INCARA Top Access (Empty)

Easy storage for an office module, Desktop Power Center, Legrand UI with Surface Box DLP with accessories or equivalent product that can accommodate chargers and wires.

Resistance to impacts: IK 07
 Operating temperature: from 5°C to +35°C

For Flush Mounting In Furniture, Compatible Table Thickness 10 To 40

| | | | |
|---------|---------------------------------|-------|---|
| 6548 70 | Top Access 295MM Wide Aluminium | 11033 | 1 |
| 6548 71 | Top Access 295MM Wide White | 12851 | 1 |
| 6548 72 | Top Access 295MM Wide Black | 12332 | 1 |
| 6548 73 | Top Access 395MM Wide Aluminium | 14667 | 1 |
| 6548 74 | Top Access 395MM Wide White | 16420 | 1 |
| 6548 75 | Top Access 395MM Wide Black | 15706 | 1 |

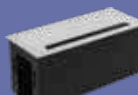

6548 70



6548 73



6548 75

INCARA Pop Up (Empty)

| Cat.Nos | Description | MRP* ₹ / Unit | Pack |
|---------|-------------|------------------|------|
|---------|-------------|------------------|------|

Resistance to Impact: IK 07
 IP 44 for 6 548 12 & IP 20 for the others
 Operating temperature: from 5°C to +35°C
 Conform to standard BS 5733
 Compatible with Arteor accessories, which need to be purchased separately.
 Switch d IS 3854 : 1997
 Sockets IS 1293: 2019
 USB IEC 60950 1
 Switch lasts 100000 & Socket for 10000 plug ins
 Fire resistant up to 850°C for 30 seconds.

For Flush Mounting In Furniture, Compatible Desktop Thickness 15 to 40.

| | | | |
|---------|-----------------------------------|-------|---|
| 6548 45 | Pop-up 3M Brushed Aluminium | 4568 | 1 |
| 6548 46 | Pop-up 3M White | 3714 | 1 |
| 6548 47 | Pop-up 3M Black | 3714 | 1 |
| 6548 48 | Pop-up 3M Aluminium | 3714 | 1 |
| 6548 00 | Pop-up 4M Brushed Aluminium | 5740 | 1 |
| 6548 01 | Pop-up 4M White | 5219 | 1 |
| 6548 02 | Pop-up 4M Black | 5219 | 1 |
| 6548 03 | Pop-up 4M Aluminium | 5219 | 1 |
| 6548 12 | IP 44 Pop-up 4M Brushed Aluminium | 8944 | 1 |
| 6548 08 | Pop-up 8M Brushed Aluminium | 11673 | 1 |
| 6548 09 | Pop-up 8M White | 10613 | 1 |
| 6548 10 | Pop-up 8M Black | 10613 | 1 |
| 6548 11 | Pop-up 8M Aluminium | 10613 | 1 |
| 6548 04 | Pop-up 2x4M Brushed Al | 12257 | 1 |
| 6548 05 | Pop-up 2x4M Wh | 11143 | 1 |
| 6548 06 | Pop-up 2x4M Black | 11143 | 1 |
| 6548 07 | Pop-up 2x4M Al | 11143 | 1 |



6548 46



6548 48



6548 00



6548 01



6548 03



6548 10



6548 04

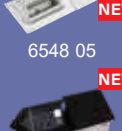

6548 05

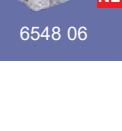

6548 06

* MRP - Maximum Retail Price Inclusive of all taxes including GST.
 Red Cat.Nos - new products

Bold Cat.Nos are products normally available with Legrand (India) Stockists.
 Cat.Nos that are not bold - delivery within 4 - 8 weeks from the date of order.
 Bold packing quantity is our mandatory packing. Orders to be placed by Legrand (India) Stockist in multiples of the same.

NEW!

Desktop Power Center

Practical Power for Modern Workspaces



Desktop Power Center (DPC) brings power and connectivity right to your fingertips. Designed for modern workspaces, it delivers seamless access to power, charging, AV, and data—while keeping desks clean, organized, and clutter-free. Fully customizable with power sockets, USB chargers, and connectivity modules, DPC adapts effortlessly to your workspace needs with style and efficiency

Features

- Modular 6M and 8M configurations with 3-pin 6A sockets and optional USB charging
- Flexible mounting options for on-desk, under-desk, or wall installation
- Child-safe IP20 sockets tested for up to 10,000 plug cycles
- IS-certified switch socket design with maximum load capacity up to 1440 W

Benefits

- Provides convenient power access directly at the workspace
- Keeps desks organised by reducing cable clutter
- Enhances user safety with child-protected outlets
- Simplifies installation with versatile mounting options

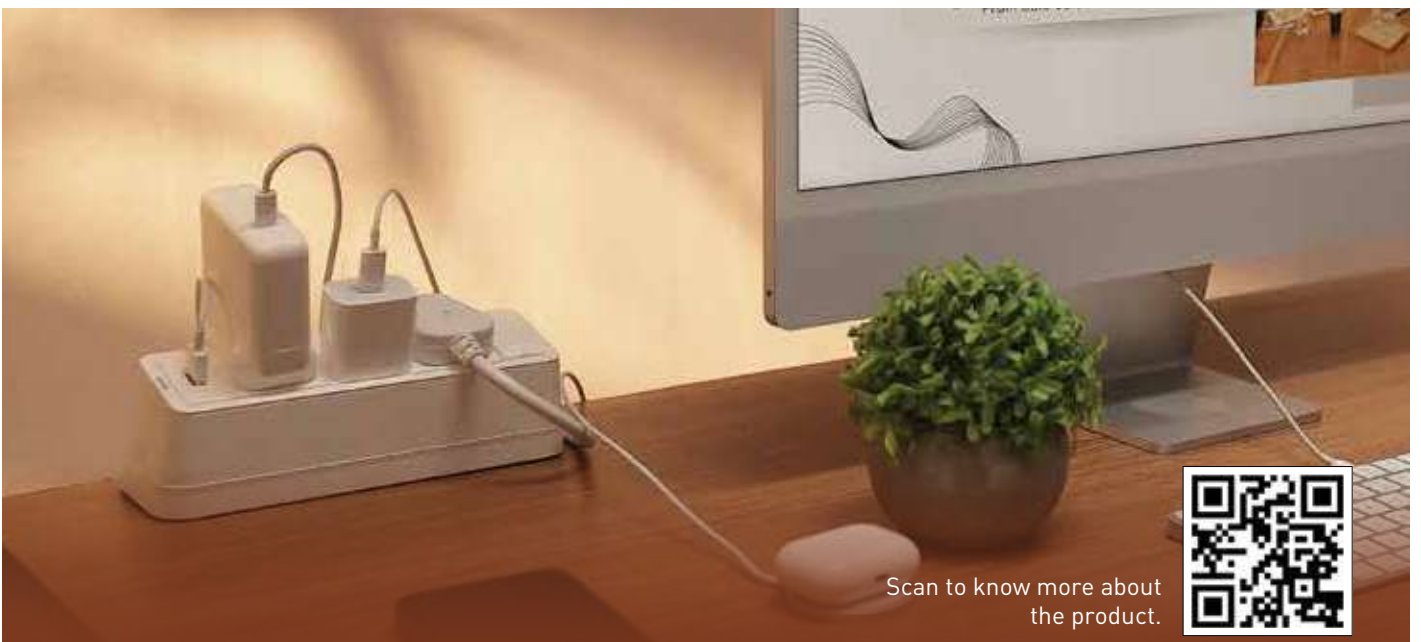

Scan to know more about the product.



Desktop Power Center

| Cat.Nos | Description | MRP* ₹ / Unit | Pack |
|---------|-------------|------------------|------|
|---------|-------------|------------------|------|

Switch IS 3854 : 1997
Sockets IS 1293: 2019
USB IEC 60950 1
Switch lasts 100000 & Socket for 10000 plug ins
Fire resistant up to 850°C for 30 seconds.
Input : 100 240V 50 60Hz/250 mA
Output 5V 1500mA
Power rating 1440W Max
3 PIN Socket 6A 230V IP 20 Rated

Desktop Power Center supplied With L Bracket Kit

1.5 meter cord and a 3 pin plug for easy connection to power

| | | | |
|---------|---------------------|------|---|
| 6550 20 | 6M DPC SKT White | 1348 | 1 |
| 6550 22 | 8M DPC SKT White | 1753 | 1 |
| 6550 24 | 6M DPC SKT ChicGrey | 1660 | 1 |
| 6550 26 | 8M DPC SKT ChicGrey | 2092 | 1 |

Desktop Power Center with USB Type A

| | | | |
|---------|---------------------------|------|---|
| 6550 21 | 6M DPC SKT USB A White | 2159 | 1 |
| 6550 23 | 8M DPC SKT USB A White | 2966 | 1 |
| 6550 25 | 6M DPC SKT USB A ChicGrey | 2495 | 1 |
| 6550 27 | 8M DPC SKT USB A ChicGrey | 3412 | 1 |

Desktop Power Center with USB Type A + C Ports

| | | | |
|-----------|-----------------------------|------|---|
| 6550 21AC | 6M DPC SKT USB A+C White | 3647 | 1 |
| 6550 23AC | 8M DPC SKT USB A+C White | 3861 | 1 |
| 6550 25AC | 6M DPC SKT USB A+C ChicGrey | 3740 | 1 |
| 6550 27AC | 8M DPC SKT USB A+C ChicGrey | 3981 | 1 |

Desktop Power Center

| Cat.Nos | Description | MRP* ₹ / Unit | Pack |
|---------|-------------|------------------|------|
|---------|-------------|------------------|------|

Desktop Power Center (Empty)

To be equipped version of the DPC comes without the cord, installation kit, and accessories. It is compatible with Lyncus accessories, which need to be purchased separately.

| | | | |
|---------|----------------------------------|------|---|
| 6550 30 | 6M DPC (To Be Equipped) White | 673 | 1 |
| 6550 31 | 6M DPC (To Be Equipped) ChicGrey | 774 | 1 |
| 6550 32 | 8M DPC (To Be Equipped) White | 878 | 1 |
| 6550 33 | 8M DPC (To Be Equipped) ChicGrey | 1009 | 1 |

Desktop Power Center DPC Accessories

The accessories come with three installation kits, each containing a different bracket: the Angle L Bracket, Flat I Bracket, and Wall Mount T Bracket. The L Bracket is included with the product, while the I Bracket and T Bracket are available for purchase separately.

| | | | |
|----------|------------------------------------|-----|---|
| 0269 88W | Cord with 3 Pin (BIS) Wh 1.5Mtr | ■ | 1 |
| 0269 88B | Cord with 3 Pin (BIS) Black 1.5Mtr | ■ | 1 |
| 6550 36 | DPC Angle L-Bracket | 163 | 1 |
| 6550 37 | DPC Flat I-Bracket | 149 | 1 |
| 6550 38 | DPC Wall T-Bracket | 218 | 1 |

* MRP - Maximum Retail Price Inclusive of all taxes including GST.
■ Price available on request.

Bold Cat.Nos are products normally available with Legrand (India) Stockists. Cat.Nos that are not bold - delivery within 4 - 8 weeks from the date of order. Bold packing quantity is our mandatory packing. Orders to be placed by Legrand (India) Stockist in multiples of the same.

NEW!

DISQ 60 and DISQ 80

Compact Desk Power for Modern Workspaces



DISQ 60 & DISQ 80 bring smart, desk-integrated power, USB, and data right where you need it. Built for modern workspaces, they blend seamlessly into desks and meeting tables—delivering instant connectivity while keeping surfaces sleek, clean, and clutter-free.

Features

- Circular desk-mounted design for seamless integration into desks and meeting tables
- Integrated power and USB charging for laptops and everyday office devices
- Power sockets compliant with IS 1293 and USB compliant with IS 13252 standards
- Durable construction with IK07 impact resistance for reliable daily use

Benefits

- Provides convenient power and charging access directly at the workspace
- Maintains clean desk aesthetics with minimal visual footprint
- Reduces cable clutter and dependence on external chargers or power strips
- Supports efficient and organised workspaces in offices and meeting rooms



Everything you need.
Right where you work



Disq 60

INCARA DISQ 60 delivers sleek, discreet access to power or USB charging with quick, hassle-free installation.

- Ultimate flexibility – mount horizontally or vertically on any surface, from desks to sofas and lockers, with a patented system that fits even ultra-thin panels (1 mm).



Disq 80

INCARA DISQ 80 combines power, data, and charging in one compact solution for modern, mobile users.

- Ideal for individual workstations, delivering seamless and efficient connectivity.
- Smart retrofit design – easily replaces existing cable outlets (80 mm Ø cut-out).
- Flexible configurations with 6 UTP sockets or cable outlets for quick, hassle-free access.

NEW! Disq 60 and Disq 80

| Cat.Nos | Description | MRP* ₹ / Unit | Pack |
|---------|-------------|------------------|------|
|---------|-------------|------------------|------|

Supply voltage: 250V~
Frequency: 50/60 Hz
Sockets complies with IS 1293
USB complies with IS 13252
Resistance to impact: IK 07
Operating temperature: from -5°C to +35°C
Storage temperature: from -10°C to +70°C



6540 32

6540 32 DISQ 60 1 6A SKT WH 3530 1



6540 29

6540 29 DISQ 60 1 6A SKT BL 3530 1



6540 30

6540 30 DISQ 60 1 USB A+C WH 6270 1



6540 31

6540 31 DISQ 60 1 USB A+C BL 6270 1



6540 33

6540 33 DISQ 80 1 6A SKT USB C 15W CABLE OUTLET WH 6240 1



6540 36

6540 36 DISQ 80 1 6A SKT USB C 15W CABLE OUTLET BL 6240 1

6540 34 DISQ 80 1 6A SKT USB A+C 15W RJ45 CAT6 WH 6550 1



6540 37

6540 37 DISQ 80 1 6A SKT USB A+C 15W RJ45 CAT6 BL 6550 1



6540 39

6540 39 DISQ 80 1 6A SKT USB C 15W CABLE OUTLET BL-METAL 6730 1



6540 40

6540 40 DISQ 80 1 6A SKT USB C 15W RJ45 CAT6 BL-METAL 7070 1

* MRP - Maximum Retail Price Inclusive of all taxes including GST.
Red Cat.Nos - new products

Bold Cat.Nos are products normally available with Legrand (India) Stockists. Cat.Nos that are not bold - delivery within 4 - 8 weeks from the date of order. Bold packing quantity is our mandatory packing. Orders to be placed by Legrand (India) Stockist in multiples of the same.

POP-UP BOXES For Floor

Seamless Floor Design, Superior Protection



Pop-up Boxes for Floor provide discreet floor-mounted access to power, data, and AV connections in modern workspaces. With a slim profile, soft-opening mechanism, and durable construction, they integrate smoothly into floor systems while ensuring reliable connectivity for offices and collaborative environments.

Features

- Extra-slim floor box design with corrosion-resistant, halogen-free construction
- Soft-opening cover with damper and push-slide locking mechanism
- Modular configuration for power, audio, video, and data using Arteor modules
- Robust protection: IP40 rating and IK07 impact resistance for high-traffic areas

Benefits

- Maintains clean floor aesthetics with discreet connectivity access
- Reduces cable clutter by providing power and data at floor level
- Ensures durable performance in high-use commercial environments
- Enhances user convenience with smooth and secure opening operation



Scan to know more about the product.



Pop Up Box

| Cat.Nos | Description | MRP* ₹ / Unit | Pack |
|---------|-------------|------------------|------|
|---------|-------------|------------------|------|

Pop Up Flush Mounting Boxes For Floor To Be Equipped

Installation accessories should be considered additionally along with the pop up box.

For installation, use flush mounting boxes for concrete floors or kits for raised access floors.

To be equipped with Arteor accessories.

3 modules

| | | | |
|---------|---------------------------|------|---|
| 0540 10 | Pop-up 3M Aluminium | 3795 | 1 |
| 0540 15 | Pop-up 3M Brass | 4963 | 1 |
| 0540 20 | Pop-up 3M Stainless Steel | 5015 | 1 |

0540 15

0540 20

4 Modules

| | | | |
|---------|---------------------------|------|---|
| 0540 11 | Pop-up 4M Aluminium | 5094 | 1 |
| 0540 16 | Pop-up 4M Brass | 5872 | 1 |
| 0540 21 | Pop-up 4M Stainless Steel | 6357 | 1 |
| 0540 26 | Pop-up 4M Matt Black | 5650 | 1 |
| 0540 31 | Pop-up 4M Glossy White | 5783 | 1 |

0540 16

0540 21

0540 26

0540 31

6 (2 x 3) Modules

| | | | |
|---------|---------------------------|-------|---|
| 0540 12 | Pop-up 6M Aluminium | 8516 | 1 |
| 0540 17 | Pop-up 6M Brass | 10649 | 1 |
| 0540 22 | Pop-up 6M Stainless Steel | 11042 | 1 |

0540 12

0540 17

0540 22

* MRP - Maximum Retail Price Inclusive of all taxes including GST.

Pop Up Box

| Cat.Nos | Description | MRP* ₹ / Unit | Pack |
|---------|-------------|------------------|------|
|---------|-------------|------------------|------|

8 (2 x 4) Modules

| | | | |
|---------|---------------------------|-------|---|
| 0540 13 | Pop-up 8M Aluminium | 10546 | 1 |
| 0540 18 | Pop-up 8M Brass | 12779 | 1 |
| 0540 23 | Pop-up 8M Stainless Steel | 13595 | 1 |
| 0540 28 | Pop-up 8M Matt Black | 12141 | 1 |
| 0540 33 | Pop-up 8M Glossy White | 12211 | 1 |

0540 18

0540 23

0540 28

0540 33

Installation Kits For Raised Access Floors

Include an empty receptacle and fixing brackets for raised access floor tiles Compatible with:

- Cat. 6 data cabling
- Audio/video cabling

| | | | |
|---------|----------------------------|------|---|
| 0540 05 | Installation Kit 3M Pop-up | 1576 | 1 |
| 0540 06 | Installation Kit 4M Pop-up | 1892 | 1 |
| 0540 07 | Installation Kit 6M Pop-up | 2623 | 1 |
| 0540 08 | Installation Kit 8M Pop-up | 3238 | 1 |

0540 06

For Installation Of Pop-Up Floor Boxes In Concrete Floors

Equipped with knockouts for \varnothing 20 and \varnothing 25 mm conduits

Metal Flush-Mounting Boxes

| | | | |
|---------|-----------------------------|------|---|
| 0540 00 | Back Box Concrete 3M Pop-up | 408 | 1 |
| 0540 01 | Back Box Concrete 4M Pop-up | 540 | 1 |
| 0540 02 | Back Box Concrete 6M Pop-up | 863 | 1 |
| 0540 03 | Back Box Concrete 8M Pop-up | 1085 | 1 |

0540 00

Bold Cat.Nos are products normally available with Legrand (India) Stockists. Cat.Nos that are not bold - delivery within 4 - 8 weeks from the date of order. Bold packing quantity is our mandatory packing. Orders to be placed by Legrand (India) Stockist in multiples of the same.

CABLOFIL®

Most Versatile Cable Tray System



Cablofil® provides wire mesh cable tray systems designed for efficient cable management in power, data, and telecom installations. Engineered from welded steel, the system enables fast installation, flexible routing, and reliable support for modern commercial and industrial infrastructures.

Features

- Wide tray ranges like CF30, CF54, CF105, CF150 in multiple widths and finishes
- Fast assembly system for quick, secure tray connections
- Flexible mounting for overhead, wall, and ceiling installations
- CEI 61537 compliant welded steel construction

Benefits

- Speeds up installation with modular components and simplified assembly
- Ensures safe cable routing with smooth wire mesh construction and reliable support
- Adapts easily to different project requirements
- Supports long-term durability and dependable performance

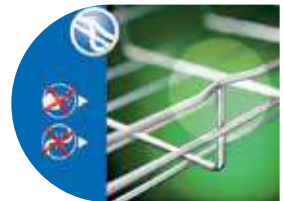

Scan to know more about the product.

*This is a design-and-build product. Design support can be provided as required. Pricing is available upon request and is not included in this price list.

NEW!

SALAMANDRE®

Secure IP4X Overhead Trunking



Salamandre® (MSTR series) is a steel distribution trunking system designed for organized cable routing in commercial and industrial environments. With durable construction and multiple size options, it supports structured power and data distribution while maintaining system reliability and installation efficiency.

Features

- IP4X-rated protection with TORX® security screws and cover straps at joints
- Up to 50% faster installation with pre-installed couplers and Avdel bushes
- Complete fittings range including bends, tees, crossovers, reducers, and end caps
- Multi-compartment steel trunking in sizes from 50×50 mm to 600×150 mm

Benefits

- Prevents unauthorised access with secure, tool-operated lid fixing
- Reduces installation time with pre-assembled components
- Optimises cable routing for power and data distribution systems
- Ensures durable and reliable cable protection

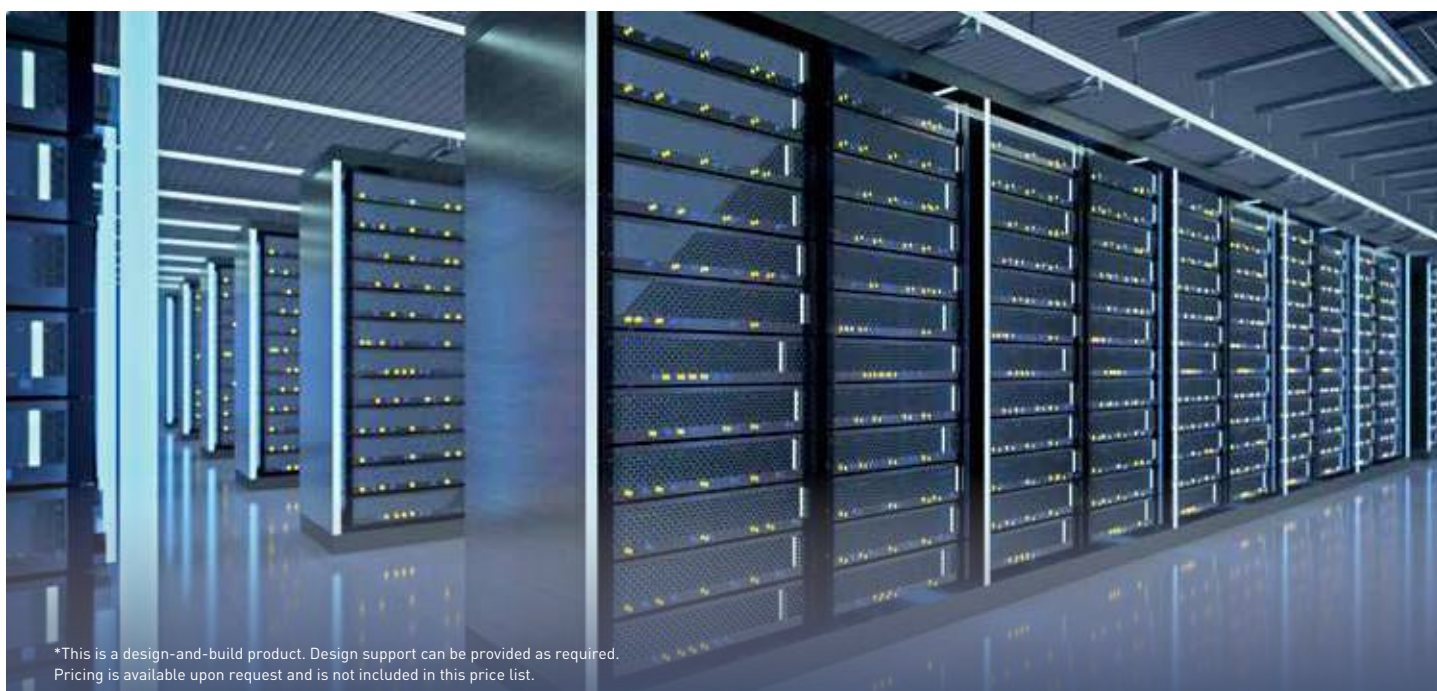

*This is a design-and-build product. Design support can be provided as required. Pricing is available upon request and is not included in this price list.

NEW!

FIBRE RACEWAY

Optimal Fiber Ducting



Fibre Raceway is a modular, high-visibility yellow LSZH ducting system designed for organized fibre routing in data centers and network environments. It supports scalable infrastructure while maintaining clear, structured cable pathways.

Features

- Modular 2 m ducts with snap-fit couplers and routing fittings
- Integrated drop-offs with trumpet outlets and \emptyset 38/50 mm tubing
- Flexible mounting via suspension kits, ladder rack brackets, and cabinet kits
- Certified design (UL94-V0/V1, RoHS, UL2024A) supporting up to 7200 fibre cords

Benefits

- Enables quick network expansion without disturbing existing fibre
- Speeds installation with modular snap-fit components
- Maintains organized routing for reliable fibre management
- Improves safety with LSZH, self-extinguishing recyclable material

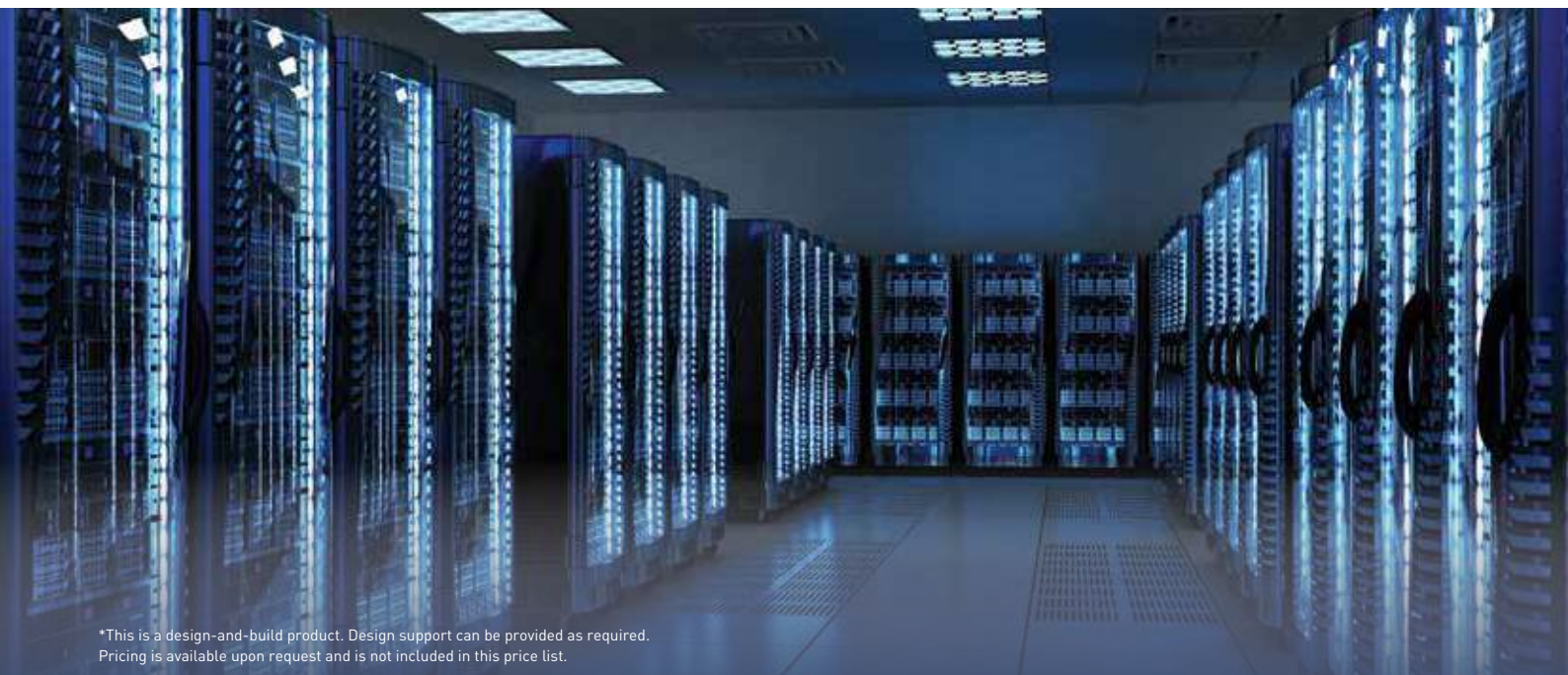

*This is a design-and-build product. Design support can be provided as required. Pricing is available upon request and is not included in this price list.

Floor Solution

| Cat.Nos | Description | MRP* ₹ / Unit | Pack |
|---------|-------------|------------------|------|
|---------|-------------|------------------|------|

Over Floor Trunking

Conform to Std EN 50085-2-2; For creating a link between trunking, column, mini-column, floor units or protecting cables on passageways Supplied with cover

| | | | |
|---------|----------------------------------|------|-------------------|
| 0300 92 | Floor Duct 50X12 | 773 | 54 ⁽¹⁾ |
| 0300 11 | Flat Angle/Floor 50X12 | 345 | 10 |
| 0300 12 | Cover Gasket To Floor 50X12 | 435 | 10 |
| 0300 93 | Floor Duct 75X18 | 1053 | 36 ⁽¹⁾ |
| 0300 18 | Flat Angle/Floor 75X18 | 665 | 10 |
| 0300 19 | Cover Gasket/Floor 50X12 | 461 | 10 |
| 0328 00 | Floor Duct 92X20 | 2201 | 20 ⁽¹⁾ |
| 0328 07 | End Cap For Floor Duct 92x20 | 384 | 10 |
| 0328 03 | Cover Joint For Floor Duct 92x20 | 525 | 10 |
| 0328 02 | Flat Angle For Floor Duct 92x20 | 960 | 5 |

Confirms to EN 50 085 - 2 - 2
Raceways are made from PVC and Galvanised sheet. Compatible with Cat.6 structured cabling system.

Raceways - PVC

Raceways - PVC - Height 38 MM;
Standard Length 2 Meters*; Price Per Meter

| | | | |
|---------|--------------------------|------|----|
| 0896 67 | PVC Raceway 50X38 | 1661 | 12 |
| 0896 68 | PVC Raceway 100X38 2-CMT | 3051 | 16 |
| 0896 69 | PVC Raceway 150X38 3-CMT | 4678 | 10 |

Raceways - Metal / Gi

Raceways - Metal/GI - Height 25 mm; Length 2.44 m.
Price Per Unit (One Unit Is Of 2.44 Meters)

| | | | |
|---------|-----------------------|-------|---------------------|
| 6895 10 | Trunking 50x25 | 2923 | 3/54 ⁽¹⁾ |
| 6895 11 | Trunking 75x25 | 3764 | 3/21 ⁽¹⁾ |
| 6895 12 | Trunking 100x25 | 4570 | 3/54 ⁽¹⁾ |
| 6895 13 | Trunking 150x25 | 6171 | 3/18 ⁽¹⁾ |
| 6895 14 | Trunking 225x25 3-CMT | 9677 | 3/12 ⁽¹⁾ |
| 6895 15 | Trunking 300x25 3-CMT | 12264 | 3/18 ⁽¹⁾ |

Raceways - Metal/GI - Height 38 mm; Length 2.44 m
Price Per Unit (One Unit Is Of 2.44 meters)

| | | | |
|---------|-----------------------|-------|---------------------|
| 6895 00 | Trunking 50x38 | 3394 | 3/54 ⁽¹⁾ |
| 6895 01 | Trunking 75x38 | 4369 | 3/21 ⁽¹⁾ |
| 6895 02 | Trunking 100x38 | 5421 | 3/54 ⁽¹⁾ |
| 6895 03 | Trunking 150x38 | 7269 | 3/36 ⁽¹⁾ |
| 6895 04 | Trunking 225x38 3-CMT | 10741 | 3/12 ⁽¹⁾ |
| 6895 05 | Trunking 300x38 3-CMT | 13474 | 3/18 ⁽¹⁾ |

* MRP - Maximum Retail Price Inclusive of all taxes including GST.

Floor Solution

| Cat.Nos | Description | MRP* ₹ / Unit | Pack |
|---------|-------------|------------------|------|
|---------|-------------|------------------|------|

Floor Raceway Accessories

Fixing Brackets 2 Nos For Each Openable Raceway Length

| | | | |
|---------|-----------------------|-----|---|
| 6897 09 | Fixing Bracket 50X25 | 92 | 9 |
| 6897 10 | Fixing Bracket 75X25 | 102 | 9 |
| 6897 12 | Fixing Bracket 100X25 | 104 | 9 |
| 6897 15 | Fixing Bracket 150X25 | 108 | 9 |
| 6897 20 | Fixing Bracket 225X25 | 151 | 9 |
| 6897 30 | Fixing Bracket 300X25 | 204 | 9 |

Fixing Bracket

| | | | |
|---------|-----------------------|-----|---|
| 6897 27 | Fixing Bracket 50X38 | 102 | 9 |
| 6897 28 | Fixing Bracket 75X38 | 108 | 9 |
| 6897 37 | Fixing Bracket 100X38 | 113 | 9 |
| 6897 38 | Fixing Bracket 150X38 | 128 | 9 |
| 6897 25 | Fixing Bracket 225X38 | 193 | 9 |
| 6897 35 | Fixing Bracket 300X38 | 236 | 9 |

Riser

| | | | |
|---------|------------------------|------|---|
| 6897 23 | Vertical Riser For 225 | 3300 | 1 |
| 6897 33 | Vertical Riser For 300 | 3795 | 1 |

Coupler For Joining Raceways

| | | | |
|---------|-------------|-----|---|
| 6897 77 | Coupling 38 | 204 | 6 |
| 6897 79 | Coupling 25 | 182 | 6 |

Junction Box

For direct access to cables at the intersection of raceways
Supplied completely with base and cover plate (Lid)

Height Adjustable Junction Box 65 - 90 mm

| | | | |
|---------|------------------|------|---|
| 6896 10 | JB150X150X65-90 | 3580 | 1 |
| 6896 11 | JB 225X225X65-90 | 4429 | 1 |
| 6896 12 | JB 300X300X65-90 | 5697 | 1 |
| 6896 13 | JB 400X400X65-90 | 8836 | 1 |

Height Adjustable Junction Box 65 - 90 mm With Fly Over

For direct access to cables at the intersection of floor raceways while maintaining perfect separation and 900 cross overs between data and power cables

| | | | |
|---------|----------------------|------|---|
| 6896 14 | JB FLY 225X225X65-90 | 4783 | 1 |
| 6896 15 | JB FLY 300X300X65-90 | 6515 | 1 |
| 6896 16 | JB FLY 400X400X65-90 | 9546 | 1 |

Height Adjustable Junction Box 50 - 70 mm

| | | | |
|---------|-------------------|------|---|
| 6896 83 | JB 150 X 150 X 50 | 3257 | 1 |
| 6896 84 | JB 225 X 225 X 50 | 3999 | 1 |
| 6896 85 | JB 300 X 300 X 50 | 5203 | 1 |
| 6896 86 | JB 400 X 400 X 50 | 7988 | 1 |

Bold Cat.Nos are products normally available with Legrand (India) Stockists. Cat.Nos that are not bold - delivery within 4 - 8 weeks from the date of order. Bold packing quantity is our mandatory packing. Orders to be placed by Legrand (India) Stockist in multiples of the same.

Floor Solution

| Cat.Nos | Description | MRP* ₹ / Unit | Pack |
|--|------------------------|------------------|------|
| Optional Site Cove for Junction Box | | | |
| 6896 18 | Cover JB 150X150X65-90 | 398 | 10 |
| 6896 19 | Cover JB 225X225X65-90 | 559 | 10 |
| 6896 20 | Cover JB 300X300X65-90 | 860 | 10 |
| 6896 21 | Cover JB 400X400X65-90 | 1290 | 10 |

Selection Chart

| | | | | |
|--|---|----------------------|---|------------------------------|
| Back Box | + | Lid & Trim | + | Support Plate |
| Floor Box for Raised Floor | | | | |
| 6896 38 | + | 689631 | + | 689662/ 689617/ 689678 |
| Floor Box for screed Floor (3 Compartment) | | | | |
| 6896 34 | + | 689631 | + | 689662/ 689617/ 689678 |
| Floor Box for screed Floor (4 Compartment) | | | | |
| 6896 45 | + | 689641 | + | 89662/ 689617/ 689678 |
| Floor box for Tiles/Marble | | | | |
| 0896 04 | + | 689652/689655/689656 | + | 689662/ 689617/ 689678 |
| 50 Reduced Height Floor Box | | | | |
| 0880 73 | + | 088070 | + | 689662/ 689617/ 689678 |

Regular Floor Boxes Range

Floor Boxes for Raised & Screed Floor (3-CMP)

| | | | |
|---------|-------------------------------------|------|---|
| 6896 38 | RF Backbox for 3-CPM (For Carpet) | 6141 | 1 |
| 6896 34 | SF Backbox For 3-CPM (For Carpet) | 9612 | 1 |
| 6896 31 | 265X265 Lid & Trim Carpet 8MM 3-CPM | 4684 | 5 |

Regular Floor Boxes for Screed Floor (4-CMP)

| | | | |
|---------|-------------------|-------|---|
| 6896 45 | Backbox for 4-CPM | 10541 | 1 |
| 6896 41 | Lid & Trim 4-CPM | 5067 | 1 |

Floor Solution

| Cat.Nos | Description | MRP* ₹ / Unit | Pack |
|---------|-------------|------------------|------|
|---------|-------------|------------------|------|

Stainless Steel Insert for Lid

For a metal finish on lid
To be used instead of fitting carpet onto the Lid

| | | | |
|---------|-------------------|------|---|
| 6896 92 | SS Insert For Lid | 5700 | 1 |
|---------|-------------------|------|---|

Floor Boxes for Tile / Marble

| | | | |
|---------|---|-------|---|
| 0896 04 | Backbox (For Tile) | 7917 | 1 |
| 6896 52 | Floor Box Tile 15 To 22MM | 39710 | 1 |
| 6896 55 | Lid/Trim Grey Painted Headband Tile 8 To 15MM | 10891 | 5 |
| 6896 56 | Lid/Trim SS Headband Tile 8 To 15MM | 12520 | 5 |

Reduced Height Vertical Floor Box - 50mm

| | | | |
|---------|----------------------------|-------|---|
| 0880 73 | Back Box (Use With 088070) | 11683 | 1 |
| 0880 70 | Lid & Trim 50 To 70 MM | 11537 | 1 |
| 0880 72 | SS Insert PL For 50MM FB | 7351 | 5 |

Support Plates for Regular Floor Boxes

77 mm with plate

| | | | |
|---------|-------------------------|------|----|
| 689662L | Blank Plate | 497 | 12 |
| 6896 17 | Support Plate Myrius 8M | 532 | 1 |
| 6896 78 | Support Plate Waved | 1538 | 5 |

NEW! Heavy Duty Floor Boxes IP40

| | | | |
|----------------|-------------------------------------|--------|---|
| 0880 80 | Boite encast réglable 55-125 | 19284 | 1 |
| 0880 86 | 4 screws for height extension feets | 3750 | 1 |
| 0880 88 | Foam block for height extension | 8200 | 1 |
| 0896 82 | Heavy load support 15KN | 65750 | 1 |
| 0896 85 | Access trap for junction | 54752 | 1 |
| 0896 86 | Floor box with direct central exit | 116549 | 1 |
| 0896 87 | Cable exit accessory - IP52 | 62273 | 1 |

Bold Cat.Nos are products normally available with Legrand (India) Stockists. Cat.Nos that are not bold - delivery within 4 - 8 weeks from the date of order. Bold packing quantity is our mandatory packing. Orders to be placed by Legrand (India) Stockist in multiples of the same.



6896 38 +
6896 31



6896 34 +
6896 31

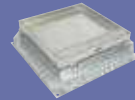

0896 04 +
6896 52

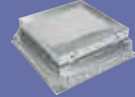

0896 04 +
6896 55



0880 73



0880 70



0880 72



689662L



6896 17



6896 78



0808 80



0808 82



0808 87

Floor Solution

| Cat.Nos | Description | MRP* ₹ / Unit | Pack |
|---------|-------------|------------------|------|
|---------|-------------|------------------|------|

NEW! New Floor Boxes

Plastic Grey Lid and Trim

| | | | |
|----------------|------------------------------------|-------|---|
| 0807 09 | Frame & Lid Plastic Screed 12 M Hz | 6150 | 1 |
| 0807 10 | Frame & Lid Plastic Screed 18 M Hz | 6680 | 1 |
| 0807 11 | Frame & Lid Plastic Screed 24 M Hz | 7970 | 1 |
| 0807 12 | Frame & Lid Plastic Screed 8 M Vt | 7760 | 1 |
| 0807 13 | Frame & Lid Plastic Screed 12 M Vt | 9540 | 1 |
| 0807 14 | Frame & Lid Plastic Screed 16 M Vt | 11340 | 1 |



NEW! Metal SS Finish Lid and Trim

| | | | |
|----------------|----------------------------------|-------|---|
| 0807 27 | Frame & Lid Metal Screed 12 M Hz | 26520 | 1 |
| 0807 28 | Frame & Lid Metal Screed 18 M Hz | 27430 | 1 |
| 0807 29 | Frame & Lid Metal Screed 24 M Hz | 28930 | 1 |
| 0807 30 | Frame & Lid Metal Screed 8 M Vt | 28180 | 1 |
| 0807 31 | Frame & Lid Metal Screed 12 M Vt | 30400 | 1 |
| 0807 32 | Frame & Lid Metal Screed 16 M Vt | 32410 | 1 |



NEW! Flush Metal SS Finish Lid & Trim

| | | | |
|----------------|------------------------------------|-------|---|
| 0807 45 | Flush Concrete Floor 12 Modules Hz | 29450 | 1 |
| 0807 46 | Flush Concrete Floor 18 Modules Hz | 35420 | 1 |
| 0807 47 | Flush Concrete Floor 24 Modules Hz | 36560 | 1 |
| 0807 48 | Flush Concrete Floor 8 Modules Vt | 31000 | 1 |
| 0807 49 | Flush Concrete Floor 12 Modules Vt | 38390 | 1 |
| 0807 50 | Flush Concrete Floor 16 Modules Vt | 39900 | 1 |



Universal Adjustable Backbox

| | | | |
|----------------|-----------------------------|-------|---|
| 0880 80 | Universal Back Box 55-125MM | 19284 | 1 |
|----------------|-----------------------------|-------|---|



Floor Solution

| Cat.Nos | Description | MRP* ₹ / Unit | Pack |
|---------|-------------|------------------|------|
|---------|-------------|------------------|------|

Mounting Adaptors For Screed Floor

| | | | |
|----------------|-----------------------------|------|---|
| 0880 81 | Adaptation Plate for 8/12M | 4173 | 1 |
| 0880 82 | Adaptation Plate for 12/18M | 4512 | 1 |
| 0880 83 | Adaptation Plate for 16/24M | 4830 | 1 |



Auto-Adjusting Backbox

| | | | |
|----------------|-------------------------|------|---|
| 0880 90 | Back Box 8/12M 65-90MM | 5772 | 1 |
| 0880 91 | Back Box 12/18M 65-90MM | 6998 | 1 |
| 0880 92 | Back Box 16/24M 65-90MM | 8213 | 1 |



NEW! Reno Back Box

| | | | |
|----------------|--------------------------------|------|---|
| 0881 90 | Reno Back Box for Std Fb 8/12m | 4650 | 1 |
| 0881 91 | Reno Backbox for Std Fb 12/18m | 5160 | 1 |
| 0881 92 | Reno Backbox for Std Fb 16/24m | 5070 | 1 |



Finish Plates

| | | | |
|---------------|---------------------------|-------|---|
| 088015 | SS Plate Grey Lid 8/12M | 5667 | 1 |
| 088016 | SS Plate Grey Lid 12/18M | 5802 | 1 |
| 088017 | SS Plate Grey Lid 16/24M | 7872 | 1 |
| 088045 | SS Plate Metal Lid 8/12M | 8426 | 1 |
| 088046 | SS Plate Metal Lid 12/18M | 9670 | 1 |
| 088047 | SS Plate Metal Lid 16/24M | 10994 | 1 |



Floor Boxes 3 Module

Conform to EN 50 085 2.2 and EN 60670 23

IP 20/IK07

Compression test, 500N / 1cm² during 1 min :

Comply with norm CEI 60670 23 (2004)

| | | | |
|---------------|-----------------------|------|---|
| 089644 | Floor Box 3M | 2499 | 1 |
| 089649 | Flush Mounting Box 3M | 1663 | 1 |



IP66 Floor Box

IP66 Floor box complies with the IEC 60670 1 and IEC 60670 23 standards.

Resistance to loads: with the cover closed: 10000 N

Resistance to impacts: IK 09 with the cover closed

Self extinguishing : + 650° C / 30 s for parts made of insulating materials.









| | | | |
|---------------|---|-------|---|
| 088061 | IP66/IK09 Screwed SS Floor Box | 27291 | 1 |
| 088064 | IP66/IK09 Hinged CVR SS Floor Box | 32052 | 1 |
| 088069 | Back Box IP66 Floor, Min Screed Height 65 | 5237 | 1 |
| 088062 | IP55 Cable Exit Accessory | 30401 | 1 |
| 089307 | Floor Access Unit Circular | 11683 | 1 |

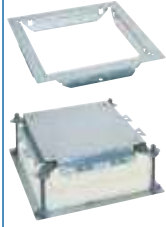

* MRP - Maximum Retail Price Inclusive of all taxes including GST.
Red Cat.Nos - new products

Bold Cat.Nos are products normally available with Legrand (India) Stockists. Cat.Nos that are not bold - delivery within 4 - 8 weeks from the date of order. Bold packing quantity is our mandatory packing. Orders to be placed by Legrand (India) Stockist in multiples of the same.

Frame and Lid Floor Boxes for Concrete Floor Selection Chart

| FLOOR BOX TYPE | FLOOR BOX CAPACITY | FLOOR BOX CAT.NOS | BACKBOX TO SELECT ACCORDING TO CONCRETE SCREED DEPTH | | | | | FINISHING PLATES (OPTIONAL) | | |
|--|--------------------|-------------------|---|---|--|---|---|-----------------------------|----------|----------|
| | | |  |  |  |  |  | | | |
| SOCKETS IN HORIZONTAL POSITION | | | 77 - 90⁽¹⁾⁽²⁾ mm | 80 - 110⁽²⁾ mm | 76 - 125⁽²⁾ mm | 110 - 170 mm | 150 - 250 mm | | | |
|  | 12 (3 x 4) modules | 0 807 09 | 0 880 90 | 0 881 90 | 0 880 80 + 0 880 81 | + | 0 880 88 + 0 880 86 | + | 0 880 88 | 0 880 15 |
| | 18 (3 x 6) modules | 0 807 10 | 0 880 91 | 0 881 91 | 0 880 80 + 0 880 82 | | | | | 0 880 16 |
| | 24 (3 x 8) modules | 0 807 11 | 0 880 92 | 0 881 92 | 0 880 80 + 0 880 83 | | | | | 0 880 17 |
|  | 12 (3 x 4) modules | 0 807 27 | 0 880 90 | 0 881 90 | 0 880 80 + 0 880 81 | | | | | 0 880 45 |
| | 18 (3 x 6) modules | 0 807 28 | 0 880 91 | 0 881 91 | 0 880 80 + 0 880 82 | | | | | 0 880 46 |
| | 24 (3 x 8) modules | 0 807 29 | 0 880 92 | 0 881 92 | 0 880 80 + 0 880 83 | | | | | 0 880 47 |
| SOCKETS IN VERTICAL POSITION | | | 69 - 90⁽¹⁾ mm | 72 - 110 mm | 68 - 125 mm | 110 - 170 mm | 150 - 250 mm | | | |
|  | 8 (2 x 4) modules | 0 807 12 | 0 880 90 | 0 881 90 | 0 880 80 + 0 880 81 | + | 0 880 88 + 0 880 86 | + | 0 880 88 | 0 880 15 |
| | 12 (2 x 6) modules | 0 807 13 | 0 880 91 | 0 881 91 | 0 880 80 + 0 880 82 | | | | | 0 880 16 |
| | 16 (2 x 8) modules | 0 807 14 | 0 880 92 | 0 881 92 | 0 880 80 + 0 880 83 | | | | | 0 880 17 |
|  | 8 (2 x 4) modules | 0 807 30 | 0 880 90 | 0 881 90 | 0 880 80 + 0 880 81 | | | | | 0 880 45 |
| | 12 (2 x 6) modules | 0 807 31 | 0 880 91 | 0 881 91 | 0 880 80 + 0 880 82 | | | | | 0 880 46 |
| | 16 (2 x 8) modules | 0 807 32 | 0 880 92 | 0 881 92 | 0 880 80 + 0 880 83 | | | | | 0 880 47 |

1: From 90 mm to 200 mm with the fixing kit for elevating and leveling Cat.No 0 807 55
2: Minimum dimensions when used with straight plugs





Floor Box

Effortless Access. Seamless Installation.

















- Power and data access closer to the user for maximum convenience
- Quick and easy installation with snap-in design
- Minimal tools required for faster, hassle-free setup

Frame and Lid Floor Boxes for Concrete Floor

Selection Chart

| FLOOR BOX TYPE | FLOOR BOX CAPACITY | FLOOR BOX CAT.NOS | BACKBOX TO SELECT ACCORDING TO CONCRETE SCREED DEPTH | | | | FINISHING PLATES (OPTIONAL) | | |
|---|--------------------|-------------------|--|----------------------------------|---------------------|---------------------|--------------------------------|----------|----------|
| | | | 89 - 90 ⁽¹⁾⁽²⁾ mm | 88 - 122 ⁽²⁾ mm | 110 - 170 mm | 150 - 250 mm | | | |
| SOCKETS IN HORIZONTAL POSITION | | | 89 - 90⁽¹⁾⁽²⁾ mm | 88 - 122⁽²⁾ mm | 110 - 170 mm | 150 - 250 mm | | | |
| METAL FLUSH LID | 12 (3 x 4) modules | 0 807 45 | 0 880 90 | 0 880 80 + 0 880 81 | + | + | 0 881 45 | | |
|  | 18 (3 x 6) modules | 0 807 46 | 0 880 91 | 0 880 80 + 0 880 82 | | | 0 880 88 + 0 880 86 + 0 881 42 | 0 880 88 | 0 881 46 |
| | 24 (3 x 8) modules | 0 807 47 | 0 880 92 | 0 880 80 + 0 880 83 | | | | | 0 881 47 |
| SOCKETS IN VERTICAL POSITION | | | 82 - 90⁽¹⁾ mm | 81 - 122 mm | 110 - 170 mm | 150 - 250 mm | | | |
| METAL FLUSH LID | 8 (2 x 4) modules | 0 807 48 | 0 880 90 | 0 880 80 + 0 880 81 | + | + | 0 881 45 | | |
|  | 12 (2 x 6) modules | 0 807 49 | 0 880 91 | 0 880 80 + 0 880 82 | | | 0 880 88 + 0 880 86 + 0 881 42 | 0 880 88 | 0 881 46 |
| | 16 (2 x 8) modules | 0 807 50 | 0 880 92 | 0 880 80 + 0 880 83 | | | | | 0 881 47 |

Mouting Principle

| | | | | | | | | | | | | | | |
|--|---|---|----|---|----|---|---|---|----|--|----|---|---|---|
|  | = |  | OR |  | OR |  | + |  | OR |  | OR |  | + |  |
| Floor box with sockets in horizontal position | | Type : Standard Frame : Horizontal Lid : Plastic Grey | | Type : Standard Frame : Horizontal Lid : SS Finish | | Type : Flush Frame : Horizontal Lid : SS Finish | | Regular Back Box | | Box (Plastic) (Not compatible with Flush type Lid) | | Universal adjustable Back Box | | Arteor Accessories |
|  | = |  | OR |  | OR |  | + |  | OR |  | OR |  | + |  |
| Floor box with sockets in vertical position | | Type : Standard Frame : Vertical Lid : Plastic Grey | | Type : Standard Frame : Vertical Lid : SS Finish | | Type : Flush Frame : Vertical Lid : SS Finish | | Regular Back Box | | Box (Plastic) (Not compatible with Flush type Lid) | | Universal adjustable Back Box | | Arteor Accessories |

DLP™

Universal & Snap-On Trunking Essentials



DLP™ Trunking is a cable management solution designed for power and data distribution in electrical installations. Compliant with EN 50085-2-1, it supports structured cable routing while accommodating mechanisms such as Arteor.

Features

- Flexible system to adapt to every kind of wall-building configuration
- A new aesthetics, colour : RAL 9003 brilliant white
- A RoHS product = lead free product.
- High resistance against UV to limit the change of the colour during the life of the installation
- Non-Flame Propagating; material : high impact self-extinguishing

Benefits

- Simplifies installation with snap-on covers and clip-on accessories
- Provides flexible cable routing and easy system expansion
- Supports organized separation of power and data circuits
- Ensures durable performance with impact-resistant

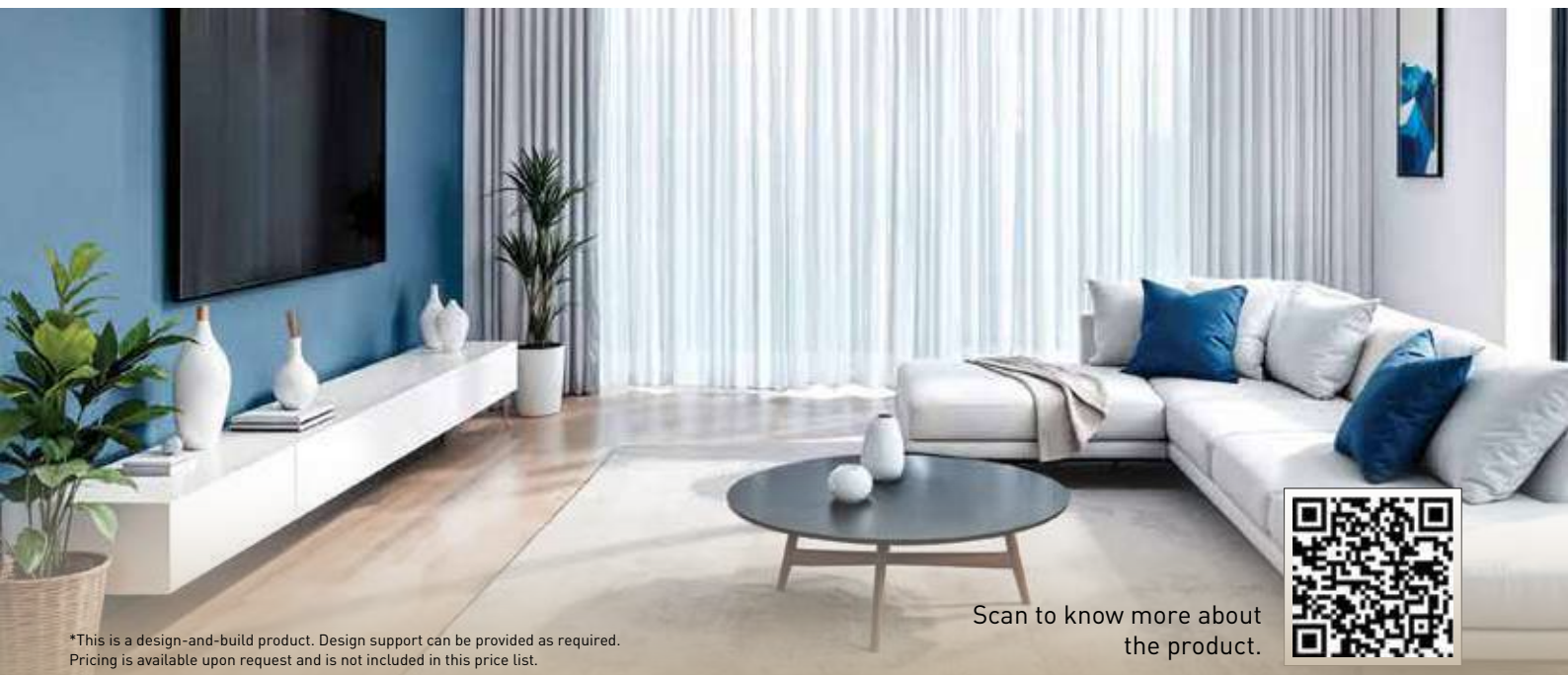

*This is a design-and-build product. Design support can be provided as required. Pricing is available upon request and is not included in this price list.

Scan to know more about the product.



DLP™ Mini-Trunking

Flexible and Aesthetic Cable Management Solution



DLP™ Mini-Trunking offers a practical solution for organized cable routing, protection, and distribution in electrical installations. Its modular design enables neat cable management while supporting easy integration of wiring accessories across residential, commercial, and service environments.

Features

- Flexible system to adapt to every kind of wall-building configuration
- A new aesthetics, colour : RAL 9003 brilliant white
- A RoHS product = lead free product.
- High resistance against UV to limit the change of the colour during the life of the installation
- Non-Flame Propagating; material : high impact self-extinguishing

Benefits

- Simplifies installation with clip-on assembly and easy maintenance access
- Ensures organized cable routing with safe separation of circuits
- Provides durable protection with IP40 enclosure and IK07 impact resistance
- Delivers a clean aesthetic finish suitable for visible installations

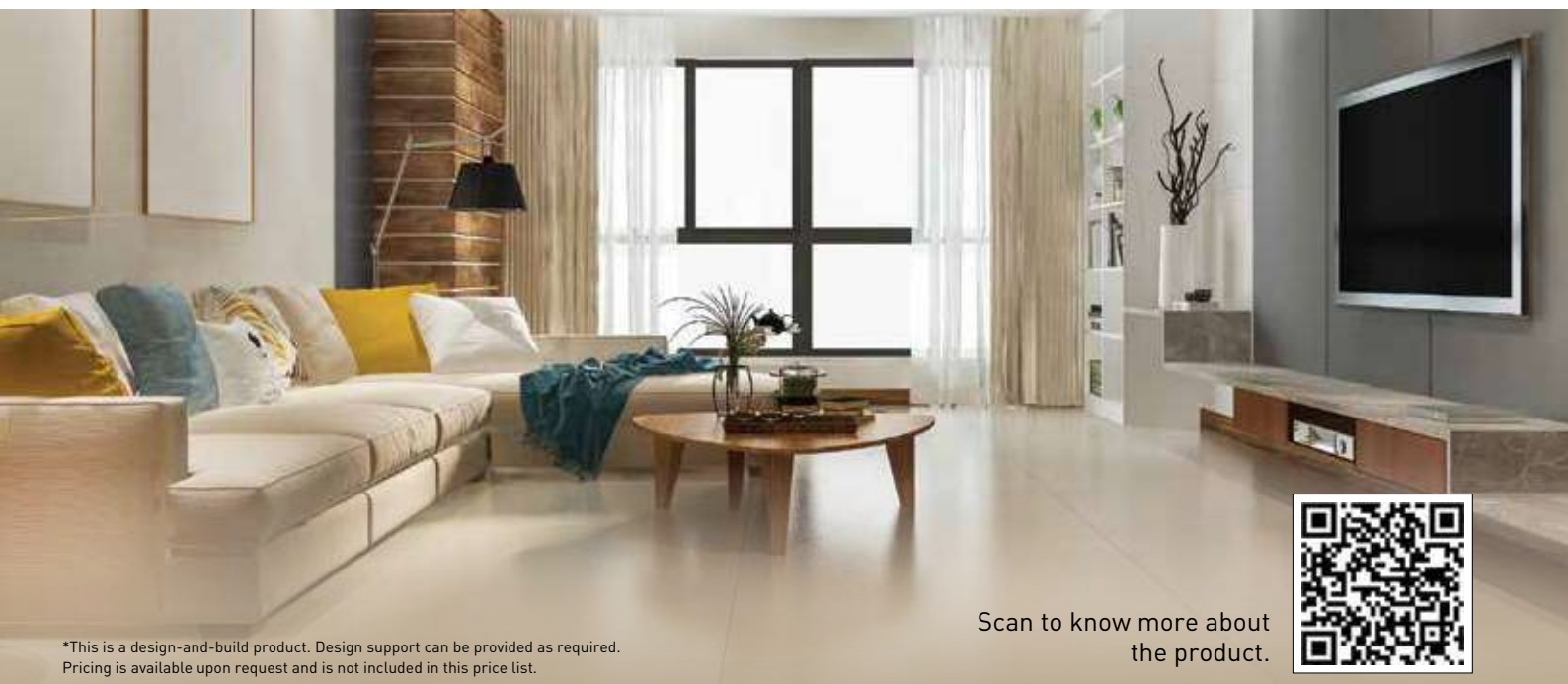

*This is a design-and-build product. Design support can be provided as required. Pricing is available upon request and is not included in this price list.

Scan to know more about
the product.



Snap-on Trunking (Premium) Routing Sections & Accessories

| TRUNKING | | | TRUNKING | | |
|------------------------|-------------|--------------------|--|---------|----------------------|
| Number of compartments | Cover width | Cross-section (mm) | Monobloc: body + cover ⁽¹⁾ | Divider | Fishplate body joint |
| | 45 | 50 x 80 | ○ 0756 01 | 0756 09 | 0756 61 |
| | 45 | 50 x 105 | 0756 02 | 0756 09 | 0756 62 |
| | 45 45 | 50 x 130 | 0756 03 | - | 0756 61 |
| | 45 45 | 50 x 145 | 0756 04 | - | 0756 63 |
| | 45 45 45 | 50 x 180 | 0756 06 | - | 0756 61 |

1: Partition(s) integral to the body
2: Internal and external corner angles supplied with multi-compartment partition joint

Mechanisms for Snap-On Trunking

| Mounting Functions | | |
|---|--|---------|
| The Arteor sockets to be fitted with Soluclip accessory which has following features: - Anti-slip - Anti-pullout - IP 4X - Perfect finish | | 0756 90 |

Installation Principle for Sockets For Snap-On Trunking

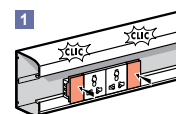

Snap the sockets directly into the trunking

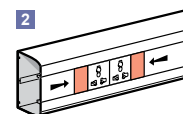

Install the covers

Installation Principle for Arteor Functions

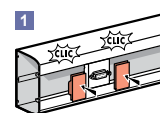

Snap on the mechanism and fix with Soluclips

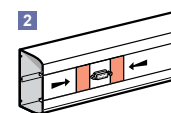

Install the covers

| AND ACCESSORIES | | | ANGLES | | | JUNCTIONS | | | | ACCESSORIES |
|-----------------------------|-------------|---------|--------------------------------|-----------------|-------------|---------------------------------|----------------------------------|--------------------------------|--|-------------|
| Stick-on body joint | Cover joint | End cap | Internal angles ⁽²⁾ | External angles | Flat angles | Flat junctions with width 80 mm | Flat junctions with width 105 mm | Angled junctions 85/105/130 mm | Junction with floor duct 50 x 12/92 x 20 | Extra cover |
| | | | | | | | | | | |
| 0756 66 | 0756 69 | 0756 11 | 0756 21 | 0756 31 | 0756 41 | 0756 71 | - | 0756 81 + 0756 21 | 0756 88 | 0756 08 |
| 0756 67 | 0756 69 | 0756 12 | 0756 22 | 0756 32 | 0756 42 | 0756 72 | 0756 76 | 0756 81 + 0756 22 | 0756 88 | 0756 08 |
| 0756 66 | 2 x 0756 69 | 0756 13 | 0756 23 | 0756 33 | 0756 43 | 0756 71 | 0756 75 | 0756 81 + 0756 23 | 0756 88 | 0756 08 |
| ① 0756 66 + ② 0756 67 | 2 x 0756 69 | 0756 14 | 0756 24 | 0756 34 | 0756 44 | ① 0756 71 + ② 0756 72 | ① 0756 75 + ② 0756 76 | 0756 81 + 0756 24 | 0756 88 | 0756 08 |
| 0756 66 | 3 x 0756 69 | 0756 16 | 0756 26 | 0756 36 | 0756 46 | 0756 71 | 0756 75 | 0756 81 + 0756 26 | 0756 88 | 0756 08 |

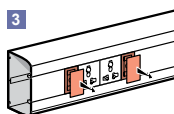

3 Disengage the finishing piece

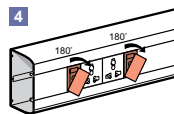

4 Rotate the finishing piece by 180°

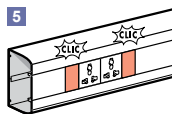

5 Snap on the finishing piece

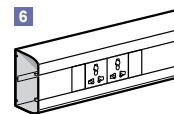

6 An impeccable result

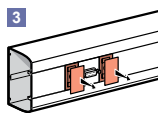

3 Disengage the finishing piece

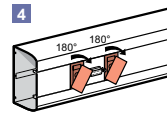

4 Rotate the finishing piece by 180°

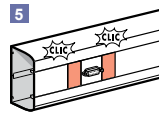

5 Snap on the finishing piece

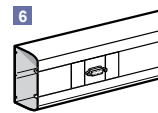



























6 An impeccable result





DLP PVC Universal Adaptable Trunking Systems for Installations

Base, Covers, Partitions, Finishing Accessories & Mounting Wiring Accessories

Selection Chart for Installation Of Trunking, Accessories And Arteor™

| Trunking | | | Covers | | Clip on partition | | Arteor™ frames | | | | |
|---|--|--------------|---|---|---|---|---|---|---|---|---|
| Number of compartments | Cover(s) width | Section (mm) |  |  |  |  |  |  |  |  |  |
| | | | Flexible | Partitions separation | Plastic | Aluminium | 1 module | 2 module | 3 module | 4 module | 6 module |
|  0104 12 | 1 1 x 65  | 80 x 50 | 0105 21 | 0105 82 | - | - | - | 0109 52 | 0109 53 | 0109 54 | 0109 56 |
|  0104 22 | 1 1 x 85  | 105 x 50 | 0105 22 | 0105 82 | - | - | - | 0109 92 | 0109 93 | 0109 94 | 0109 96 |
| | 2 2 x 40  | | 0105 20 | 0105 82 | 0104 72 | 0111 06 | 0109 10 | - | - | - | - |
|  0104 32 | 1 1 x 130  | 150 x 50 | 0105 24 | 0105 82 | - | - | - | - | - | - | - |
| | 2 2 x 65  | | 0105 21 | 0105 82 | 0104 72 | 0111 06 | - | 0109 52 | 0109 53 | 0109 54 | 0109 56 |
| | 2 1 x 40 + 1 x 85  | | 0105 20 + 0105 22 | 0105 82 | 0104 72 | 0111 06 | 0109 10 | 0109 92 | 0109 93 | 0109 94 | 0109 96 |
| | 3 3 x 40  | | 0105 20 | 0105 82 | 0104 72 x 2 | 0111 06 x 2 | 0109 10 | - | - | - | - |
|  0104 52 | 1 1 x 180  | 195 x 50 | 0105 26 | 0105 82 | - | - | - | - | - | - | - |
| | 2 2 x 85  | | 0105 22 | 0105 82 | 0104 72 | 0111 06 | - | 0109 92 | 0109 93 | 0109 94 | 0109 96 |
| | 2 1 x 40 + 1 x 130  | | | 0105 82 | 0104 72 | 0111 06 | 0109 10 | - | - | - | - |
| | 3 1 x 85 + 2 x 40  | | | 0105 82 | 0104 72 x 2 | 0111 06 x 2 | 0109 10 | 0109 92 | 0109 93 | 0109 94 | 0109 62 |
| | 3 1 x 40 + 2 x 65  | | | 0105 82 | 0104 72 x 2 | 0111 06 x 2 | 0109 10 | 0109 52 | 0109 53 | 0109 54 | 0109 56 |
| | 4 4 x 40  | | | 0105 20 | 0105 82 | 0104 72 x 3 | 0111 06 x 3 | 0109 10 | - | - | - |

Selection Chart for Installation Trunking, Accessories And Arteor™

| Section (mm) | Wall crossing  | Capacity change  | Partition junction  | Cable tie base  | Insulating unit for Arteor™ modules  | Earth Link |
|---------------------|--|--|---|--|--|------------|
| 80 x 50 / 105 x 50 | 0106 98 | 0106 87 + 0106 88 + 0106 89 (to be used for partition) | 0106 89 | 0308 81 | 2 Module Combined to get 4/6 Module 0109 27 | 0111 88 |
| 150 x 50 / 195 x 50 | 0106 99 | | | | | |

Selection Chart for Installation Of Trunking, Additional Accessories

| Cover | Bases | | Internal angles 80° - 100° | | | External angles 60° - 120° | | | Flat angles | | Flat junction | | | |
|------------------|------------|----------|----------------------------|--------------------|-------------|----------------------------|--------------------|-------------|-------------|-------------|---------------|--------------------|-------------|---------|
| | | | | | | | | | | | | | | |
| Joint for covers | Base joint | End caps | Angles | Partition junction | VDI access. | Angles | Partition junction | VDI access. | Angles | VDI access. | Angles | Partition junction | VDI access. | Clips |
| 0108 01 | 0106 91 | 0107 22 | 0106 02 | - | 0107 80 | 0106 22 | - | 0107 81 | 0107 67 | 0107 82 | 0107 32 | - | 0107 83 | 0106 82 |
| 0108 02 | 0106 91 | 0107 02 | 0106 02 | - | 0107 80 | 0106 22 | - | 0107 81 | 0107 85 | 0107 82 | 0107 32 | - | 0107 83 | 0106 82 |
| 0108 00 | 0106 91 | 0107 02 | 0106 02 | 0106 11 | - | 0106 22 | 0106 32 | - | - | - | 0107 32 | 0107 42 | - | 0106 82 |
| 0108 04 | 0106 91 | 0107 03 | 0106 02 | - | - | 0106 22 | - | - | 0107 89 | - | 0107 32 | - | - | 0106 86 |
| 0108 01 | 0106 91 | 0107 03 | 0106 02 | 0106 11 | 0107 80 | 0106 22 | 0106 32 | 0107 81 | 0107 89 | 0107 82 | 0107 32 | 0107 42 | 0107 83 | 0106 82 |
| 0108 02 | 0106 91 | 0107 03 | 0106 02 | 0106 11 | 0107 80 | 0106 22 | 0106 32 | 0107 81 | 0107 89 | 0107 82 | 0107 32 | 0107 42 | 0107 83 | 0106 82 |
| 0108 00 | 0106 91 | 0107 03 | 0106 02 | 0106 11 x2 | - | 0106 22 | 0106 32 x2 | - | 0107 89 | - | 0107 32 | 0107 42 | - | 0106 82 |
| 0108 06 | 0106 91 | 0107 07 | 0106 02 | - | - | 0106 22 | - | - | 0107 92 | - | 0107 32 | - | - | 0106 86 |
| 0108 02 | 0106 91 | 0107 07 | 0106 02 | 0106 11 | 0107 80 | 0106 22 | 0106 32 | 0107 81 | 0107 92 | 0107 82 | 0107 32 | 0107 42 | 0107 83 | 0106 82 |
| | 0106 91 | 0107 07 | 0106 02 | 0106 11 | 0107 80 | 0106 22 | 0106 32 | 0107 81 | 0107 92 | 0107 82 | 0107 32 | 0107 42 | 0107 83 | |
| | 0106 91 | 0107 07 | 0106 02 | 0106 11 x2 | 0107 80 | 0106 22 | 0106 32 x2 | 0107 81 | 0107 92 | 0107 82 | 010732 | 0107 42 | 0107 83 | 0106 82 |
| | 0106 91 | 0107 07 | 0106 02 | 0106 11 x2 | 0107 80 | 0106 22 | 0106 32 x2 | 0107 81 | 0107 92 | 010782 | 0107 32 | 0107 42 | 010783 | 0106 82 |
| 0108 00 | 0106 91 | 0107 07 | 0106 02 | 0106 11 x3 | - | 0106 22 | 0106 32 x3 | - | 0107 92 | - | 0107 32 | 0107 42 | - | 0106 82 |

DLP mini trunking systems







For Cable Distribution



Selection Chart for Dlp Mini Trunking

| | Length | Finishing Accessories | | | | Junction Elements | |
|-----------|--------|-----------------------|----------------|----------------|------------|-------------------|---------|
| | | | | | | | |
| WHITE | 2 m | End cap | Internal angle | External angle | Flat angle | Flat junction | |
| 32 x 12.5 | | 0300 15 | 0312 03 | 0302 51 | 0302 51 | 0302 53 | 0302 54 |
| 32 x 16 | | 0308 04 | 0312 07 | 0333 25 | 0333 25 | 0333 27 | 0333 30 |
| 32 x 20 | | 0300 17 | 0312 09 | 0302 71 | 0302 71 | 0302 73 | 0302 74 |

DLP Aluminium Universal Trunking System

Selection Chart of Sections, Covers & Accessories
Selection Chart of Support for Wiring Accessories

| TRUNKING AND ACCESSORIES | | | | | | | | | |
|--------------------------|---|--------------|-----------|--|-------------|--------------|--------------|---|---|
| Width (mm) | Nos. of compartments | Covers width | Cat. nos. | Rigid covers  | | | |  Cover Joint |  Trunking Base Joint |
| | | | | 65 mm width | 85 mm width | 130 mm width | 180 mm width | | |
| 105 x 50 | 1  | 1 x 85 | 111 00 | - | 0111 11 | - | - | 0111 63 | 0111 66 |
| 150 x 50 | 2  | 2 x 65 | 0111 02 | 2 x 0111 10 | - | - | - | 0111 62 | 0111 66 |
| 195 x 50 | 2  | 2 x 85 | 0111 04 | - | 2 x 0111 11 | - | - | 0111 63 | 0111 66 |

| SUPPORT FOR WIRING ACCESSORIES | | |
|---|--------------|---------|
| 60 mm fixing centers : Arteur™ | Cover depths | |
| No of module | 65 mm | 85 mm |
| 2 modules  | 0112 02 | 0112 12 |
| 3 modules  | 0112 03 | 0112 13 |
| 4 modules  | 0112 04 | 0112 14 |
| 6 modules  | 0112 06 | 0112 16 |

Insulation resistance : the entire DLP range, including accessories, have insulation resistance above 5 Megaohms

DLP TRUNKING SYSTEM ALUMINIUM

with Aluminium Adaptable DLP Trunking,
Get Better Styling Too !

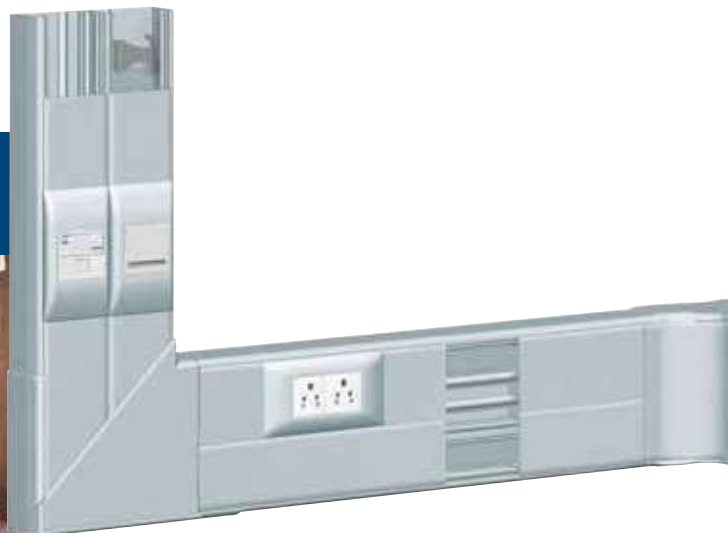

SELECTION CHART OF ACCESSORIES (continued)

| Dividers | | End cap | Internal angles | External angles | Flat angles | Junction Flat junction* | Clips | Earth link |
|-------------------|----------------------|---------|-----------------|-----------------|-------------|----------------------------|---------|------------|
| Clip-on partition | Separation partition | | | | | | | |
| - | 0111 08 | 0111 58 | 0112 21 | 0112 32 | 0112 43 | 0112 51 | 0106 82 | 0111 88 |
| 0111 06 | 0111 08 | 0111 60 | 0112 27 | 0112 38 | 0112 45 | 0112 51 | 0106 82 | 0111 88 |
| 0111 06 | 0111 08 | 0111 61 | 0112 29 | 0112 40 | 0112 47 | 0112 51 | 0106 82 | 0111 88 |

(1) To be used with angle covers. (2) To be used with rigid covers

TABLE OF CAPACITIES

| | Cross-section (mm ²) Max. Ø (mm ²) | 105 x 50 | 150 x 50 | | 195 x 50 | |
|------------------------|---|----------|----------|----------|----------|----------|
| | | cover 85 | cover 65 | cover 65 | cover 85 | cover 85 |
| Trunking only | Cross-section | 4330 | 3020 | 3020 | 5350 | 5350 |
| | Max. Ø | 28 | 43 | 43 | 55 | 55 |
| With Arteor™ / support | Cross-section | 2300 | 1470 | 1470 | 3320 | 3320 |
| | Max. Ø | 2 x 24 | 18 | 18 | 33 | 33 |

*To tap off 105 mm wide trunking with 85 mm cover

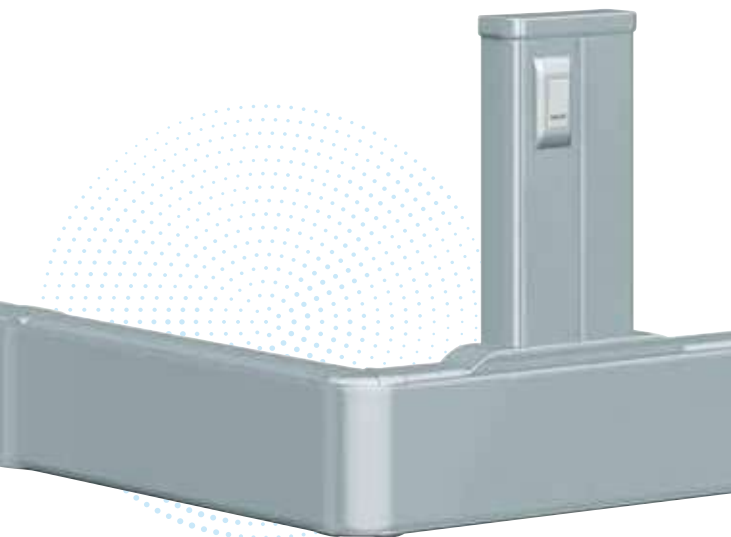

SAVE TIME

- Flexibility : multi-covers
- Removable separation
- Angles delivered pre-cut, ready to use
- Fast fixing device support
- Uniform colours for the entire installation
- Arteor™ wiring accessories go with aluminium adaptable DLP trunking

DLP Snap-On (Premium)

| Cat.Nos | Description | MRP* ₹ / Unit | Pack |
|---------|-------------|------------------|------|
|---------|-------------|------------------|------|

Dlp Snap-On

| | | | |
|---------|---------------------------|------|-------------------|
| 0756 01 | TRK 50X80 1CV45 White 2M | 1650 | 20 ⁽¹⁾ |
| 0756 02 | TRK 50X105 1CV45 White 2M | 2101 | 12 ⁽¹⁾ |
| 0756 03 | TRK 50X130 2CV45 White 2M | 2892 | 12 ⁽¹⁾ |
| 0756 04 | TRK 50X145 2CV45 White 2M | 3741 | 8 ⁽¹⁾ |
| 0756 06 | TRK 50X180 3CV45 White 2M | 4113 | 8 ⁽¹⁾ |

Divider

| | | | |
|---------|---------------------|-----|-------------------|
| 0756 09 | Separation Part TRK | 384 | 26 ⁽¹⁾ |
|---------|---------------------|-----|-------------------|

Extra Cover

| | | | |
|---------|-------------------|-----|-------------------|
| 0756 08 | Flexible CV45 TRK | 645 | 20 ⁽¹⁾ |
|---------|-------------------|-----|-------------------|

Joints

Fishplate Body Joint

| | | | |
|---------|----------------------------|-----|----|
| 0756 61 | Coupling Set 50X80/130/180 | 576 | 10 |
| 0756 62 | Coupling Set 50X105 | 768 | 10 |
| 0756 63 | Coupling Set 50X145 | 840 | 10 |

Stick-On Body Joint

| | | | |
|---------|------------------------------|-----|----|
| 0756 66 | Body Joint 50X80/130/145/180 | 373 | 20 |
| 0756 67 | Body Joint 50X105/145 | 452 | 20 |

Cover Joint

| | | | |
|---------|--------------------|-----|----|
| 0756 69 | 45 Cover Joint TRK | 203 | 10 |
|---------|--------------------|-----|----|

End Caps

| | | | |
|---------|--------------------|-----|----|
| 0756 11 | End Cap TRK 50X80 | 360 | 10 |
| 0756 12 | End Cap TRK 50X105 | 420 | 10 |
| 0756 13 | End Cap TRK 50X130 | 565 | 5 |
| 0756 14 | End Cap TRK 50X145 | 612 | 5 |
| 0756 16 | End Cap TRK 50X180 | 632 | 5 |

Height Spacer

| | | | |
|---------|----------------------------|-----|-------------------|
| 0105 80 | Height Spacer Charcol Grey | 848 | 24 ⁽¹⁾ |
|---------|----------------------------|-----|-------------------|

Soluclip Accessory

Fishplate Body Joint

| | | | |
|---------|--------------|-----|----|
| 0756 90 | Soluclip TRK | 325 | 10 |
|---------|--------------|-----|----|

Angles

Internal Angles

| | | | |
|---------|------------------------|------|----|
| 0756 21 | Inter Angle TRK 50X80 | 768 | 10 |
| 0756 22 | Inter Angle TRK 50X105 | 1074 | 10 |
| 0756 23 | Inter Angle TRK 50X130 | 1808 | 5 |
| 0756 24 | Inter Angle TRK 50X145 | 2904 | 5 |
| 0756 26 | Inter Angle TRK 50X180 | 2577 | 5 |

External Angles

| | | | |
|---------|------------------------|------|----|
| 0756 31 | Exter Angle TRK 50X80 | 1615 | 10 |
| 0756 32 | Exter Angle TRK 50X105 | 2463 | 10 |
| 0756 33 | Exter Angle TRK 50X130 | 3345 | 5 |
| 0756 34 | Exter Angle TRK 50X145 | 3944 | 5 |
| 0756 36 | Exter Angle TRK 50X180 | 4679 | 5 |

Flat Angles

| | | | |
|---------|-----------------------|------|----|
| 0756 41 | Flat Angle TRK 50X80 | 938 | 10 |
| 0756 42 | Flat Angle TRK 50X105 | 1231 | 10 |
| 0756 43 | Flat Angle TRK 50X130 | 2463 | 5 |
| 0756 44 | Flat Angle TRK 50X145 | 2870 | 5 |
| 0756 46 | Flat Angle TRK 50X180 | 4621 | 5 |

DLP

| Cat.Nos | Description | MRP* ₹ / Unit | Pack |
|---------|-------------|------------------|------|
|---------|-------------|------------------|------|

Junctions

Flat Junctions with 80 mm width

| | | | |
|---------|---------------------------|------|---|
| 0756 71 | Flat Junct Side 17 >50X80 | 1288 | 5 |
| 0756 72 | Flat Junct Side 29 >50X80 | 1288 | 5 |

For 105 mm wide Upward Trunking

| | | | |
|---------|----------------------------|------|---|
| 0756 75 | Flat Junct Side 17 >50X105 | 1266 | 5 |
| 0756 76 | Flat Junct Side 29 >50X105 | 1379 | 5 |

Angled Junction

Must be used in conjunction with an internal angle

| | | | |
|---------|--------------------------------|------|---|
| 0756 81 | Angled Junction >50X80/105/130 | 2848 | 5 |
|---------|--------------------------------|------|---|

Junction with Floor Duct

| | | | |
|---------|-----------------------------|------|---|
| 0756 88 | Floor Junction >50X12/92X20 | 1503 | 5 |
|---------|-----------------------------|------|---|

DLP Mini Trunking

Mini-trunking system

Standard length 2 meters; Price per meter
Mini-trunking - 32 x 12.5 mm

| | | | |
|---------|-----------------------|-----|-------------------|
| 0300 15 | Mini TRK 32X125 White | 202 | 80 ⁽¹⁾ |
|---------|-----------------------|-----|-------------------|

Finishing Accessories

| | | | |
|---------|------------------------------|-----|--------|
| 0312 03 | End Cap For 32X125 | 112 | 20/400 |
| 0302 51 | Int/Ext Angle For 32X125 | 154 | 10/100 |
| 0302 53 | Flat Angle For 32X125 | 166 | 10/100 |
| 0302 54 | Flat Junction For 32X125 | 217 | 10/200 |
| 0336 03 | White 32X10/125 Cover Gasket | 218 | 20 |

Mini-Trunking - 32 x 16 mm

| | | | |
|---------|--------------------------|-----|-------------------|
| 0308 04 | Mini TRK 32X16 White 210 | 269 | 60 ⁽¹⁾ |
|---------|--------------------------|-----|-------------------|

Finishing Accessories

| | | | |
|---------|-----------------------------|-----|----|
| 0312 07 | End Cap For 32X16 | 163 | 10 |
| 0333 25 | Int/Ext Angle For 32X16 | 217 | 10 |
| 0333 27 | Flat Angle For 32X16 | 179 | 10 |
| 0333 30 | Flat Junction For 32X16 | 409 | 10 |
| 0336 04 | White 32X16/20 Cover Gasket | 315 | 20 |

Mini-Trunking - 32 x 20 mm

| | | | |
|---------|--------------------------|-----|-------------------|
| 0300 17 | Mini TRK 32X20 White 210 | 352 | 50 ⁽¹⁾ |
|---------|--------------------------|-----|-------------------|

Finishing Accessories

| | | | |
|---------|-----------------------------|-----|----|
| 0312 09 | End Cap For 32X20 | 234 | 10 |
| 0302 71 | Int/Ext Angle For 32X20 | 217 | 10 |
| 0302 73 | Flat Angle For 32X20 | 272 | 10 |
| 0302 74 | Flat Junction For 32X20 | 459 | 10 |
| 0336 04 | White 32X16/20 Cover Gasket | 315 | 20 |

Bold Cat.Nos are products normally available with Legrand (India) Stockists. Cat.Nos that are not bold - delivery within 4 - 8 weeks from the date of order. Bold packing quantity is our mandatory packing. Orders to be placed by Legrand (India) Stockist in multiples of the same.

DLP PVC Universal Trunking

| Cat.Nos | Description | MRP* ₹ / Unit | Pack |
|---------|-------------|------------------|------|
|---------|-------------|------------------|------|

Standard length 2 meters; Price per meter Trunking

Bodies

Supplied without cover

| | | | |
|---------|--------------------|------|-------------------|
| 0104 12 | Plastic TRK 80x50 | 994 | 20 ⁽¹⁾ |
| 0104 22 | Plastic TRK 105x50 | 1243 | 20 ⁽¹⁾ |
| 0104 32 | Plastic TRK 150X50 | 2113 | 10 ⁽¹⁾ |
| 0104 52 | Plastic TRK 195X50 | 2915 | 8 ⁽¹⁾ |

Flexible Cover

Fits onto the whole branch including in internal or external angles

| | | | |
|---------|--------------------------|------|-------------------|
| 0105 20 | Flexible Cover 40 Width | 552 | 20 ⁽¹⁾ |
| 0105 21 | Flexible Cover 65 Width | 580 | 24 ⁽¹⁾ |
| 0105 22 | Flexible Cover 85 Width | 626 | 20 ⁽¹⁾ |
| 0105 24 | Flexible Cover 130 Width | 1209 | 8 |
| 0105 26 | Flexible Cover 180 Width | 1582 | 8 ⁽¹⁾ |

Partitions

| | | | |
|---------|-----------------------------|------|-------------------|
| 0105 82 | Separation Partitions | 328 | 24 ⁽¹⁾ |
| 0104 72 | Clip On Partitions | 486 | 48 ⁽¹⁾ |
| 0111 06 | Aluminium Clip On Partition | 2520 | 12 ⁽¹⁾ |

Joints

| | | | |
|---------|---------------------------|-----|--------|
| 0106 91 | Base Joint | 113 | 20/200 |
| 0108 00 | Joint For 40 Width Cover | 237 | 10/100 |
| 0108 01 | Joint For 65 Width Cover | 267 | 10/100 |
| 0108 02 | Joint For 85 Width Cover | 294 | 10/100 |
| 0108 04 | Joint For 130 Width Cover | 520 | 10/100 |
| 0108 06 | Joint For 180 Width Cover | 602 | 10/100 |

Angles and end caps

Internal and External Angles

Include the 2 components for the top and bottom of the trunking on which the flexible cover is fitted

| | | | |
|---------|--------------------------|-----|-------|
| 0106 02 | Int Angle Adj Frm 80 Deg | 724 | 10/40 |
| 0106 22 | Ext Angle Adj Frm 60 Deg | 723 | 10/50 |

Flat Angle

| | | | |
|---------|-----------------------|------|----|
| 0107 67 | Flat Angle TRK 80X50 | 1028 | 10 |
| 0107 85 | Flat Angle TRK 105X50 | 1074 | 10 |
| 0107 89 | Flat Angle TRK 150X50 | 3571 | 5 |
| 0107 92 | Flat Angle for 195X50 | 4577 | 2 |

End Cap

| | | | |
|---------|--------------------|-----|--------|
| 0107 02 | End Cap TRK 105x50 | 322 | 20/100 |
| 0107 07 | End Cap TRK 195X50 | 610 | 5/50 |
| 0107 22 | End Cap TRK 80X50 | 294 | 10 |
| 0107 03 | End Cap TRK 150x50 | 582 | 10/50 |

Junctions

| | | | |
|---------|--|------|------|
| 0107 32 | Flat Junc. Tap-off to 50mm wide profile | 1333 | 10 |
| 0107 35 | Flat Junc. Tap-off to 80mm wide profile | 780 | 5 |
| 0107 36 | Flat Junc. Tap-off to 105 wide profile with 85mm cover | 768 | 5/25 |
| 0107 37 | Flat Junc. Tap-off to 105 wide profile with 65mm cover | 768 | 5/25 |

* MRP - Maximum Retail Price Inclusive of all taxes including GST.

DLP PVC Universal Trunking

| Cat.Nos | Description | MRP* ₹ / Unit | Pack |
|---------|-------------|------------------|------|
|---------|-------------|------------------|------|

Accessories

Holding Cables in Place

| | | | |
|---------|--------------------------------|-----|----|
| 0106 82 | Clips For 40/65/85 Width cover | 101 | 50 |
| 0106 86 | Clips For 130 Width Cover | 169 | 50 |

VDI Accessories

| | | | |
|---------|----------------------------|------|------|
| 0107 80 | VDI Acc For Int Angle | 1152 | 5/50 |
| 0107 81 | VDI Acc For Flat Ext Angle | 1243 | 5/50 |
| 0107 82 | VDI Acc For Flat Angle | 1322 | 5/50 |
| 0107 83 | VDI Acc For Flat Junction | 1593 | 5/50 |

Additional Accessories

| | | | |
|---------|--------------------------------|------|----------|
| 0106 98 | Wall Crossing for 80/105 x 50 | 1288 | 5/25 |
| 0106 99 | Wall Crossing for 150/195 x 50 | 1333 | 5/25 |
| 0308 81 | Cable Ties Base | 46 | 100/1000 |
| 0111 88 | Earth Link | 485 | 20/500 |

Capacity Change

Allows to increase 15 mm height of trunking to preserve the space of wiring with a flat junction or a support equipment

| | | | |
|---------|--|-----|--------|
| 0106 87 | Capacity Change | 441 | 40 |
| 0106 88 | Capacity Change Set of 4 | 566 | 10/100 |
| 0106 89 | Partition Junction for capacity change | 565 | 5/50 |

Supports for Mounting Wiring Accessories

Arteor™ supports

To be equipped with Arteor socket outlets
Clip-on supports which can be fitted side by side
Supplied with finishing plate

| | | | |
|---------|-------------------------------|-----|--------|
| 0109 10 | 1M Frame For 40 Cover | 480 | 5/50 |
| 0109 52 | 2M Frame For 65 Cover | 506 | 20 |
| 0109 92 | 2M Frame For 85 Cover | 506 | 20 |
| 0109 53 | 3M Frame For 65 Cover | 544 | 5/50 |
| 0109 93 | 3M Frame For 85 Cover | 561 | 5/50 |
| 0109 54 | 4M Frame For 65 Cover | 576 | 10/50 |
| 0109 94 | 4M Frame For 85 Cover | 592 | 20 |
| 0109 56 | 6M Frame For 65 Cover | 444 | 5/25 |
| 0109 96 | 6M Frame For 85 Cover | 630 | 10 |
| 0109 27 | Insu Unit 2M To Create 4/6/8M | 452 | 10/100 |

Legrand Lexic supports

| | | | |
|---------|-----------------------------|------|---|
| 0109 25 | Lex Supp For 2M For DLP 65 | 1570 | 5 |
| 0109 35 | Lex Supp For 3M For DLP 85 | 1853 | 5 |
| 0109 65 | Lex Supp 8M For DLP 130 | 2090 | 5 |
| 0109 00 | Hypra Skt Supp For 130 Cove | 3029 | 5 |

Bold Cat.Nos are products normally available with Legrand (India) Stockists.
Cat.Nos that are not bold - delivery within 4 - 8 weeks from the date of order.
Bold packing quantity is our mandatory packing. Orders to be placed by Legrand (India) Stockist in multiples of the same.

DLP-S Universal Trunking

| Cat.Nos | Description | MRP* ₹ / Unit | Pack |
|---------|-------------|------------------|------|
|---------|-------------|------------------|------|

Standard length 2 meters; Price per meter
Trunking

Body with cover

| | | | |
|---------|---------------------------|------|-------------------|
| 6380 38 | DLP-S TRK+CVR 100X502M | 1435 | 12 ⁽¹⁾ |
|---------|---------------------------|------|-------------------|

Partition

| | | | |
|---------|----------------------------|-----|-------------------|
| 6380 08 | DLP-S Separation Partition | 336 | 32 ⁽¹⁾ |
|---------|----------------------------|-----|-------------------|

Joints

| | | | |
|---------|-------------------------|-----|----|
| 6380 36 | DLP-S Body Joint 100X50 | 160 | 10 |
| 6380 01 | DLP-S Cover Joint 75 | 237 | 50 |

Angles and end caps

Variable angles

| | | | |
|---------|------------------------------------|-----|----|
| 6380 31 | DLP-S Variable Int Angle 100X50 | 700 | 10 |
| 6380 32 | DLP-S Variable Ext Angle 100X50 | 700 | 10 |

Fixed angles

| | | | |
|---------|-------------------------------|-----|----|
| 6380 11 | DLP-S Int Angle For 100X50 | 362 | 20 |
| 6380 12 | DLP-S Ext Angle For 100X50 | 372 | 20 |

Flat angle

| | | | |
|---------|--------------------------------|-----|----|
| 6380 13 | DLP-S Flat Angle For 100X50 | 803 | 16 |
|---------|--------------------------------|-----|----|

End cap

| | | | |
|---------|----------------------|-----|----|
| 6380 35 | DLP-S End Cap 100X50 | 204 | 20 |
|---------|----------------------|-----|----|

Bracket

| | | | |
|---------|--------------------|-----|--------|
| 6380 05 | DLP-S Bracket CV80 | 169 | 10/100 |
|---------|--------------------|-----|--------|

Junction

| | | | |
|---------|------------------|------|---|
| 6380 34 | DLP-S Tee 100X50 | 1763 | 5 |
|---------|------------------|------|---|

Supports for Mounting Wiring Accessories

Arteor™ & Myrius supports

Clip-on supports which can be fitted side by side
Supplied with finishing plate

| | | | |
|---------|-----------------------|-----|----|
| 6380 71 | DLP-S 2 Modules Frame | 440 | 10 |
| 6380 72 | DLP-S 4 Modules Frame | 640 | 5 |
| 6380 73 | DLP-S 6 Modules Frame | 759 | 5 |

DLP Aluminium Universal Trunking

| | | | |
|---------|----------------------------------|-------|------------------|
| 0111 00 | Aluminium TRK 105X50,W/O Cove | 6520 | 8 ⁽¹⁾ |
| 0111 02 | Aluminium TRK 150 X 50 | 8226 | 4 ⁽¹⁾ |
| 0111 04 | Aluminium TRK 195 X 50 | 11942 | 4 ⁽¹⁾ |

Cover & Partition

| | | | |
|---------|------------------------------------|------|-------------------|
| 0111 10 | Aluminium TRK Flexible Cover 65 | 1638 | 16 ⁽¹⁾ |
| 0111 11 | Aluminium Cover 85 Width | 2147 | 16 ⁽¹⁾ |
| 0111 08 | Separation Partition | 1130 | 24 ⁽¹⁾ |
| 0111 06 | Aluminium Clip On Partition | 2520 | 12 ⁽¹⁾ |

Finishing Accessories

| | | | |
|---------|------------------|-----|--------|
| 0111 66 | TRK Body Joint | 476 | 20/100 |
| 0111 62 | Cover Joint 65mm | 531 | 10 |
| 0111 63 | Cover Joint 85mm | 700 | 10/100 |

* MRP - Maximum Retail Price Inclusive of all taxes including GST.

DLP Aluminium Universal Trunking

| Cat.Nos | Description | MRP* ₹ / Unit | Pack |
|---------|-------------|------------------|------|
|---------|-------------|------------------|------|

Finishing Accessories

| | | | |
|---------|--------------------------|-------|--------|
| 0111 58 | End Cap For Al 105X50 | 1164 | 20/100 |
| 0111 60 | End Cap For Al 150X50 | 2486 | 10 |
| 0111 61 | End Cap For Al 195X50 | 2949 | 10 |
| 0112 43 | Flat Angle For 105x50 | 10000 | 10 |
| 0112 45 | Flat Angle For 150x50 | 16837 | 5 |
| 0112 47 | Flat Angle For 195x50 | 17368 | 2 |
| 0112 32 | Ext Angle 50x105 1 Cov85 | 12463 | 1 |
| 0112 38 | Ext Angle 50X150 2 Cov65 | 25809 | 1 |
| 0112 40 | Ext Angle 50X195 2 Cov85 | 26950 | 1 |
| 0112 21 | Int Angle 50x105 1 Cov85 | 11209 | 1 |
| 0112 27 | Int Angle 50X150 2 Cov65 | 25629 | 1 |
| 0112 29 | Int Angle 50X195 2 Cov85 | 26770 | 1 |
| 0112 51 | Flat Junction | 13571 | 5 |

Supports for Arteor™ for Cover 85 mm width

To be equipped with Arteor socket outlets

| | | | |
|---------|----------------------------------|------|----|
| 0112 12 | 2 Arteor Module Frame | 814 | 20 |
| 0112 13 | 3 Arteor Module Frame | 950 | 20 |
| 0112 14 | 4 Arteor Module Frame | 949 | 20 |
| 0112 16 | 6 Module Arteor Frame For DLP | 2260 | 10 |

Supports for Arteor™ for Cover 65 mm width

To be equipped with Arteor socket outlets

| | | | |
|---------|---------------------------------|------|----|
| 0112 02 | 2 Module Arteor Frame For 65 | 734 | 20 |
| 0112 03 | 3 Module Arteor Frame | 904 | 20 |
| 0112 04 | 4 Module Arteor Frame | 938 | 20 |
| 0112 06 | 6 Module Arteor Frame | 1107 | 10 |

Cabling Accessories

| | | | |
|---------|--------------------------|-----|-----|
| 0106 82 | Clips For 40/65/85+Cover | 101 | 50 |
| 0111 88 | Earth Link | 485 | 20 |
| 0308 81 | Cable Ties Base | 46 | 100 |

Bold Cat.Nos are products normally available with Legrand (India) Stockists. Cat.Nos that are not bold - delivery within 4 - 8 weeks from the date of order. Bold packing quantity is our mandatory packing. Orders to be placed by Legrand (India) Stockist in multiples of the same.

Aluminum Snap-on Column

| Cat.Nos | Description | MRP* ₹ / Unit | Pack |
|---------|-------------|------------------|------|
|---------|-------------|------------------|------|

2 Compartments Mini - Columns

| | | | |
|---------|--------------------------------|-------|---|
| 6530 23 | Mini Column 2 Cpts 0.68M White | 17281 | 1 |
| 6530 24 | Mini Column 2 Cpts 0.68M Al | 24409 | 1 |

Accessories for 1 or 2 Compartments Mini- Columns

| | | | |
|---------|--------------------------------|-------|---|
| 6530 84 | Table For Mini Column White | 47795 | 1 |
| 6530 86 | Foot For Mini Column White | 31526 | 1 |
| 6530 87 | Foot For Mini Column Aluminium | 33154 | 1 |
| 6530 88 | 4 Wheels With Cable Holder | 21758 | 1 |

Fixing Clip

| | | | |
|---------|----------------|------|----|
| 6038 57 | Fixing Clip Wh | 373 | 10 |
| 6038 58 | Fixing Clip Al | 1039 | 10 |

1 Compartment - 2 Sides Columns

White Finish

| | | | |
|---------|---------------------------------|-------|---|
| 6530 10 | Snap On Column 1 Cpt 270M White | 45364 | 1 |
| 6530 13 | Snap On Column 1 Cpt 390M White | 58366 | 1 |

Aluminium Finish

| | | | |
|---------|-------------------------------------|-------|---|
| 6530 11 | Snap On Column 1 Cpt 270M Aluminium | 52877 | 1 |
| 6530 14 | Snap On Column 1 Cpt 390M Aluminium | 66506 | 1 |

2 compartments columns

White Finish

| | | | |
|---------|----------------------------------|-------|---|
| 6530 30 | Snap On Column 2 Cpts 270M White | 43934 | 1 |
| 6530 33 | Snap On Column 2 Cpts 390M White | 56749 | 1 |

Aluminium Finish

| | | | |
|---------|--------------------------------------|-------|---|
| 6530 31 | Snap On Column 2 Cpts 270M Aluminium | 58982 | 1 |
| 6530 34 | Snap On Column 2 Cpts 390M Aluminium | 76263 | 1 |

* MRP - Maximum Retail Price Inclusive of all taxes including GST.

Accessories for 1 or 2 compartments

| Cat.Nos | Description | MRP* ₹ / Unit | Pack |
|---------|-------------|------------------|------|
|---------|-------------|------------------|------|

Finishing Kit for Telescopic Pole for 1 or 2 Compartments Columns

| | | | |
|---------|--------------------------------|------|---|
| 6530 66 | White Finishing Kit For Column | 3047 | 1 |
| 6530 67 | Gr Finishing Kit For Column | 3256 | 1 |

Fixing Clip

| | | | |
|---------|----------------|------|----|
| 6038 57 | Fixing Clip Wh | 373 | 10 |
| 6038 58 | Fixing Clip Al | 1039 | 10 |

Snap-On Columns & Mini-Columns:

The natural choice with Arteor wiring accessories



6530 24



Assembled Mini-column with Arteor WDs, Table, movable foot & set of 4 wheels



6530 11



6530 31

AUDIO/VIDEO

Preterminated Sockets

Reliable Connectivity for Modern Spaces

Preterminated audio/video sockets enable seamless connectivity for high-definition audio and video systems. Designed for quick installation and dependable signal transmission, they support professional and residential setups including home theatres, conference rooms, and multimedia environments.

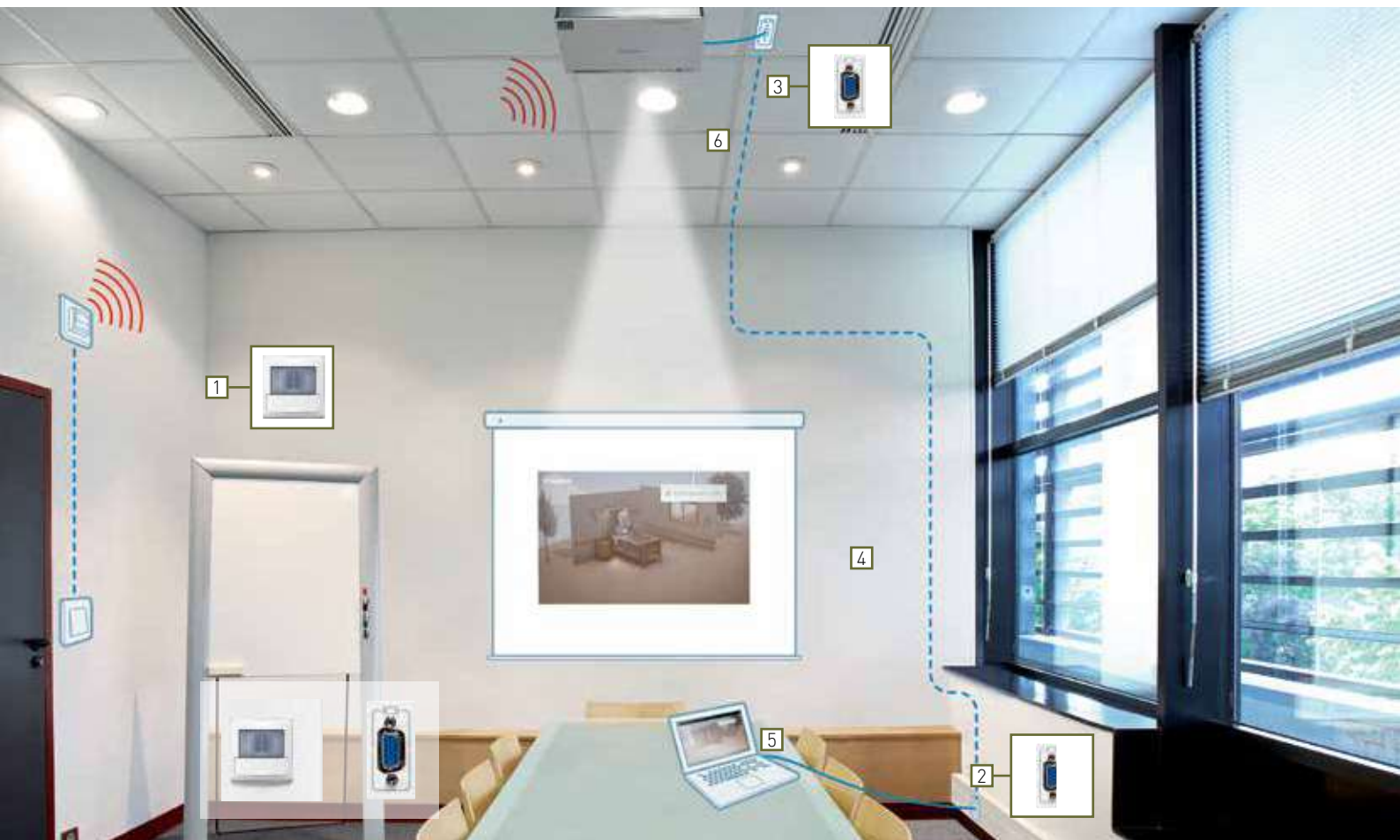

1 Infrared ON/STANDBY control for video projector associated with a pushbutton Cat.No 0 787 99/5 720 89

2 3 Preterminated HD15 sockets Cat.No 0 787 77/5 720 97

4 10 m male/male HD15 cords Cat.No 0 517 23

5 6 Male/male HD 15 cords

Linkeo™

Data Center PDUs

Scalable Power Distribution for Critical IT Infrastructure



Linkeo™ Data Center PDUs deliver scalable and energy-efficient power distribution for IT racks and critical infrastructure. Designed for modern data centers, they support multiple configurations and intelligent monitoring to ensure reliable power management and operational continuity.

Features

- Multiple PDU configurations including Basic, Metered and Switched models
- High-precision power monitoring with $\pm 1\%$ metering accuracy and LCD display
- Secure power connections using C13/C19 outlets with 100N cord locking and hydraulic magnetic MCB protection
- Advanced monitoring and integration with cascading controllers, wireless sensors, and DCIM protocol support

Benefits

- Maximizes uptime with intelligent monitoring and hot-swappable control modules
- Reduces operational complexity through cascading architecture and efficient rack-level management
- Enables greener data center operations with energy-efficient design and minimal packaging
- Enables fast global deployment with 15-day CTO lead times



Scan to know more about the product.

LCS³

Structured Cabling System

Complete Cabling Infrastructure from Room to Workstation



LCS³ is a comprehensive structured cabling solution designed to connect network rooms to workstations with high-speed, reliable infrastructure. Supporting both copper and fibre technologies, it enables scalable network installations for offices, data centers, and enterprise environments.

Features

- Complete structured cabling system connecting network rooms to workstations
- Supports copper cabling from Cat5e to Cat6A (up to 500 MHz) and optical fibre
- Modular copper and high-density fibre panels with integrated cord locking system
- Compatible with Legrand cabling accessories and cable management solutions

Benefits

- Ensures long-term network reliability with a 20-year system warranty
- Delivers high-bandwidth performance for modern data and communication needs
- Enables scalable infrastructure for expanding enterprise networks
- Improves connection security by preventing accidental cable disconnections



Scan to know more about the product.

Micro DC

Integrated Micro Data Center for Edge IT Environments



Legrand Integrated MDC is designed to support IT infrastructure in edge and distributed environments. It provides a secure, space-efficient enclosure that enables reliable IT operations in locations where traditional data center infrastructure is not feasible.

Features

- 42U high-strength rack enclosure with lockable doors, removable vented side panels, and up to 1500 kg load capacity
- Integrated power and cooling systems including UPS, intelligent PDUs, and precision air conditioning
- Advanced monitoring and security with environmental sensors, cameras, access control, and fire protection
- Optimized airflow management using air-seal kits and blanking panels

Benefits

- Accelerates edge IT deployment in remote sites such as warehouses, banks, and branch offices
- Optimizes space utilization with compact, self-contained infrastructure
- Enhances operational reliability through continuous monitoring and controlled environments
- Simplifies infrastructure management with modular architecture and centralized visibility

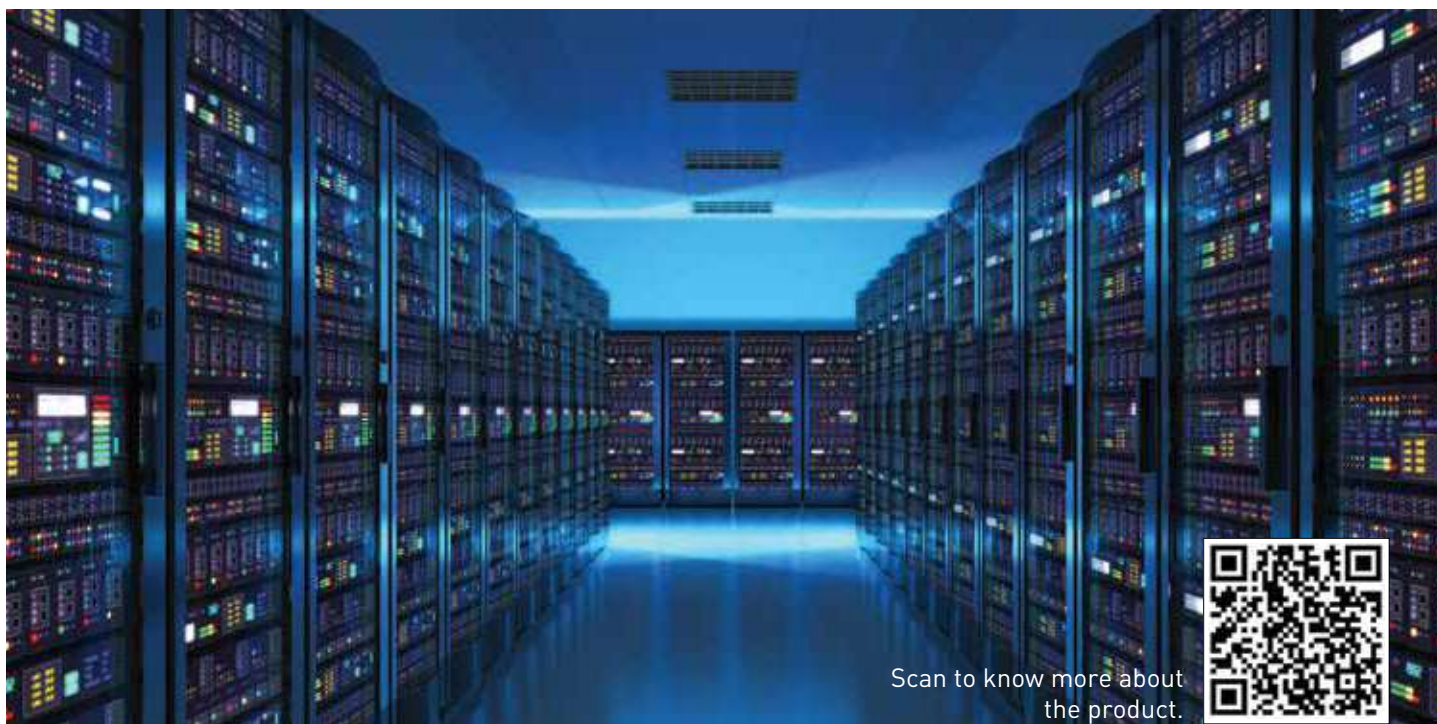

Scan to know more about the product.



LINKEO

Structured Cabling System

Build Reliable Network Connections

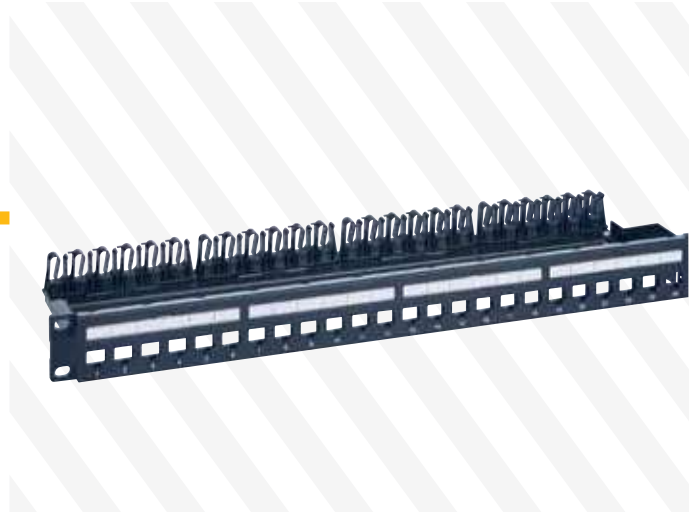

LINKEO™ C is a structured cabling system designed for LAN networks in small and large commercial environments. Featuring ergonomic toolless RJ45 keystone connectors, patch panels, cables, and outlets, it enables fast installation and dependable data performance with a 25-year system warranty.

Features

- Toolless RJ45 keystone connectors with ergonomic lever design for fast termination
- Supports Cat6, and Cat6A UTP cabling up to 10 Gbps
- Pre-positioned patch panels for simplified cable organisation and installation
- Color-coded identification tabs with eco-friendly packaging made from 100% recycled cardboard

Benefits

- Speeds up installation and re-termination with efficient toolless design
- Ensures reliable, high-performance data transmission for enterprise networks
- Simplifies cable management and network organisation in racks and work areas
- Supports sustainable installations with recyclable packaging



Scan to know more about the product.



LCS³ Basic PDU

| Cat.Nos | Description | MRP* ₹ / Unit | Pack |
|----------------------------------|-----------------------------------|------------------|------|
| LCS³ Basic PDU | | | |
| 6468 07 | PDU 19P 6 C19 | ■ | - |
| 6468 09 | PDU 19P 6 C13 + 2 C19 | ■ | - |
| 6468 14 | PDU 19P 10 C13 | ■ | - |
| 6468 15 | PDU 19P 11 C13 | ■ | - |
| 6468 43 | PDU 19P 6 C13 + AMPEREMETRE | ■ | - |
| 6468 44 | PDU 19P 6 C19 + AMPEREMETRE | ■ | - |
| 6468 45 | PDU 19P 6 C13 1 C19 + AMPEREMETRE | ■ | - |
| 6468 56 | PDU 0U 24 C13 + DISJ | ■ | - |
| 6468 57 | PDU 0U 24 C13 + DISJ + CORD | ■ | - |
| 6468 60 | PDU 0U 20C13 + 4C19 + DISJ | ■ | - |
| 6468 61 | PDU 0U 20C13 + 4C19 +DISJ+CORD | ■ | - |
| 6468 65 | PDU 0U 20C13 + 4C19 +DISJ+AMP | ■ | - |
| 6468 70 | PDU 0U TRIPHASE 18C13 + 6C19 | ■ | - |
| 6468 75 | PDU 0U TRI 18C13 + 6C19 +AMP | ■ | - |

LINKEO DC PDU

Single Phase PDU

Basic

| | | | |
|----------|-----------------------------|---|---|
| 6469 71I | PDU HD 1P 32A 24+12 C13/C19 | ■ | - |
| 6469 72I | PDU HD 1P 32A 36+6 C13/C19 | ■ | - |
| 6469 63I | PDU 1P 32A 12+12 C13/C19 | ■ | - |
| 6469 66I | PDU LPM 1P 32A 20+4 C13/C19 | ■ | - |
| 6469 60I | PDU 1P 16A 18+6 C13/C19 | ■ | - |
| 6469 61I | PDU 1 P 16A 20+4 C13/C19 | ■ | - |
| 6469 62I | PDU 1P 32A 20+4 C13/C19 | ■ | - |

Smart Metered

| | | | |
|----------|---------------------------|---|---|
| 6461 00I | MB 19P 1P16A 12 O LCK C20 | ■ | - |
| 6461 01I | MN 19P 1P16A 12 O LCK C20 | ■ | - |
| 6461 02I | MB 0U 1P16A 18+4 LCK IEC | ■ | - |
| 6461 03I | MN 0U 1P16A 18+4 LCK IEC | ■ | - |
| 6461 04I | MB 0U 1P32A 20+4 LCK IEC | ■ | - |
| 6461 05I | MN 0U 1P32A 20+4 LCK IEC | ■ | - |

Smart Metered HD

| | | | |
|----------|------------------------------|---|---|
| 6461 06I | HD MB 0U 1P32A 24+12 LCK IEC | ■ | - |
| 6461 07I | HD MN 0U 1P32A 24+12 LCK IEC | ■ | - |
| 6461 08I | HD MB 0U 1P32A 36+6 LCK IEC | ■ | - |
| 6461 09I | HD MN 0U 1P32A 36+6 LCK IEC | ■ | - |

* MRP - Maximum Retail Price Inclusive of all taxes including GST.

■ Price available on request.

Red Cat.Nos - new products

LINKEO DC PDU

| Cat.Nos | Description | MRP* ₹ / Unit | Pack |
|-----------------------|--------------------------|------------------|------|
| Smart Switched | | | |
| 6461 20I | SB 0U 1P16A 21+3 LCK C20 | ■ | - |
| 6461 21I | SN 0U 1P16A 21+3 LCK C20 | ■ | - |
| 6461 22I | SB 0U 1P32A 20+2 LCK IEC | ■ | - |
| 6461 23I | SN 0U 1P32A 20+2 LCK IEC | ■ | - |
| 6461 24I | SB 0U 1P32A 21+3 LCK IEC | ■ | - |
| 6461 25I | SN 0U 1P32A 21+3 LCK IEC | ■ | - |

Three Phase PDU

Basic

| | | | |
|----------|-------------------------------|---|---|
| 6469 64I | PDU 3P 16A 21+3 C13/C19 | ■ | - |
| 6469 65 | PDU 3P 16A 24+6 C13/C19 IEC | ■ | - |
| 6469 10I | PDU 0U 3P-16A 36C13+6C19 IEC | ■ | - |
| 6469 11I | PDU 0U 3P-16A 24C13+12C19 IEC | ■ | - |

Basic HD PDU

| | | | |
|---------|--------------------------------|---|---|
| 646970I | PDU HD LPM 3P 16A 36+6 C13/C19 | ■ | - |
| 646973I | PDU HD 3P 32A 24+12 C13/C19 | ■ | - |
| 646974I | PDU HD 3P 32A 36+12 C13/C19 | ■ | - |
| 646975 | PDU HD 3P 32A 36+6 C13/C19 | ■ | - |

Smart Metered HD

| | | | |
|----------|------------------------------|---|---|
| 6461 10I | HD MB 0U 3P16A 36+6 LCK IEC | ■ | - |
| 6461 11I | HD MN 0U 3P16A 36+6 LCK IEC | ■ | - |
| 6461 12I | HD MB 0U 3P32A 24+12 LCK IEC | ■ | - |
| 6461 13I | HD MN 0U 3P32A 24+12 LCK IEC | ■ | - |
| 6461 14I | HD MB 0U 3P32A 36+12 LCK IEC | ■ | - |
| 6461 15 | HD MN 0U 3P32A 36+12 LCK IEC | ■ | - |
| 6461 16 | HD MB 0U 3P32A 36+6 LCK IEC | ■ | - |
| 6461 17 | HD MN 0U 3P32A 36+6 LCK IEC | ■ | - |
| 6461 18I | PDU SW BASE 3P 32A 24+12 IEC | ■ | - |
| 6461 19I | PDU SW NODE 3P 32A 24+12 IEC | ■ | - |
| 6461 26I | SB 0U 3P16A 21+3 LCK IEC | ■ | - |
| 6461 27I | SN 0U 3P16A 21+3 LCK IEC | ■ | - |
| 6461 28I | SB 0U 3P16A 24+6 LCK IEC | ■ | - |
| 6461 29I | SN 0U 3P16A 24+6 LCK IEC | ■ | - |

Bold Cat.Nos are products normally available with Legrand (India) Stockists. Cat.Nos that are not bold - delivery within 4 - 8 weeks from the date of order. Bold packing quantity is our mandatory packing. Orders to be placed by Legrand (India) Stockist in multiples of the same.

Power Cords

| Cat.Nos | Description | MRP* ₹ / Unit | Pack |
|-------------------------------------|--------------------------------|------------------|------|
| Power Cords C14 to C13 Plugs | | | |
| 6441 00 | 10 CORDS C14-C13 LOCK 0.5M BLK | ■ | 1 |
| 6441 01 | 10 CORDS C14-C13 LOCK 1M BLK | ■ | |
| 6441 02 | 10 CORDS C14-C13 LOCK 1.5M BLK | ■ | |
| 6441 03 | 10 CORDS C14-C13 LOCK 2M BLK | ■ | |
| 6441 06 | 10 CORDS C14-C13 LOCK 0.5M RED | ■ | |
| 6441 07 | 10 CORDS C14-C13 LOCK 1M RED | ■ | |
| 6441 08 | 10 CORDS C14-C13 LOCK 1.5M RED | ■ | |
| 6441 09 | 10 CORDS C14-C13 LOCK 2M RED | ■ | |
| 6441 12 | 10 CORDS C14-C13 LOCK 0.5M BLU | ■ | |
| 6441 13 | 10 CORDS C14-C13 LOCK 1M BLU | ■ | |
| 6441 14 | 10 CORDS C14-C13 LOCK 1.5M BLU | ■ | |
| 6441 15 | 10 CORDS C14-C13 LOCK 2M BLU | ■ | |

Power Cords C20 to C19 Plugs

| | | | |
|---------|--------------------------------|---|--|
| 6442 01 | 10 CORDS C20-C19 LOCK 1M BLK | ■ | |
| 6442 02 | 10 CORDS C20-C19 LOCK 1.5M BLK | ■ | |
| 6442 03 | 10 CORDS C20-C19 LOCK 2M BLK | ■ | |
| 6442 07 | 10 CORDS C20-C19 LOCK 1M RED | ■ | |
| 6442 08 | 10 CORDS C20-C19 LOCK 1.5M RED | ■ | |
| 6442 09 | 10 CORDS C20-C19 LOCK 2M RED | ■ | |
| 6442 13 | 10 CORDS C20-C19 LOCK 1M BLU | ■ | |
| 6442 14 | 10 CORDS C20-C19 LOCK 1.5M BLU | ■ | |
| 6442 15 | 10 CORDS C20-C19 LOCK 2M BLU | ■ | |

Accessories

| | | | |
|---------|-------------------------------|---|--|
| 6461 30 | NODE CONTROLLER | ■ | |
| 6469 05 | POWER CABLE, C19 TO IEC, 1.5M | ■ | |
| 6469 06 | POWER CABLE, C19 TO IEC, 3M | ■ | |
| 6468 94 | 6 OBTURATEURS C13 + CLE | ■ | |
| 6468 95 | 6 OBTURATEURS C19 + CLE | ■ | |

Wireless Sensors

| | | | |
|---------|--------------------------------|---|--|
| 6460 03 | WIRELESS T/H SENSOR | ■ | |
| 6460 04 | WIRELESS CONTACTCLOSURE SENSOR | ■ | |
| 6460 05 | EMMETTEUR USB CAPTEURS SSFIL | ■ | |
| 6460 06 | EXTERNAL FIXING PLATES X20 | ■ | |
| 6339 10 | POWER STRIP 19 INCH WITH MCB | ■ | |

* MRP - Maximum Retail Price Inclusive of all taxes including GST.
 ■ Price available on request.
 Red Cat.Nos - new products

Legrand Cabling System Linkeo C Category 6 & 6_A

| Cat.Nos | Description | MRP* ₹ / Unit | Pack |
|---------|-------------|------------------|------|
|---------|-------------|------------------|------|

Linkeo C 19" Unloaded Patch Panel to be Equipped with 24 RJ 45 Connectors

| | | | |
|---------|--------------------------|---|--|
| 6328 50 | 19" Unloaded Patch panel | ■ | |
|---------|--------------------------|---|--|

Linkeo C Keystone Connectors

Cat. 6 RJ 45 Connectors

| | | | |
|---------|-------------------------|---|--|
| 6329 09 | RJ45 CAT 6 UTP KEYSTONE | ■ | |
|---------|-------------------------|---|--|

Cat. 6A RJ 45 Connectors

| | | | |
|---------|--------------------------|---|--|
| 6329 06 | RJ45 CAT 6A UTP KEYSTONE | ■ | |
|---------|--------------------------|---|--|

Linkeo C Keystone Faceplates

RJ 45 Linkeo Faceplates

| | | | |
|---------|--------|---|--|
| 6327 94 | 1 PORT | ■ | |
| 6327 95 | 2 PORT | ■ | |
| 6329 00 | 4 PORT | ■ | |

Angled RJ 45 Linkeo Faceplates

| | | | |
|---------|--------|---|--|
| 6327 96 | 1 PORT | ■ | |
| 6327 97 | 2 PORT | ■ | |

Legrand cabling system LCS³ Category 6

Marking Kit

| | | | |
|---------|---|---|---|
| 0518 90 | Kit of 200 coloured rings for marking RJ 45 cords Rings to be clipped to the patch cords | ■ | 1 |
|---------|---|---|---|



Legrand cabling system LCS³ Category 6_A

Cat. 6_A Patch Panels Equipped with 24 RJ 45 Connectors

Flat panels

24 RJ 45 connectors - 1 U

| | | | |
|---------|-----|---|---|
| 0337 70 | UTP | ■ | 1 |
| 0337 72 | STP | ■ | 1 |



Flat 24-Connector Patch Panels - 1 U to be Equipped

Flat panel with empty cassettes to be equipped with connectors

Equipped with 4 automatic extraction cassettes for cat. 5e to cat. 8 RJ 45 connectors

| | | | |
|---------|-----------------|---|---|
| 0337 90 | 19" panel - 1 U | ■ | 1 |
|---------|-----------------|---|---|



Bold Cat.Nos are products normally available with Legrand (India) Stockists. Cat.Nos that are not bold - delivery within 4 - 8 weeks from the date of order. Bold packing quantity is our mandatory packing. Orders to be placed by Legrand (India) Stockist in multiples of the same.

Legrand Cabling System LCS³ Category 6_A

| Cat.Nos | Description | MRP* ₹ / Unit | Pack |
|---------|-------------|------------------|------|
|---------|-------------|------------------|------|

Empty flat panel to be equipped with cassettes

It can accept a maximum of 4 automatic extraction cassettes:
- copper
- fibre optic

| | | | |
|---------|-----------------|---|---|
| 0337 91 | 19" panel - 1 U | ■ | 1 |
|---------|-----------------|---|---|

Flat High Density 48-Connector Patch Panel - 1 U to be equipped

| | | | |
|---------|-----------------|---|---|
| 0337 93 | 19" panel - 1 U | ■ | 1 |
|---------|-----------------|---|---|

Angled 24-Connector Patch Panel - 1 U

Angled panel to be equipped with connectors

It can accept up to 24 cat. 5e to cat. 8 RJ 45 connectors

| | | | |
|---------|-----------------|---|---|
| 0337 92 | 19" panel - 1 U | ■ | 1 |
|---------|-----------------|---|---|

Angled High Density 48-Connector Patch Panel - 1 U To Be Equipped

Angled panel to be equipped with connectors

It can accept up to 48 cat. 5e to cat. 6A RJ 45 connectors

| | | | |
|---------|-----------------|---|---|
| 0337 94 | 19" panel - 1 U | ■ | 1 |
|---------|-----------------|---|---|

High Density Cat. 6a RJ 45 Connectors

| | | | |
|---------|-----|---|---|
| 0337 73 | UTP | ■ | 1 |
| 0337 75 | STP | ■ | 1 |

Common Accessories for Flat & Angled Panels

Port Blanking Modules

| | | | |
|---------|---|---|----|
| 0337 56 | Divisible 6 port blanking plate for sealing from 1 to 6 ports | ■ | 10 |
|---------|---|---|----|

Cord Management

| | | | |
|---------|--|---|---|
| 0337 59 | For use with new generation Quick-Fix; they provide side cord management | ■ | 1 |
|---------|--|---|---|

Specific Accessories for Flat Panels

Cassette For Flat Panels to be Equipped

| | | | |
|---------|--|---|---|
| 0337 55 | Empty removable cassette to be equipped with connectors. It can accept 6 cat. 5e to cat. 8 connectors Extraction by simple pressure of the cassette making installation and maintenance easier Possibility of removing each connector individually | ■ | 1 |
|---------|--|---|---|

High Density Cassette for Flat Panels to be Equipped

| | | | |
|---------|--|---|---|
| 0337 95 | Empty removable cassette to be equipped with connectors; it can accept 12 cat. 5e to cat. 6 _A connectors Extraction by simple pressure of the cassette, making installation and maintenance easier | ■ | 1 |
|---------|--|---|---|

* MRP - Maximum Retail Price Inclusive of all taxes including GST.
■ Price available on request.



0337 93



0337 92



0337 94



0337 75



0337 56



0337 59



0337 55

Legrand Cabling System LCS³ Category 6_A

| Cat.Nos | Description | MRP* ₹ / Unit | Pack |
|---------|-------------|------------------|------|
|---------|-------------|------------------|------|

Blanking Cassette

| | | | |
|---------|-------------------------|---|---|
| 0337 57 | Used to blank the panel | ■ | 1 |
|---------|-------------------------|---|---|

Specific Accessories for Angled Panels

Angled Panel Cover

| | | | |
|---------|---|---|---|
| 0337 58 | For optimised management of the air flow inside the cabinet | ■ | 1 |
|---------|---|---|---|

Cables for Local Networks Cat. 6A

F/UTP - 4 Pairs

Performance 500 MHz

| | | | |
|---------|---|---|------------------|
| 0327 78 | Length 500 m Supplied on reel. Weight 25 kg | ■ | 500 ¹ |
|---------|---|---|------------------|

F/UTP - 2 x 4 Pairs

Performance 500 MHz

| | | | |
|---------|--|---|------------------|
| 0328 78 | Length 500 m Supplied on reel. Weight 65 kg | ■ | 500 ¹ |
|---------|--|---|------------------|

S/FTP - 4 Pairs

Performance 600 MHz

| | | | |
|---------|--|---|------------------|
| 0327 77 | Length 500 m Supplied on reel. Weight 30 kg | ■ | 500 ¹ |
|---------|--|---|------------------|

RJ 45 Patch Cords & User Cords Cat. 6A

PVC - U/UTP Unscreened Impedance 100 Ω

| | | | |
|---------|------------|---|---|
| 0518 82 | Length 1 m | ■ | 1 |
| 0518 83 | Length 2 m | ■ | 1 |
| 0518 84 | Length 3 m | ■ | 1 |
| 0518 85 | Length 5 m | ■ | 1 |

LSZH - U/UTP Unscreened Impedance 100 Ω

| | | | |
|---------|------------|---|---|
| 0518 78 | Length 1 m | ■ | 1 |
| 0518 79 | Length 2 m | ■ | 1 |
| 0518 80 | Length 3 m | ■ | 1 |
| 0518 81 | Length 5 m | ■ | 1 |
| 0518 74 | Length 1 m | ■ | 1 |
| 0518 75 | Length 2 m | ■ | 1 |
| 0518 76 | Length 3 m | ■ | 1 |
| 0518 77 | Length 5 m | ■ | 1 |



0337 57



0337 58

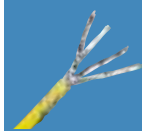

0327 77



0517 82

Bold Cat.Nos are products normally available with Legrand (India) Stockists. Cat.Nos that are not bold - delivery within 4 - 8 weeks from the date of order. Bold packing quantity is our mandatory packing. Orders to be placed by Legrand (India) Stockist in multiples of the same.

Legrand Cabling System LCS³ Category 6_A

| Cat.Nos | Description | MRP* ₹ / Unit | Pack |
|---|--------------|------------------|------|
| PVC - S/FTP Shielded Impedance 100 Ω | | | |
| 0518 16 | Length 0.5 m | ■ | 1 |
| 0517 80 | Length 1 m | ■ | 5 |
| 0517 81 | Length 2 m | ■ | 5 |
| 0517 82 | Length 3 m | ■ | 5 |
| 0517 83 | Length 5 m | ■ | 5 |

| Cat.Nos | Description | MRP* ₹ / Unit | Pack |
|--|-------------|------------------|------|
| LSZH - S/FTP Shielded Impedance 100 Ω | | | |
| 0518 70 | Length 1 m | ■ | 1 |
| 0518 71 | Length 2 m | ■ | 1 |
| 0518 72 | Length 3 m | ■ | 1 |
| 0518 73 | Length 5 m | ■ | 1 |
| 0518 66 | Length 1 m | ■ | 1 |
| 0518 67 | Length 2 m | ■ | 1 |
| 0518 68 | Length 3 m | ■ | 1 |
| 0518 69 | Length 5 m | ■ | 1 |

Arteor RJ 45 Socket Cat. 6_A

360° Metal Shielding

STP - 1 Module

| | | | |
|---------|-------------------------------|---|----|
| 5734 32 | White | ■ | 20 |
| 5728 06 | Magnesium | ■ | 10 |
| 5723 52 | White with green shutter | ■ | 10 |
| 5728 52 | Magnesium with green shutter | ■ | 10 |
| 5723 51 | White with orange shutter | ■ | 10 |
| 5728 51 | Magnesium with orange shutter | ■ | 10 |

STP with Controlled Access - 2 Modules

Supplied with 2 Keys for 5 Sockets

| | | | |
|---------|----------------------------|---|---|
| 5723 50 | White with Red Shutter | ■ | 5 |
| 5728 50 | Magnesium with Red Shutter | ■ | 5 |



5734 32

Legrand Cabling System LCS³ Category 6_A

| Cat.Nos | Description | MRP* ₹ / Unit | Pack |
|-----------------------|-------------------------------|------------------|------|
| UTP - 1 module | | | |
| 5723 49 | White | ■ | 10 |
| 5728 49 | Magnesium | ■ | 10 |
| 5723 59 | White with Green Shutter | ■ | 10 |
| 5728 59 | Magnesium with Green Shutter | ■ | 10 |
| 5723 58 | White with Orange Shutter | ■ | 10 |
| 5728 58 | Magnesium with Orange Shutter | ■ | 10 |

UTP with Controlled Access - 2 modules

Supplied with 2 keys for 5 sockets

| | | | |
|---------|----------------------------|---|---|
| 5723 57 | White with Red Shutter | ■ | 5 |
| 5728 57 | Magnesium with Red Shutter | ■ | 5 |



5723 57



0337 93



0337 61



0337 94



0337 63



0337 56



0337 59



0337 55

Legrand Cabling System LCS³ Category 6

Cat. 6 Patch Panels Equipped with 24 RJ 45 Connectors

Flat panels

24 RJ 45 connectors - 1 U

| | | | |
|---------|-----|---|---|
| 0337 60 | UTP | ■ | 1 |
| 0337 61 | FTP | ■ | 1 |
| 0337 62 | STP | ■ | 1 |

Flat 24-Connector Patch Panels - 1 U to be Equipped

Flat panel with empty cassettes to be equipped with connectors

Equipped with 4 automatic extraction cassettes for cat. 5e to cat. 8 RJ 45 connectors

| | | | |
|---------|-----------------|---|---|
| 0337 90 | 19" Panel - 1 U | ■ | 1 |
|---------|-----------------|---|---|

Empty flat panel to be equipped with cassettes

It can accept a maximum of 4 automatic extraction cassettes:
- copper
- fibre optic

| | | | |
|---------|-----------------------|---|---|
| 0337 91 | 19" Patch Panel - 1 U | ■ | 1 |
|---------|-----------------------|---|---|

Flat High Density 48-Connector Patch Panel - 1 U to be Equipped

| | | | |
|---------|-----------------|---|---|
| 0337 93 | 19" Panel - 1 U | ■ | 1 |
|---------|-----------------|---|---|

Angled 24-Connector Patch Panels - 1 U

Angled Panel to be Equipped with Connectors

It can accept up to 24 cat. 5e to cat. 8 RJ 45 connectors

| | | | |
|---------|-----------------|---|---|
| 0337 92 | 19" Panel - 1 U | ■ | 1 |
|---------|-----------------|---|---|

Angled High Density 48-Connector Patch Panel - 1 U to be Equipped

Angled panel to be equipped with connectors

It can accept up to 48 cat. 5e to cat. 6_A RJ 45 connectors

| | | | |
|---------|-----------------|---|---|
| 0337 94 | 19" Panel - 1 U | ■ | 1 |
|---------|-----------------|---|---|

* MRP - Maximum Retail Price Inclusive of all taxes including GST.
■ Price available on request.

Bold Cat.Nos are products normally available with Legrand (India) Stockists.
Cat.Nos that are not bold - delivery within 4 - 8 weeks from the date of order.
Bold packing quantity is our mandatory packing. Orders to be placed by
Legrand (India) Stockist in multiples of the same.

Legrand Cabling System LCS³ Category 6

| Cat.Nos | Description | MRP* ₹ / Unit | Pack |
|---------|-------------|------------------|------|
|---------|-------------|------------------|------|

Cat. 6 High Density RJ 45 Connectors

| | | | |
|----------------|-----|---|---|
| 0337 63 | UTP | ■ | 1 |
| 0337 64 | FTP | ■ | 1 |
| 0337 65 | STP | ■ | 1 |

Common Accessories for Flat & Angled Panels

Port Blanking Modules

| | | | |
|---------|---|---|----|
| 0337 56 | Divisible 6 port blanking plate for sealing from 1 to 6 ports | ■ | 10 |
|---------|---|---|----|

Cord Management

| | | | |
|---------|--|---|---|
| 0337 59 | For use with new generation Quick-Fix; they provide side cord management | ■ | 1 |
|---------|--|---|---|

Specific Accessories for Flat Panels

| | | | |
|---------|--|---|---|
| 0337 55 | Cassette for flat panels to be equipped | ■ | 1 |
| 0337 95 | High density cassette for flat panels to be equipped | ■ | 1 |
| 0337 57 | Blanking cassette Used to blank the panel | ■ | 1 |



0337 57

Specific Accessories for Angled Panels

Angled Panel Cover

| | | | |
|---------|---|---|--|
| 0337 58 | For optimised management of the air flow inside the cabinet | ■ | |
|---------|---|---|--|



0337 58

Cables for Cat. 6 LANs

Cables with 4 pairs or 2 x 4 twisted pairs
100 ohms. Colour code TIA/EIA
Conform to standards ISO/IEC 11801
Ed. 2.0, EN 50173-1 and TIA/EIA 568 C

LSZH - U/UTP - 4 pairs

| | | | |
|----------|--|---|------------------|
| 0327 54I | Length 305 m. Supplied in cardboard box Weight 16 kg., Violet RAL 4005 | ■ | 305 ¹ |
| 0328 61 | Length 500 m. Supplied on reel. Weight 18 kg. Blue RAL 5015 | ■ | 500 ¹ |

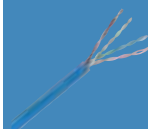

0327 54I

PVC - U/UTP - 4 pairs

| | | | |
|----------|---|---|------------------|
| 0327 55W | Length 305 m Supplied in cardboard box, Weight 13 kg., White RAL 9003, MOQ 50 Box | ■ | 305 ¹ |
| 0327 55 | Length 305 m Supplied in cardboard box Weight 13 kg. Blue RAL 5015 | ■ | 305 ¹ |
| 0327 55O | Length 305 m Supplied in cardboard box, Weight 13 kg., Orange RAL 2008, MOQ 50 Box | ■ | 305 ¹ |
| 0327 55G | Length 305 m Supplied in cardboard box, Weight 13 kg., Green RAL 6018/6024, MOQ 50 Box | ■ | 305 ¹ |

* MRP - Maximum Retail Price Inclusive of all taxes including GST.
■ Price available on request.

Legrand Cabling System LCS³ Category 6

| Cat.Nos | Description | MRP* ₹ / Unit | Pack |
|---------|-------------|------------------|------|
|---------|-------------|------------------|------|

LSZH - U/UTP - 4 pairs

| | | | |
|---------|--|---|------------------|
| 0328 61 | Length 500 m Supplied on reel. Weight 18 kg | ■ | 500 ¹ |
|---------|--|---|------------------|

PVC - U/UTP - 4 pairs

| | | | |
|---------|---|---|------------------|
| 0327 55 | Length 305m Supplied in cardboard box. Weight 13 kg | ■ | 305 ¹ |
|---------|---|---|------------------|

LSZH - F/UTP - 4 pairs

| | | | |
|---------|---|---|------------------|
| 0328 56 | Length 305 m. Supplied on reel. Weight 17 kg | ■ | 305 ¹ |
| 0327 56 | Length 500 m. Supplied on reel. Weight 25 kg | ■ | 500 ¹ |

PVC - F/UTP - 4 pairs

| | | | |
|---------|--|---|------------------|
| 0328 57 | Length 305 m Supplied in cardboard box. Weight 17 kg | ■ | 305 ¹ |
| 0327 58 | Length 500 m Supplied on reel. Weight 25 kg | ■ | 500 ¹ |

LSZH - F/UTP - 2 x 4 pairs

| | | | |
|---------|---|---|------------------|
| 0327 76 | Length 500 m. Supplied on reel. Weight 48 kg | ■ | 500 ¹ |
|---------|---|---|------------------|

LSZH - SF/UTP - 4 pairs

| | | | |
|---------|---|---|------------------|
| 0327 57 | Length 500 m. Supplied on reel. Weight 29 kg | ■ | 500 ¹ |
|---------|---|---|------------------|

PVC - SF/UTP - 4 pairs

| | | | |
|---------|---|---|------------------|
| 0327 59 | Length 500 m. Supplied on reel. Weight 30 kg | ■ | 500 ¹ |
|---------|---|---|------------------|

LSZH - F/FTP - 2 x 4 pairs

| | | | |
|---------|----------------------------|---|--|
| 0327 98 | Length 500 m. Weight 62 kg | ■ | |
|---------|----------------------------|---|--|

PVC - F/FTP - 4 pairs

| | | | |
|---------|------------------------------|---|--|
| 0327 99 | Length 500 m. Weight 25,2 kg | ■ | |
|---------|------------------------------|---|--|

Rj 45 Patch Cords & User Cords Cat. 6

RJ 45 - RJ 45 right

PVC - U/UTP unshielded impedance 100 Ω

| | | | |
|---------|--------------|---|---|
| 0518 18 | Length 0.5 m | ■ | 1 |
| 0517 72 | Length 1 m | ■ | 1 |
| 0517 73 | Length 2 m | ■ | 1 |
| 0517 74 | Length 3 m | ■ | 1 |
| 0517 75 | Length 5 m | ■ | 1 |

Bold Cat.Nos are products normally available with Legrand (India) Stockists.
Cat.Nos that are not bold - delivery within 4 - 8 weeks from the date of order.
Bold packing quantity is our mandatory packing. Orders to be placed by Legrand (India) Stockist in multiples of the same.

Legrand Cabling System LCS³ Category 6

| Cat.Nos | Description | MRP* ₹ / Unit | Pack |
|--|-------------|------------------|------|
| LSZH - U/UTP unscreened impedance 100 Ω | | | |
| 0518 62 | Length 1 m | ■ | 1 |
| 0518 63 | Length 2 m | ■ | 1 |
| 0518 64 | Length 3 m | ■ | 1 |
| 0518 65 | Length 5 m | ■ | 1 |
| 0518 58 | Length 1 m | ■ | 1 |
| 0518 59 | Length 2 m | ■ | 1 |
| 0518 60 | Length 3 m | ■ | 1 |
| 0518 61 | Length 5 m | ■ | 1 |

| Cat.Nos | Description | MRP* ₹ / Unit | Pack |
|---|--------------|------------------|------|
| PVC - F/UTP screened impedance 100 Ω | | | |
| 0518 15 | Length 0.5 m | ■ | 1 |
| 0517 62 | Length 1 m | ■ | 1 |
| 0517 63 | Length 2 m | ■ | 1 |
| 0517 64 | Length 3 m | ■ | 1 |
| 0517 65 | Length 5 m | ■ | 1 |

| Cat.Nos | Description | MRP* ₹ / Unit | Pack |
|--|-------------|------------------|------|
| LSZH - F/UTP screened impedance 100 Ω | | | |
| 0518 54 | Length 1 m | ■ | 1 |
| 0518 55 | Length 2 m | ■ | 1 |
| 0518 56 | Length 3 m | ■ | 1 |
| 0518 57 | Length 5 m | ■ | 1 |
| 0518 50 | Length 1 m | ■ | 1 |
| 0518 51 | Length 2 m | ■ | 1 |
| 0518 52 | Length 3 m | ■ | 1 |
| 0518 53 | Length 5 m | ■ | 1 |

| Cat.Nos | Description | MRP* ₹ / Unit | Pack |
|--|-------------|------------------|------|
| PVC - SF/UTP shielded impedance 100 Ω | | | |
| 0517 52 | Length 1 m | ■ | 5 |
| 0517 53 | Length 2 m | ■ | 5 |
| 0517 54 | Length 3 m | ■ | 5 |
| 0517 55 | Length 5 m | ■ | 5 |

* MRP - Maximum Retail Price Inclusive of all taxes including GST.
■ Price available on request.

Legrand Cabling System LCS³ Category 6

| Cat.Nos | Description | MRP* ₹ / Unit | Pack |
|---------|-------------|------------------|------|
|---------|-------------|------------------|------|

RJ 45 sockets

Sockets with LCS³ quick-fixing crimp connector. Take AWG 22 single-core cables up to AWG 26 and AWG 24 multicore cables. Contacts marked with dual colour code and wiring schemes T 568 A and T 568 B. Conforming to standards ISO/IEC 11801 Ed. 2.0, EN 50173-1 and TIA/EIA 568

Arteor RJ 45 socket cat. 6

UTP - 1 module

| | | | |
|---------|--|---|----|
| 5734 28 | Information Socket - RJ45 - Cat 6 - UTP - 1 Module | ■ | 20 |
| 5736 28 | Information Socket - RJ45 - Cat 6 - UTP - 1 Module | ■ | 20 |
| 5723 54 | White with orange shutter | ■ | 10 |
| 5728 54 | Magnesium with orange shutter | ■ | 10 |
| 5723 55 | White with green shutter | ■ | 10 |
| 5728 55 | Magnesium with green shutter | ■ | 10 |



5736 28

UTP - 2 modules

| | | | |
|---------|--|---|----|
| 5734 74 | Information Socket - RJ45 - Cat 6 - UTP - 2 Module | ■ | 10 |
| 5736 74 | Information Socket - RJ45 - Cat 6 - UTP - 2 Module | ■ | 10 |

UTP - 2 modules - round

| | | | |
|---------|--|---|----|
| 5723 24 | Information Socket - RJ45 - Cat 6 - UTP - 2 Module | ■ | 10 |
| 5728 24 | Information Socket - RJ45 - Cat 6 - UTP - 2 Module | ■ | 10 |



5728 24

UTP with controlled access - 2 modules

Supplied with 2 keys for 5 sockets

| | | | |
|---------|----------------------------|---|---|
| 5723 53 | White with red shutter | ■ | 5 |
| 5728 53 | Magnesium with red shutter | ■ | 5 |

UTP retractable RJ 45 sockets - 4 modules

With integrated retractable cord (0.9 m)
Winds up automatically with a pushbutton

| | | | |
|---------|-----------|---|---|
| 5723 39 | White | ■ | 1 |
| 5728 39 | Magnesium | ■ | 1 |

FTP - 1 module

| | | | |
|---------|-----------|---|----|
| 5723 22 | White | ■ | 10 |
| 5728 22 | Magnesium | ■ | 10 |

Shielded STP - 1 module

| | | | |
|---------|-----------|---|----|
| 5734 34 | White | ■ | 10 |
| 5736 34 | Magnesium | ■ | 10 |

Bold Cat.Nos are products normally available with Legrand (India) Stockists. Cat.Nos that are not bold - delivery within 4 - 8 weeks from the date of order. Bold packing quantity is our mandatory packing. Orders to be placed by Legrand (India) Stockist in multiples of the same.

Legrand Cabling System LCS³ Category 6

| Cat.Nos | Description | MRP* ₹ / Unit | Pack |
|---------|-------------|------------------|------|
|---------|-------------|------------------|------|

Myrius RJ 45 Sockets Cat. 6 UTP - 1 module

| | | | |
|---------|--|---|----|
| 6730 55 | Information Socket - RJ45 - Cat 6 - UTP - 1 Module | ■ | 20 |
| 6731 55 | Information Socket - RJ45 - Cat 6 - UTP - 1 Module | ■ | 20 |

UTP - 2 modules

| | | | |
|---------|--|---|----|
| 6730 56 | Information Socket - RJ45 - Cat 6 - UTP - 2 Module | ■ | 20 |
| 6731 56 | Information Socket - RJ45 - Cat 6 - UTP - 2 Module | ■ | 20 |

Soliroc RJ 45 Sockets Cat. 6 - IK 10

| | | | |
|---------|---|---|----|
| 0778 91 | IP 20 For at-risk areas or areas with no surveillance FTP socket | ■ | 10 |
|---------|---|---|----|

Plexo RJ 45 Sockets Cat. 6 - IP 55 Closed Flap IK 07 Protection against water, dust. For industrial sites

| | | | |
|---------|-----------------------|---|-------|
| 0695 69 | FTP socket Grey/white | ■ | 5/100 |
| 0695 61 | UTP socket Grey/white | ■ | 1/20 |

Plexo 66 RJ 45 Socket Cat. 6 - IP 66 - IK 08 FTP socket

| | | | |
|---------|---|---|---|
| 0904 67 | 9 contacts Weatherproofing ensured (IP 66) with plug inserted Inclined 90° Grey RAL 7016/T029 | ■ | 1 |
|---------|---|---|---|

Keystone RJ 45 Sockets Cat. 6

| | | | |
|---------|---|---|----|
| 0765 88 | Cat 6 UTP socket with fast connection thanks to integrated crimping | ■ | 10 |
|---------|---|---|----|

Surface Mounting Box

1 or 2 ports

| | | | |
|---------|---|---|----|
| 6327 79 | For keystone connectors Provides solution for integration of keystone in surface mounting installations | ■ | 20 |
|---------|---|---|----|

Legrand Cabling System LCS³ Category 5e

Cables for Cat 6 LANs 24 AWG U/UTP - 4 Pairs

| | | | |
|----------|---|---|-----|
| 6327 24 | Length 305 m Supplied in cardboard box Weight 16 kg. Dark grey RAL 7037 | ■ | 305 |
| 6327 24W | Length 305 m Supplied in cardboard box Weight 16 kg. White RAL 9003. MOQ - 50 box | ■ | 305 |
| 6327 24O | Length 305 m Supplied in cardboard box Weight 16 kg. Orange RAL 2008 MOQ 50 Box | ■ | 305 |
| 6327 24G | Length 305 m Supplied in cardboard box Weight 16 kg. Green RAL 6018 / 6024 MOQ 50 Box | ■ | 305 |

* MRP - Maximum Retail Price Inclusive of all taxes including GST.
■ Price available on request.

Legrand Cabling System LCS³ Category 5e

| Cat.Nos | Description | MRP* ₹ / Unit | Pack |
|---------|-------------|------------------|------|
|---------|-------------|------------------|------|

Cat. 5e Patch Panels Equipped with 24 RJ 45 Connectors

Flat panel with empty cassettes to be equipped with connectors

24 RJ 45 connectors - 1 U

| | | | |
|---------|-----|---|---|
| 0337 50 | UTP | ■ | 1 |
| 0337 51 | FTP | ■ | 1 |

Flat 24-Connector Patch Panels - 1 U to be Equipped

Flat panel with empty cassettes to be equipped with connectors

Equipped with 4 automatic extraction cassettes for cat. 5e to cat. 8 RJ 45 connectors

| | | | |
|---------|-----------------|---|---|
| 0337 90 | 19" panel - 1 U | ■ | 1 |
|---------|-----------------|---|---|

Empty flat panel to be equipped with cassettes

It can accept a maximum of 4 automatic extraction cassettes:
- copper
- fibre optic

| | | | |
|---------|-----------------|---|---|
| 0337 91 | 19" panel - 1 U | ■ | 1 |
|---------|-----------------|---|---|

Flat High Density 48-Connector Patch Panel - 1 U to be Equipped

| | | | |
|---------|-----------------|---|---|
| 0337 93 | 19" panel - 1 U | ■ | 1 |
|---------|-----------------|---|---|

Angled 24-Connector Patch Panel - 1 U

Angled panel to be equipped with connectors

It can accept up to 24 cat. 5e to cat. 8 RJ 45 connectors

| | | | |
|---------|-----------------|---|---|
| 0337 92 | 19" panel - 1 U | ■ | 1 |
|---------|-----------------|---|---|

Angled High Density 48-Connector Patch Panel - 1 U to be Equipped

| | | | |
|---------|-----------------|---|---|
| 0337 94 | 19" panel - 1 U | ■ | 1 |
|---------|-----------------|---|---|

Cat. 5e High Density RJ 45 Connectors

| | | | |
|---------|-----|---|---|
| 0337 53 | UTP | ■ | 1 |
| 0337 54 | FTP | ■ | 1 |

Common Accessories for Flat and Angled Panels

Port blanking modules

| | | | |
|---------|---|---|----|
| 0337 56 | Divisible 6 port blanking plate for sealing from 1 to 6 ports | ■ | 10 |
|---------|---|---|----|

Cord management

| | | | |
|---------|---|---|---|
| 0337 59 | For use with new generation Quick-Fix They provide side cord management | ■ | 1 |
|---------|---|---|---|

Bold Cat.Nos are products normally available with Legrand (India) Stockists. Cat.Nos that are not bold - delivery within 4 - 8 weeks from the date of order. Bold packing quantity is our mandatory packing. Orders to be placed by Legrand (India) Stockist in multiples of the same.

Legrand Cabling System LCS³ Category 5e

| Cat.Nos | Description | MRP* ₹ / Unit | Pack |
|---------|-------------|------------------|------|
|---------|-------------|------------------|------|

Specific Accessories for Flat Panels

| | | | |
|---------|--|---|---|
| 0337 55 | Cassette for flat panels to be equipped | ■ | 1 |
| 0337 95 | High density cassette for flat panels to be equipped | ■ | 1 |
| 0337 57 | Blanking cassette Used to blank the panel | ■ | 1 |

Specific Accessories for Angled Panels

Angled panel cover

| | | | |
|---------|---|---|---|
| 0337 58 | For optimised management of the air flow inside the cabinet | ■ | 1 |
|---------|---|---|---|

Cables for Local Networks Cat. 5e

LSZH - F/UTP - 4 pairs

| | | | |
|---------|--|---|------------------|
| 0327 52 | Length 305 m Supplied in cardboard box. Weight 12 kg | ■ | 305 ¹ |
| 0328 50 | Length 500 m Supplied on reel. Weight 21 kg | ■ | 500 ¹ |

PVC - F/UTP - 4 pairs

| | | | |
|---------|---|---|------------------|
| 0327 53 | Length 305 m Supplied by box. Weight 11 kg | ■ | 305 ¹ |
|---------|---|---|------------------|

RJ 45 Patch Cords & User Cords Cat. 5e

RJ 45 - RJ 45 right

PVC - U/UTP unscreened impedance 100 Ω

Grey

| | | | |
|---------|--------------|---|---|
| 0518 17 | Length 0.5 m | ■ | 1 |
| 0516 36 | Length 1 m | ■ | 1 |
| 0516 37 | Length 2 m | ■ | 1 |
| 0516 38 | Length 3 m | ■ | 1 |
| 0516 39 | Length 5 m | ■ | 1 |

F/UTP screened impedance 100 Ω

Grey

| | | | |
|---------|--------------|---|---|
| 0518 14 | Length 0.5 m | ■ | 1 |
| 0516 40 | Length 1 m | ■ | 1 |
| 0516 41 | Length 2 m | ■ | 1 |
| 0516 42 | Length 3 m | ■ | 1 |
| 0516 43 | Length 5 m | ■ | 1 |

Myrius RJ 45 Sockets Cat. 5e

UTP - 1 module

| | | | |
|---------|--|---|----|
| 6730 54 | Information Socket - RJ45 - Cat 5E - UTP - Toolless Systems - 1 Module | ■ | 20 |
| 6731 54 | Information Socket - RJ45 - Cat 5E - 1 Module | ■ | 20 |

Mylic RJ 45 Sockets cat. 5e

UTP - 1 module

| | | | |
|---------|-------|---|----|
| 6755 47 | White | ■ | 20 |
|---------|-------|---|----|

* MRP - Maximum Retail Price Inclusive of all taxes including GST.
■ Price available on request.

Legrand Cabling System LCS³ Category 5e

| Cat.Nos | Description | MRP* ₹ / Unit | Pack |
|---------|-------------|------------------|------|
|---------|-------------|------------------|------|

Arteor RJ 45 Socket Cat. 5e

UTP - 2 modules

| | | | |
|---------|---|---|----|
| 5734 75 | Information Socket - RJ45 - Cat 5E - UTP - 2 Module | ■ | 10 |
| 5736 75 | Magnesium | ■ | 20 |

Plexo RJ 45 Sockets, Cat. 5e - IP 55 Closed Flap IK 07

Protection against water, dust
For industrial sites

| | | | |
|---------|-----------------------|---|------|
| 0695 57 | FTP socket Grey/White | ■ | 1/20 |
| 0695 56 | UTP socket Grey/White | ■ | 1/20 |

Keystone RJ 45 Sockets Cat. 5e

| | | | |
|---------|--|---|----|
| 0765 87 | Cat 5e UTP socket with fast connection thanks to integrated crimping | ■ | 10 |
|---------|--|---|----|

Surface Mounting Box

1 or 2 ports

| | | | |
|---------|--|---|----|
| 6327 79 | For keystone connectors Provides solution for integration of keystone in surface mounting installations | ■ | 20 |
|---------|--|---|----|

Legrand Cabling System LCS³ Doubler Sockets, Adaptors & Accessories

Mobile Doublers

Clip into RJ 45 sockets to double applications

| | | | |
|---------|--|---|----|
| 0327 83 | TV/computer network or telephone double connector | ■ | 10 |
| 0327 47 | Telephone/telephone doubler | ■ | 10 |
| 0327 45 | Computer network/telephone doubler | ■ | 10 |
| 0327 46 | L1/L2 telephone doubler | ■ | 10 |
| 0327 48 | Computer network/computer network double connector | ■ | 10 |

Weatherproof Adaptors

IP 55 - IK 07 - Allow all functions to be adapted
2 Mosaic modules IP 55 operation

Grey/White

| | | | |
|---------|--|---|---|
| 0919 45 | Locking tool (used for changing vandal-proof screws) | ■ | 1 |
|---------|--|---|---|

Bold Cat.Nos are products normally available with Legrand (India) Stockists. Cat.Nos that are not bold - delivery within 4 - 8 weeks from the date of order. Bold packing quantity is our mandatory packing. Orders to be placed by Legrand (India) Stockist in multiples of the same.

Legrand Cabling System LCS³ Doubler Sockets, Adaptors & Accessories

| Cat.Nos | Description | MRP* ₹ / Unit | Pack |
|---------|-------------|------------------|------|
|---------|-------------|------------------|------|

Soliroc adaptor

Used for adapting all functions 2 Mosaic modules
IK 10 - IP 55

| | | | |
|---------|----------------------|---|---|
| 0778 80 | Adaptor with flap | ■ | 1 |
| 0778 81 | Adaptor without flap | ■ | 1 |

Hypra adaptor

| | | | |
|---------|--------------------|---|---|
| 0539 49 | IP 55 adaptor base | ■ | 5 |
|---------|--------------------|---|---|

Cable protection accessories

Plastic material
IP 66/67 guaranteed connection with the pair
Cat.No 0 533 02
IP 55 with no connection for base with blank
Protection for RJ 45 shielded or unshielded cables ensuring a link of category 5
Conform to standards of the IEC 60603-7 series and to standard IEC 61076-3-106 (version 5)
Compatible with products on the market conforming to the standards listed

Plug

| | | | |
|---------|---|---|---|
| 0533 00 | Integrated PE with sealing ring and clamping blades Tool-free assembly Ability to protect cables of category 5e | ■ | 3 |
|---------|---|---|---|

Flush-mounting base

| | | | |
|---------|--|---|---|
| 0533 01 | Locking base Supplied with RJ 45 female/female coupler cat. 5e | ■ | 3 |
|---------|--|---|---|

Kit

| | | | |
|---------|----------------------------|---|---|
| 0533 02 | Flush-mounting base + plug | ■ | 3 |
|---------|----------------------------|---|---|

RJ plugs for round cables

Gold-coated contacts 1.2 µm

RJ 11

| | | | |
|---------|---------------------------|---|----|
| 0517 01 | 4 contacts, width 9.65 mm | ■ | 50 |
|---------|---------------------------|---|----|

RJ 12

| | | | |
|---------|---------------------------|---|----|
| 0517 02 | 6 contacts, width 9.65 mm | ■ | 50 |
|---------|---------------------------|---|----|

RJ 45 cat. 5e

| | | | |
|---------|----------------------------|---|----|
| 0517 03 | 8 contacts, width 11.70 mm | ■ | 50 |
| 0517 04 | 9 contacts, width 11.70 mm | ■ | 50 |

RJ 45 sleeves

| | | | |
|---------|-------|---|----|
| 0517 06 | Black | ■ | 50 |
| 0517 07 | White | ■ | 50 |

* MRP - Maximum Retail Price Inclusive of all taxes including GST.
■ Price available on request.

Legrand Cabling System LCS³ Doubler Sockets, Adaptors & Accessories

| Cat.Nos | Description | MRP* ₹ / Unit | Pack |
|---------|-------------|------------------|------|
|---------|-------------|------------------|------|

Stripping tool

Slits the sheath and releases the conductors by rotation

For twisted pair cables

Does not damage the conductors

Stripper

| | | | |
|---------|--|---|---|
| 0332 62 | For twisted pair and fibre optic cable | ■ | 1 |
|---------|--|---|---|

Crimping tool for RJ 45 plugs

Used for crimping plugs

RJ 4/6/8/9 contacts

Ratchet control of crimping

mechanism Able to cut and strip cables

| | | | |
|---------|--|---|---|
| 0517 09 | Tool with 3 crimping points High resistance steel material | ■ | 1 |
|---------|--|---|---|

Legrand Cabling System LCS³ Data & Telephone Sockets, Patch Panels, Cable

Telephone sockets

RJ 11 and RJ 12 sockets

Equipped with a modular Jack connector with 1/4 turn terminal for fast connection Tap-off possible

| | | | |
|---------|---|---|----|
| 5723 00 | White - RJ 11, 4 contacts 1 module | ■ | 10 |
| 5728 00 | Magnesium - RJ 11, 4 contacts - 1 module | ■ | 10 |
| 5723 13 | White - RJ 11, 4 contacts - 2 modules | ■ | 10 |
| 5728 13 | Magnesium - RJ 11, 4 contacts - 2 modules | ■ | 10 |

Audio/video system

Single master - 2 modules

With IDC connection

Conform to British Telecom

| | | | |
|---------|-----------|---|----|
| 5723 10 | White | ■ | 10 |
| 5728 10 | Magnesium | ■ | 10 |

Single secondary - 1 module

With IDC connection

Conform to British Telecom

| | | | |
|---------|-----------|---|---|
| 5723 01 | White | ■ | 5 |
| 5728 01 | Magnesium | ■ | 5 |

Bold Cat.Nos are products normally available with Legrand (India) Stockists. Cat.Nos that are not bold - delivery within 4 - 8 weeks from the date of order. Bold packing quantity is our mandatory packing. Orders to be placed by Legrand (India) Stockist in multiples of the same.



0539 49



0533 00



0533 01

Audio/Video System

| Cat.Nos | Description | MRP* ₹ / Unit | Pack |
|---------|-------------|------------------|------|
|---------|-------------|------------------|------|

Patch Panel Telephone 50 ports 110 Connect

| | | | |
|---------|-----------------|---|---|
| 0335 79 | 19" panel - 1 U | ■ | 1 |
|---------|-----------------|---|---|

Female HD15 Sockets

Used to transmit analogue video streams (VGA, XGA, UXGA depending on graphic card) between a source (computer) and a compatible receiver (video projector, TV, etc)

Arteor - Preterminated sockets - 1 module

Equipped with cord, length 15 cm

| | | | |
|---------|-----------|---|---|
| 5720 97 | White | ■ | 1 |
| 5725 97 | Magnesium | ■ | 1 |

Arteor - Screw-type female HD15 sockets - 2 modules

| | | | |
|---------|-------|---|---|
| 5722 82 | White | ■ | 1 |
|---------|-------|---|---|

Arteor - Screw-type female HD15 sockets 2 modules + 3.5 mm Jack

| | | | |
|---------|-----------|---|---|
| 5722 88 | White | ■ | 1 |
| 5727 88 | Magnesium | ■ | 1 |

HDMI Type A Sockets

Used to transmit high-definition digital audio/video streams between a source (computer, HD-DVD drive, etc) and a compatible receiver (TV, video projector, etc)

Arteor - Preterminated sockets HDMI 1.4 - 1 module

Equipped with cord, length 15 cm

| | | | |
|---------|-----------|---|---|
| 5720 96 | White | ■ | 1 |
| 5725 96 | Magnesium | ■ | 1 |

Jack Sockets 3.5 mm

3.5 mm Jack connectors can be used to create audio/video links

Arteor - Preterminated sockets - 1 module

Equipped with cord, length 15 cm

| | | | |
|---------|-----------|---|---|
| 5720 91 | White | ■ | 1 |
| 5725 91 | Magnesium | ■ | 1 |

Arteor - 4 screw-type female 3.5 mm Jack socket - 1 module

| | | | |
|---------|-----------|---|---|
| 5722 74 | White | ■ | 1 |
| 5727 74 | Magnesium | ■ | 1 |

* MRP - Maximum Retail Price Inclusive of all taxes including GST.
■ Price available on request.



0335 79



5720 97



5720 96

Audio/Video System

| Cat.Nos | Description | MRP* ₹ / Unit | Pack |
|---------|-------------|------------------|------|
|---------|-------------|------------------|------|

Arteor - Solder-type female 3.5 mm Jack socket - 1 module

| | | | |
|---------|-------|---|---|
| 5722 78 | White | ■ | 1 |
|---------|-------|---|---|

Display Port Sockets

Used to transmit high-definition digital audio/video streams between a source (laptop, computer, etc) and a compatible receiver (video projector, TV, etc)

Arteor - Preterminated socket - 1 module

Equipped with cord, length 15 cm

| | | | |
|---------|-----------|---|---|
| 5720 90 | White | ■ | 1 |
| 5725 90 | Magnesium | ■ | 1 |

Arteor - Female 2 RCA Socket

Preterminated

Equipped with a 15 cm cord

| | | | |
|---------|-----------|---|---|
| 5720 92 | White | ■ | 1 |
| 5725 92 | Magnesium | ■ | 1 |

Connection via screw terminals

| | | | |
|---------|-----------|---|---|
| 5722 72 | White | ■ | 1 |
| 5727 72 | Magnesium | ■ | 1 |



5722 72

Arteor - Female 3 RCA Socket

Connection via screw terminals

| | | | |
|---------|-----------|---|---|
| 5722 73 | White | ■ | 1 |
| 5727 73 | Magnesium | ■ | 1 |



5727 73

Other Audio & Video Sockets

Female BNC 75 socket - 1 module

| | | | |
|---------|-----------|---|---|
| 5722 76 | White | ■ | 1 |
| 5727 76 | Magnesium | ■ | 1 |



5722 76

Arteor - Audio Sockets

XLR 3-pin - 2 modules

| | | | |
|---------|--|---|---|
| 5722 83 | White - Fast screw connection female | ■ | 1 |
| 5727 83 | Magnesium - Fast screw connection female | ■ | 1 |
| 5722 77 | White - Fast screw connection male | ■ | 1 |



5722 83

Loudspeakers sockets

Terminal 4 mm²

| | | | |
|---------|-----------------------|---|----|
| 5722 80 | White - 2 modules | ■ | 10 |
| 5727 80 | Magnesium - 2 modules | ■ | 10 |
| 5722 70 | White - 1 module | ■ | 10 |
| 5727 70 | Magnesium - 1 module | ■ | 10 |



5727 70

Bold Cat.Nos are products normally available with Legrand (India) Stockists. Cat.Nos that are not bold - delivery within 4 - 8 weeks from the date of order. Bold packing quantity is our mandatory packing. Orders to be placed by Legrand (India) Stockist in multiples of the same.

Audio/Video System

Audio/Video Patch Panels, Cords & Cables

| Cat.Nos | Description | MRP* ₹ / Unit | Pack |
|---------|-------------|------------------|------|
|---------|-------------|------------------|------|

100 V Line Volume Attenuators - 2 modules

Used to adjust power and volume of a 100 V loudspeaker line

| | | | |
|---------|--------------------------|---|---|
| 5722 84 | White - 100 V - 25 W | ■ | 1 |
| 5727 84 | Magnesium - 100 V - 25 W | ■ | 1 |

19" Patch Panels

| | | | |
|---------|--------------------------------|---|---|
| 0335 98 | HD15 19" panel - 12 connectors | ■ | 1 |
|---------|--------------------------------|---|---|

Cords

For connecting a socket to a terminal

HDMI 1.4 cord

| | | | |
|----------|-------------|---|---|
| 0517 27* | Length 5 m | ■ | 1 |
| 0517 20* | Length 10 m | ■ | 1 |

Legrand Cabling System LCS³

Fibre Optic

Equipped 19" Optic Drawers

Sliding

| | | | |
|---------|---|---|---|
| 0321 61 | 12 SC duplex multi-mode connectors for 24 fibres | ■ | 1 |
| 0321 62 | 24 LC duplex multi-mode connectors for 48 fibres | ■ | 1 |
| 0321 63 | 24 ST multi-mode connectors for 48 fibres | ■ | 1 |
| 0321 64 | 12 SC duplex single-mode connectors for 24 fibres | ■ | 1 |
| 0321 65 | 24 LC duplex single-mode connectors for 48 fibres | ■ | 1 |
| 0321 66 | 12 SC APC duplex single-mode connectors for 24 fibres | ■ | 1 |
| 0321 67 | 24 LC APC duplex single-mode connectors for 48 fibres | ■ | 1 |

Rotating

| | | | |
|---------|---|---|---|
| 0321 71 | 36 LC duplex multi-mode connectors for 72 fibres | ■ | 1 |
| 0321 72 | 18 SC duplex multi-mode connectors for 36 fibres | ■ | 1 |
| 0321 73 | 36 LC duplex single-mode connectors for 72 fibres | ■ | 1 |
| 0321 74 | 18 SC duplex single-mode connectors for 36 fibres | ■ | 1 |

19" Modular Optic Drawers

Sliding, equipped

| | | | |
|---------|---|---|---|
| 0321 02 | 12 SC duplex multi-mode connectors for 24 fibres | ■ | 1 |
| 0321 04 | 24 LC duplex multi-mode connectors for 48 fibres | ■ | 1 |
| 0321 06 | 12 SC duplex single-mode connectors for 24 fibres | ■ | 1 |

* MRP - Maximum Retail Price Inclusive of all taxes including GST.
■ Price available on request.

Legrand Cabling System LCS³

Fibre Optic

| Cat.Nos | Description | MRP* ₹ / Unit | Pack |
|---------|-------------|------------------|------|
|---------|-------------|------------------|------|

Sliding, to be equipped with fibre optic blocks

It can accept all fibre optic blocks; 4 blocks maximum

| | | | |
|---------|--------------|---|---|
| 0321 00 | Empty drawer | ■ | 1 |
|---------|--------------|---|---|

Fibre Optic Blocks

Singlemode fibre optic blocks (9/125 µm)

| | | | |
|---------|--|---|---|
| 0321 17 | ST block for 6 single-mode fibre optics | ■ | 1 |
| 0321 10 | SC duplex block for 6 single-mode fibre optics | ■ | 1 |
| 0321 11 | SC duplex high density block for 12 single-mode fibre optics | ■ | 1 |
| 0321 12 | SC APC duplex block for 6 single-mode fibre optics | ■ | 1 |
| 0321 13 | LC duplex block for 6 single-mode fibre optics | ■ | 1 |
| 0321 14 | LC duplex block for 12 single-mode fibre optics | ■ | 1 |
| 0321 15 | LC duplex high density block for 24 single-mode fibre optics | ■ | 1 |
| 0321 16 | LC APC duplex block for 12 single-mode fibre optics | ■ | 1 |
| 0321 33 | Single-mode 4 MTP ¹ feedthrough adapter | ■ | 1 |

Multimode fibre optic blocks (62.5 and 50/125 µm)

| | | | |
|---------|--|---|---|
| 0321 27 | ST block for 6 multimode fibre optics | ■ | 1 |
| 0321 20 | SC duplex block for 6 multimode fibre optics | ■ | 1 |
| 0321 21 | SC duplex high density block for 12 multimode fibre optics | ■ | 1 |
| 0321 23 | LC duplex block for 6 multimode fibre optics | ■ | 1 |
| 0321 24 | LC duplex block for 12 multimode fibre optics | ■ | 1 |
| 0321 25 | LC duplex high density block for 24 multimode fibre optics | ■ | 1 |
| 0321 34 | Multimode 4 MTP ¹ feedthrough adapter | ■ | 1 |

Bold Cat.Nos are products normally available with Legrand (India) Stockists. Cat.Nos that are not bold - delivery within 4 - 8 weeks from the date of order. Bold packing quantity is our mandatory packing. Orders to be placed by Legrand (India) Stockist in multiples of the same.

Legrand Cabling System LCS³ Fibre Optic

| Cat.Nos | Description | MRP* ₹ / Unit | Pack |
|---------|-------------|------------------|------|
|---------|-------------|------------------|------|

Copper Block for Fibre Optic Drawer

| | | | |
|---------|---|---|---|
| 0321 32 | "It clips directly to the optic drawer to be equipped, Cat.No 0321 00 It gives the possibility of mixing fibre optic and copper" | ■ | 1 |
|---------|---|---|---|

Accessories for Optic Drawer to be Equipped

Accessory for receipt of a fan-out

| | | | |
|---------|---|---|---|
| 0321 28 | It's clipped at the back of the drawer It enables the entry of preterminated Cat.Nos | ■ | 1 |
|---------|---|---|---|

Blank

| | | | |
|---------|-------------|---|---|
| 0321 29 | Blank block | ■ | 1 |
|---------|-------------|---|---|

Pigtail cassette

| | | | |
|---------|--------------------------|---|---|
| 0321 30 | Capacity 24 fibre optics | ■ | 1 |
|---------|--------------------------|---|---|

Coiling kit

| | | | |
|---------|-------------|---|---|
| 0321 31 | 1 accessory | ■ | 1 |
|---------|-------------|---|---|

Optic Drawer Cassettes

Fibre optic splice cassette

| | | | |
|---------|--|---|---|
| 0321 41 | It can accept all modular fibre optic blocks | ■ | 1 |
|---------|--|---|---|

Copper cassette to be equipped

| | | | |
|---------|--|---|---|
| 0337 55 | It can accept 6 cat. 5e, cat. 6 and cat. 6 _a connectors | ■ | 1 |
|---------|--|---|---|

MTP¹ preterminated cassette (MPO compatible)

Front and rear extraction

High performance cassette, low insertion loss

<0.35 dB

| | | | |
|---------|---|---|---|
| 0321 42 | Multimode OM4 cassette (50/125 µm) 24 filaments LC OM4 Type A/C | ■ | 1 |
| 0321 43 | Multimode OM4 cassette (50/125 µm) 12 SC OM4 Type A/C | ■ | 1 |
| 0321 44 | Single-mode OS2 cassette (9/125 µm) type OS2 24 LC OS2 Type A/C | ■ | 1 |
| 0321 45 | Single-mode OS2 cassette (9/125 µm) 12 SC OS2 Type A/C | ■ | 1 |

* MRP - Maximum Retail Price Inclusive of all taxes including GST.
■ Price available on request.

Legrand Cabling System LCS³ Fibre Optic

| Cat.Nos | Description | MRP* ₹ / Unit | Pack |
|---------|-------------|------------------|------|
|---------|-------------|------------------|------|

Blanking cassette

| | | | |
|---------|-------------------------|---|---|
| 0337 57 | Used to blank the panel | ■ | 1 |
|---------|-------------------------|---|---|

Adapters

| | | | |
|---------|--|---|---|
| 0321 33 | Single-mode 4 MTP ¹ adapter (installation in cassette 0 321 41) | ■ | 1 |
| 0321 34 | Multi-mode 4 MTP ¹ adapter (installation in cassette 0 321 41) | ■ | 1 |

Accessories for 19" Panel to be Equipped with Cassettes

| | | | |
|---------|---|---|---|
| 0321 46 | Rear cable management accessory For installation on panels Cat.No 0 321 40 | ■ | 1 |
|---------|---|---|---|

Pigtails

50/125 µm - OM3 (PC)

Connectors

| | | | |
|---------|-------------|---|----|
| 0322 20 | SC 1 m LSZH | ■ | 10 |
| 0322 21 | LC 1 m LSZH | ■ | 10 |
| 0322 22 | ST 1 m LSZH | ■ | 10 |
| 0322 23 | SC 2 m LSZH | ■ | 10 |
| 0322 24 | LC 2 m LSZH | ■ | 10 |

50/125 µm - OM4 (PC)

Connectors

| | | | |
|---------|-------------|---|----|
| 0322 30 | SC 1 m LSZH | ■ | 10 |
| 0322 31 | LC 1 m LSZH | ■ | 10 |
| 0322 32 | ST 1 m LSZH | ■ | 10 |
| 0322 33 | SC 2 m LSZH | ■ | 10 |
| 0322 34 | LC 2 m LSZH | ■ | 10 |

Bold Cat.Nos are products normally available with Legrand (India) Stockists. Cat.Nos that are not bold - delivery within 4 - 8 weeks from the date of order. Bold packing quantity is our mandatory packing. Orders to be placed by Legrand (India) Stockist in multiples of the same.



0321 41

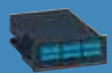

0321 43



0321 46



0322 20



0322 31

Legrand Cabling System LCS³

Fibre Optic

| Cat.Nos | Description | MRP* ₹ / Unit | Pack |
|---|---------------------|------------------|------|
| 9/125 µm - OS2 (APC or UPC) - OS1 compatible | | | |
| Connectors | | | |
| 0322 40 | SC-APC OS2 1 m LSZH | ■ | 10 |
| 0322 41 | SC-UPC OS2 1 m LSZH | ■ | 10 |
| 0322 42 | LC-APC OS2 1 m LSZH | ■ | 10 |
| 0322 43 | LC-UPC OS2 1 m LSZH | ■ | 10 |
| 0322 44 | ST-UPC OS2 1 m LSZH | ■ | 10 |
| 0322 45 | SC-APC OS2 2 m LSZH | ■ | 10 |
| 0322 46 | SC-UPC OS2 2 m LSZH | ■ | 10 |
| 0322 47 | LC-UPC OS2 2 m LSZH | ■ | 10 |
| 0322 48 | LC-APC OS2 2 m LSZH | ■ | 10 |

Set of 12 LC Pigtaills

| | | | |
|---------|-------------------------|---|---|
| 0326 24 | OS2 12 pigtaills LC-UPC | ■ | 1 |
| 0326 26 | OM3 12 pigtaills LC-PC | ■ | 1 |
| 0326 71 | OM4 12 pigtaills LC-PC | ■ | 1 |

Pigtail Sleeves

| | | | |
|---------|---------------------------|---|---|
| 0327 44 | 40 mm - bag of 50 sheaths | ■ | 1 |
|---------|---------------------------|---|---|

Fan-Out Units

| | | | |
|---------|-----------------------------|---|---|
| 0330 48 | 6 fibre optic fan-out unit | ■ | 1 |
| 0330 49 | 12 fibre optic fan-out unit | ■ | 1 |

Precision Cleaver for the Update of the Case Kit Cat.No 0326 90

| | | | |
|---------|---|---|---|
| 0322 80 | It's used in conjunction with the kit of the case Cat.No 0 326 90, to cut the fibre optic with precision, and fit the quick-connect connectors, Cat.No 0 322 71 to 0 322 75 | ■ | 1 |
|---------|---|---|---|

High Density MTP1 Cassette (MPO compatible)

Fibre optic splice cassette

| | | | |
|---------|--|---|---|
| 0321 41 | It can accept all modular fibre optic blocks | ■ | 1 |
|---------|--|---|---|

* MRP - Maximum Retail Price Inclusive of all taxes including GST.

■ Price available on request.

1: MTP is a registered trademark of US Conec Ltd

Legrand Cabling System LCS³

Fibre Optic

| Cat.Nos | Description | MRP* ₹ / Unit | Pack |
|---------|-------------|------------------|------|
|---------|-------------|------------------|------|

Copper cassette to be equipped

| | | | |
|---------|--|---|---|
| 0337 55 | It can accept 6 cat. 5e, cat. 6 and cat. 6A connectors | ■ | 1 |
|---------|--|---|---|

Multimode OM4 cassettes (50/125 µm)

| | | | |
|---------|---|---|---|
| 0321 42 | MTP ¹ cassette (MPO compatible) 24 LC OM4 Type A/C | ■ | 1 |
| 0321 43 | MTP ¹ cassette (MPO compatible) 12 SC OM4 Type A/C | ■ | 1 |

Single-mode OS2 cassettes (9/125 µm)

OS2 type

| | | | |
|---------|---|---|---|
| 0321 44 | MTP ¹ cassette (MPO compatible) 24 LC OS2 Type A/C | ■ | 1 |
| 0321 45 | MTP ¹ cassette (MPO compatible) 12 SC OS2 Type A/C | ■ | 1 |

Blanking cassette

| | | | |
|---------|-------------------------|---|---|
| 0337 57 | Used to blank the panel | ■ | 1 |
|---------|-------------------------|---|---|

MTP¹ Adapters

It's installed in splice cassettes, Cat.No 0 321 41

It enables MTP¹/MTP¹ feedthrough

| | | | |
|---------|--|---|---|
| 0321 33 | Single-mode 4 MTP ¹ adapter | ■ | 1 |
| 0321 34 | Multimode 4 MTP ¹ adapter | ■ | 1 |

Accessories for 19" Panel to be Equipped with Cassette

| | | | |
|---------|--|---|---|
| 0321 46 | Rear cable management accessory For installation on panels Cat.No 0 321 40 | ■ | 1 |
|---------|--|---|---|

Legrand Cabling System LCS³

Cables

Micro cables OM3 MTP1

| | | | |
|---------|--|---|---|
| 0324 41 | 12 fibre optics - MTP ¹ -MTP ¹ Length 10 (m) | ■ | 1 |
| 0324 42 | 12 fibre optics - MTP ¹ -MTP ¹ Length 20 (m) | ■ | 1 |
| 0324 43 | 12 fibre optics - MTP ¹ -MTP ¹ Length 30 (m) | ■ | 1 |
| 0324 44 | 12 fibre optics - MTP ¹ -MTP ¹ Length 40 (m) | ■ | 1 |
| 0324 45 | 12 fibre optics - MTP ¹ -MTP ¹ Length 50 (m) | ■ | 1 |



0324 41

Bold Cat.Nos are products normally available with Legrand (India) Stockists. Cat.Nos that are not bold - delivery within 4 - 8 weeks from the date of order. Bold packing quantity is our mandatory packing. Orders to be placed by Legrand (India) Stockist in multiples of the same.

Legrand Cabling System LCS³

Cables

| Cat.Nos | Description | MRP* ₹ / Unit | Pack |
|------------------------------|---|------------------|------|
| Micro Cables OS2 MTP1 | | | |
| 0324 51 | 12 fibre optics - MTP ¹ -MTP ¹ Length 10 (m) | ■ | 1 |
| 0324 52 | 12 fibre optics - MTP ¹ -MTP ¹ Length 20 (m) | ■ | 1 |
| 0324 53 | 12 fibre optics - MTP ¹ -MTP ¹ Length 30 (m) | ■ | 1 |
| 0324 54 | 12 fibre optics - MTP ¹ -MTP ¹ Length 40 (m) | ■ | 1 |
| 0324 55 | 12 fibre optics - MTP ¹ -MTP ¹ Length 50 (m) | ■ | 1 |

OM 4 Multimode Fibre Optic Cables (50/125 µm)

"Bend insensitive"

For multimode installations 50/125 µm, type OM 4

Aqua sheaths

Suitable for 10 Giga Ethernet networks

Loose Tube

| | | | |
|---------|--|---|------|
| 0325 43 | Indoor/outdoor (glass strands) 4 fibres - 2000 m | ■ | 2000 |
| 0325 44 | Indoor/outdoor (glass strands) 8 fibres - 2000 m | ■ | 2000 |
| 0325 45 | Indoor/outdoor (glass strands) 12 fibres - 2000 m | ■ | 2000 |
| 0325 46 | Outdoor, corrugated steel tape 4 fibres - 2000 m | ■ | 2000 |
| 0325 47 | Outdoor, corrugated steel tape 8 fibres - 2000 m | ■ | 2000 |
| 0325 48 | Outdoor, corrugated steel tape 12 fibres - 2000 m | ■ | 2000 |

Tight Structure 900 µm

| | | | |
|---------|--|---|------|
| 0326 65 | Indoor/outdoor (glass strands) 6 fibres - 500 m | ■ | 2000 |
| 0326 66 | Indoor/outdoor (glass strands) 6 fibres - 1000 m | ■ | 2000 |
| 0326 67 | Indoor/outdoor (glass strands) 12 fibres - 1000 m | ■ | 2000 |
| 0326 68 | Indoor/outdoor (glass strands) 24 fibres - 1000 m | ■ | 2000 |

OS 2 Single-Mode Fibre Optic Cables (9/125 µm) - (OS1 Compatible)

For single-mode installations 9/125 µm,

type OS 2

Yellow or black sheaths for outdoor,
rodent guard...

Loose tube

| | | | |
|---------|--|---|------|
| 0325 02 | Indoor/outdoor (glass strands) 4 fibres | ■ | 2000 |
| 0325 03 | Indoor/outdoor (glass strands) 8 fibres | ■ | 2000 |
| 0325 23 | Outdoor, corrugated steel tape 4 fibres | ■ | 2000 |

* MRP - Maximum Retail Price Inclusive of all taxes including GST.

■ Price available on request.

Legrand Cabling System LCS³

Patch Cords

| Cat.Nos | Description | MRP* ₹ / Unit | Pack |
|---------|-------------|------------------|------|
|---------|-------------|------------------|------|

Loose tube

| | | | |
|---------|---|---|------|
| 0325 24 | Outdoor, corrugated steel tape 8 fibres | ■ | 2000 |
| 0325 25 | Outdoor, corrugated steel tape 24 fibres | ■ | 2000 |
| 0325 12 | Indoor/outdoor (glass strands) 6 fibres | ■ | 2000 |
| 0325 14 | Indoor/outdoor (glass strands) 12 fibres | ■ | 2000 |
| 0325 51 | Indoor/outdoor (glass strands) 24 fibres | ■ | 2000 |

Tight structure 900 µm

| | | | |
|---------|---|---|------|
| 0325 50 | Indoor/outdoor (glass strands) 12 fibres | ■ | 2000 |
|---------|---|---|------|

OM 3 Multimode Fibre Optic Cables (50/125 µm)

"Bend insensitive"

For multimode installations 50/125 µm, type OM 3

Aqua sheaths

Suitable for 10 Giga Ethernet networks

Loose tube

| | | | |
|---------|---|---|------|
| 0325 53 | Indoor/outdoor (glass strands) 24 fibres | ■ | 2000 |
| 0325 37 | Indoor/outdoor (glass strands) 4 fibres | ■ | 2000 |
| 0325 38 | Indoor/outdoor (glass strands) 8 fibres | ■ | 2000 |
| 0325 39 | Indoor/outdoor (glass strands) 12 fibres | ■ | 2000 |
| 0325 40 | Outdoor, corrugated steel tape 8 fibres | ■ | 2000 |
| 0325 41 | Outdoor, corrugated steel tape 12 fibres | ■ | 2000 |
| 0325 42 | Outdoor, corrugated steel tape 24 fibres | ■ | 2000 |

Tight structure 900 µm

| | | | |
|---------|---|---|------|
| 0325 11 | Indoor/outdoor (glass strands) 12 fibres | ■ | 2000 |
| 0325 52 | Indoor/outdoor (glass strands) 24 fibres | ■ | 2000 |

Legrand cabling system LCS³

Patch Cords

OS 1/OS 2 (UPC) Single-Mode Optical Cords

SC/SC duplex cords

| | | | |
|---------|-------------|---|---|
| 0326 00 | Length: 1 m | ■ | 3 |
| 0326 01 | Length: 2 m | ■ | 3 |
| 0326 02 | Length: 3 m | ■ | 3 |

Bold Cat.Nos are products normally available with Legrand (India) Stockists.
Cat.Nos that are not bold - delivery within 4 - 8 weeks from the date of order.
Bold packing quantity is our mandatory packing. Orders to be placed by
Legrand (India) Stockist in multiples of the same.



0326 66

Legrand Cabling System LCS³ Patch Cords

| Cat.Nos | Description | MRP* ₹ / Unit | Pack |
|---------|-------------|------------------|------|
|---------|-------------|------------------|------|

SC/LC duplex cords

| | | | |
|---------|-------------|---|---|
| 0326 03 | Length: 1 m | ■ | 3 |
| 0326 04 | Length: 2 m | ■ | 3 |
| 0326 05 | Length: 3 m | ■ | 3 |

LC/LC duplex cords

| | | | |
|---------|---------------|---|---|
| 0326 28 | Length: 0.5 m | ■ | 3 |
| 0326 06 | Length: 1 m | ■ | 3 |
| 0326 07 | Length: 2 m | ■ | 3 |
| 0326 08 | Length: 3 m | ■ | 3 |
| 0326 29 | Length: 5 m | ■ | 3 |

LC/LC Uniboot duplex cords

Reversible polarity

| | | | |
|---------|--------------|---|---|
| 0326 86 | Length: 1 m | ■ | 3 |
| 0326 87 | Length: 2 m | ■ | 3 |
| 0326 88 | Length: 3 m | ■ | 3 |
| 0326 89 | Length: 5 m | ■ | 3 |
| 0326 92 | Length: 10 m | ■ | 3 |

OM 4 Multimode Fibre Optic Cords (50/125 µm)

SC/SC duplex cords

| | | | |
|---------|-------------|---|---|
| 0326 30 | Length: 1 m | ■ | 3 |
| 0326 31 | Length: 2 m | ■ | 3 |
| 0326 32 | Length: 3 m | ■ | 3 |

LC/LC duplex cords

| | | | |
|---------|---------------|---|---|
| 0326 33 | Length: 0.5 m | ■ | 3 |
| 0326 34 | Length: 1 m | ■ | 3 |
| 0326 35 | Length: 2 m | ■ | 3 |
| 0326 36 | Length: 3 m | ■ | 3 |
| 0326 37 | Length: 5 m | ■ | 3 |

LC/LC Uniboot duplex cords

Reversible polarity

| | | | |
|---------|--------------|---|---|
| 0326 95 | Length: 1 m | ■ | 3 |
| 0326 96 | Length: 2 m | ■ | 3 |
| 0326 97 | Length: 3 m | ■ | 3 |
| 0326 98 | Length: 5 m | ■ | 3 |
| 0326 99 | Length: 10 m | ■ | 3 |

* MRP - Maximum Retail Price Inclusive of all taxes including GST.
■ Price available on request.



0326 07



0326 08



0326 13

Legrand Cabling System LCS³ Patch Cords

| Cat.Nos | Description | MRP* ₹ / Unit | Pack |
|---------|-------------|------------------|------|
|---------|-------------|------------------|------|

Legrand Cabling System LCS³ Fibre Optic Preterminated Solution

OM 3 Multimode Fibre Optic Cords (50/125 µm)

SC/SC duplex cords

| | | | |
|---------|-------------|---|---|
| 0326 09 | Length: 1 m | ■ | 3 |
| 0326 10 | Length: 2 m | ■ | 3 |
| 0326 11 | Length: 3 m | ■ | 3 |

SC/LC duplex cords

| | | | |
|---------|-------------|---|---|
| 0326 12 | Length: 1 m | ■ | 3 |
| 0326 13 | Length: 2 m | ■ | 3 |
| 0326 14 | Length: 3 m | ■ | 3 |

LC/LC duplex cords

| | | | |
|---------|-------------|---|---|
| 0326 15 | Length: 1 m | ■ | 3 |
| 0326 16 | Length: 2 m | ■ | 3 |
| 0326 17 | Length: 3 m | ■ | 3 |

Fibre Optic Feed through Sockets

2 x ST fibre optic feedthrough socket

Bayonet mount (STI compatible)

| | | | |
|---------|-------|---|---|
| 0786 16 | White | ■ | 1 |
|---------|-------|---|---|

2 x SC fibre optic feedthrough socket

"Push-pull" connection

| | | | |
|---------|-------|---|---|
| 0786 17 | White | ■ | 1 |
|---------|-------|---|---|

2 x LC fibre optic feedthrough socket

"Push-pull" connection

| | | | |
|---------|-------|---|---|
| 0786 18 | White | ■ | 1 |
|---------|-------|---|---|

Bold Cat.Nos are products normally available with Legrand (India) Stockists. Cat.Nos that are not bold - delivery within 4 - 8 weeks from the date of order. Bold packing quantity is our mandatory packing. Orders to be placed by Legrand (India) Stockist in multiples of the same.

KIT VIDEO DOOR PHONE

Standalone Video Door Phone Kit for Secure Entry Control



Standalone Video Door Phone Kit enhances residential security with a complete entry monitoring solution. Combining an indoor monitor and outdoor camera unit, it enables clear visual communication and controlled access for modern homes.

Features

- Outdoor video unit with wide-angle camera and night vision for visitor identification
- 7-inch indoor monitor with push-button or touch interface for call management
- Two-way audio and video communication with remote door unlock functionality
- Flexible configurations supporting single or dual indoor monitors for multiple entrances

Benefits

- Improves home security by allowing visual verification of visitors before entry
- Enhances convenience with real-time communication and door access control
- Supports flexible home setups with scalable indoor monitor configurations
- Provides reliable everyday protection through a simple and complete entry system

Scan to know more about the product.





KIT VIDEO

with memory

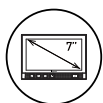

7" LCD screen with the resolution 1024*600



Built-in memory for 120 images

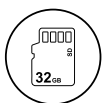

External SD card support



2MP Camera

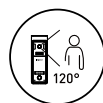

120° camera angle



Colour night vision



Snap/video recording

Manage One Entrance

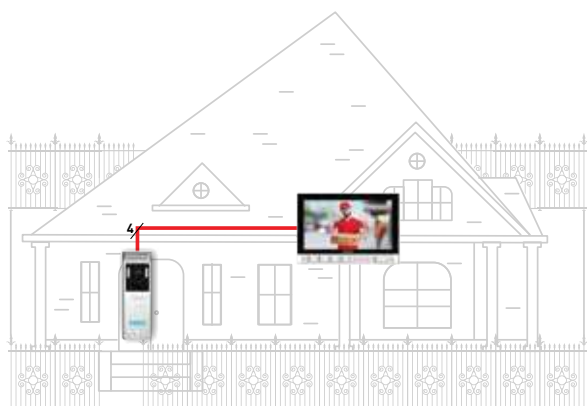

INSTALL 1 VIDEO KIT

Indoor Monitor 7" Push Buttons

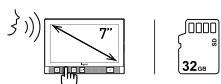

Built-in/Expandable memory

Manage Two Entrance

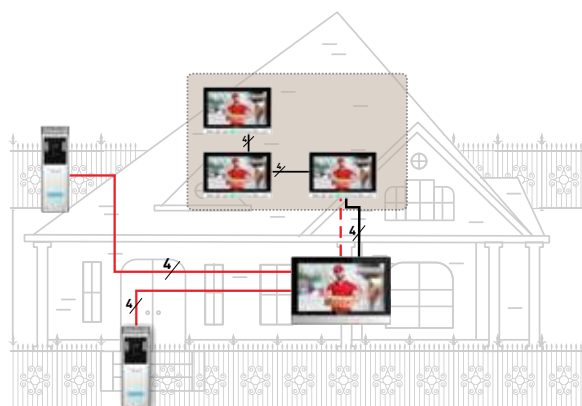

INSTALL 1 VIDEO KIT+ 1 ADDITIONAL ENTRANCE PANEL +3 ADDITIONAL INDOOR MONITORS

----- Add and mix up to 4 Indoor Monitors.

Indoor Monitor 7" Touch Buttons



STANDALONE

Lighting Management Sensors

Standalone Sensors for Intelligent Lighting Control



Standalone Lighting Management Sensors provide a simple and energy-efficient solution for automated lighting control. Designed for offices, homes, and public spaces, they help reduce energy waste by automatically managing lighting based on occupancy and ambient conditions.

Features

- Occupancy, daylight, and combined sensors for automated lighting and HVAC control
- Compact and discreet designs that integrate seamlessly into modern interiors
- Reliable motion and light detection for accurate automation
- Adjustable sensitivity and delay settings for customized operation

Benefits

- Reduces energy consumption by automatically switching lights based on occupancy and daylight levels
- Simplifies installation with standalone plug-and-play functionality
- Supports sustainable buildings by improving energy efficiency
- Ensures dependable long-term operation with low maintenance requirements

Scan to know more about the product.



Movement Detectors

| Cat.Nos | Description | MRP* ₹ / Unit | Pack |
|---------|-------------|------------------|------|
|---------|-------------|------------------|------|

Movement Detectors for Lighting Control

IP 20-IP 55 movement detector with 180- 360° detection angle. For 2000 Watt incandescent, 500 VA LED, 1000 VA fluorescent

| | | | |
|---------|--|-------|------|
| 0487 36 | Motion sensor PIR 360° Surface Mounting - 8m detection range - IP20 rated - Adjustable sensitivity and time delay | 2746 | 1/20 |
| 0487 37 | Motion sensor PIR 360° Recessed ceiling Mounting - 8m detection range - IP20 rated - Adjustable sensitivity and time delay | 2466 | 1/36 |
| 0487 38 | Microwave Motion sensor 360° - 8m range - IP20 - Recessed ceiling mounting - White | 4114 | 1/36 |
| 0488 99 | PIR 360° motion sensor Ø8m - IP20 - false ceiling mounting | 6420 | 1/10 |
| 0488 06 | Dual Tech - infra-red (PIR) and ultrasound (US) ceiling detector switch sensor 360° | 13766 | 1/10 |
| 0488 07 | PIR ceiling switch movement sensor 360° angle motion detector | 14078 | 1/10 |
| 0488 17 | PIR 360° Corridor sensor 2x12m - IP41 - ceiling mounting | 15718 | 1/10 |
| 0488 04 | PIR high density 360° lighting sensor Ø8m - IP42 - ceiling mounting | 15994 | 1/10 |
| 0489 33 | PIR 270° lighting sensor 18m - IP55 - surface wall or ceiling mounting | 31394 | 1/10 |
| 0489 32 | PIR 360° lighting sensor Ø20m high bay - IP55 - Surface ceiling mounting | 26132 | 1/10 |
| 0489 53 | Miniature PIR ceiling-mounting Lighting Management DALI dimming sensor for 1 circuit - 360° | 21216 | 1/10 |
| 0489 54 | Miniature PIR ceiling-mounting Lighting Management ON/OFF presence sensor for 1 circuit - 360° | 18272 | 1/10 |
| 0489 59 | PIR IP40/IP65 ceiling-mounting Lighting Management sensor for 1 circuit - 360° for high bay applications - ON/OFF | 29290 | 1/10 |

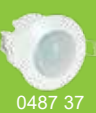

Movement Detectors

| Cat.Nos | Description | MRP* ₹ / Unit | Pack |
|---------|-------------|------------------|------|
|---------|-------------|------------------|------|

Movement Detectors for Lighting Control

| | | | |
|---------|--|-------|------|
| 0488 75 | Surface-mounting box for false ceiling sensors | 1104 | 1/10 |
| 0882 40 | Smart Bluetooth configuration gateway for multi-application configuration tool | 31532 | 1/10 |



Video Door Entry Systems

| Cat.Nos | Description | MRP* ₹ / Unit | Pack |
|---------|-------------|------------------|------|
|---------|-------------|------------------|------|

Door Entry Kits with Memory

| | | | |
|---------|--------------------------------------|-------|------|
| 3695 90 | Door entry kit 7" physical buttons | 15656 | 1/10 |
| 3695 91 | Door entry kit 7" capacitive buttons | 16158 | 1/10 |
| 3695 92 | Indoor unit 7" physical buttons | 10870 | 1/10 |
| 3695 93 | Indoor unit 7" capacitive buttons | 11550 | 1/10 |
| 3695 98 | Entrance panel for door entry kit 7" | 8230 | 1/20 |
| 3695 89 | Power adapter for door phone kit | 1092 | 1/50 |

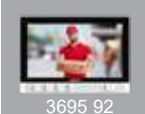
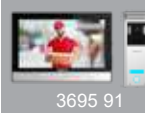

* MRP - Maximum Retail Price Inclusive of all taxes including GST.
Red Cat.Nos - new products

Bold Cat.Nos are products normally available with Legrand (India) Stockists. Cat.Nos that are not bold - delivery within 4 - 8 weeks from the date of order. Bold packing quantity is our mandatory packing. Orders to be placed by Legrand (India) Stockist in multiples of the same.



Video Door Entry System

IP System for the Best Performance

The ideal solution for large multiple-dwelling projects, able to guarantee high performance, long distances and high video signal quality.



Home + Security
The best App
for a safe home.



Scan to know more about
the product.



CLASSE 300EOS

The Smart Vision of the Home.

Classe 300EOS is the new 2 wires / Wi-Fi handsfree connected video internal unit with built-in Amazon Alexa voice assistant. Using the Home + Security App, in addition to video door entry calls, it is also possible to manage the devices of the Legrand connected security solutions, creating a simple and fast Smart security system.

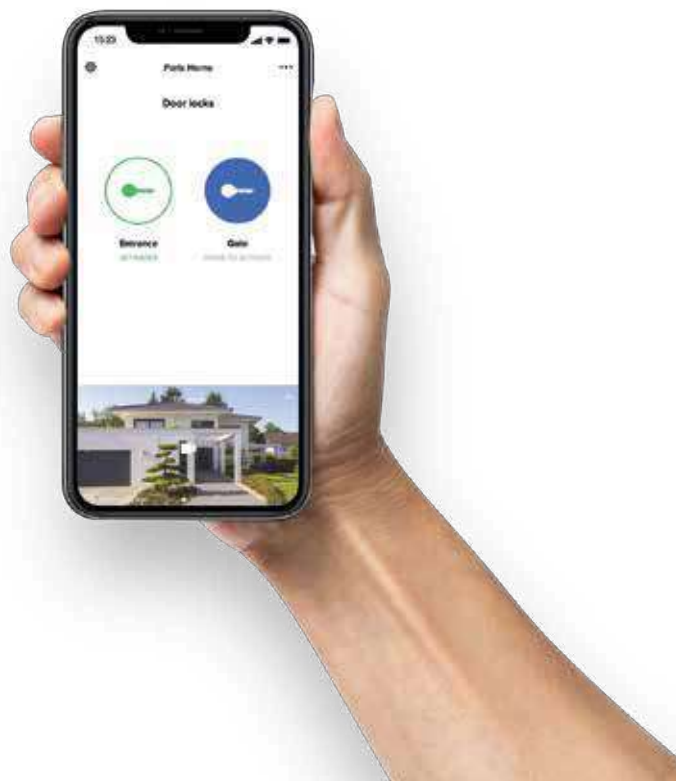

Scan to know more about
the product.

P17

TEMPRA PRO

Industrial Plugs & Sockets

Weatherproof Power Connectivity for Harsh Environments



P17 Tempra Pro is a high-performance range of industrial plugs and sockets designed for demanding environments. With multiple weatherproof ratings and robust construction, the system ensures reliable power connectivity for environments such as airports, data centers, hotels, and outdoor installations.

Features

- 16–125A range with IP44 to IP69 protection
- Rugged, weatherproof & chemical-resistant build
- Quick & easy installation design
- Flexible mounting & multiple configurations
- Ergonomic design with safety compliance (IEC standards)

Benefits

- Works reliably in any environment (indoor/outdoor)
- Higher safety & secure connections
- Saves installation time & effort
- Low maintenance & long-lasting performance
- Adaptable for all project needs & applications



Range

IP44



Straight plugs



Mobile sockets



Panel mounting sockets



Surface mounting sockets

IP66/67/69*



Straight plugs

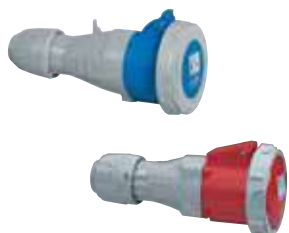

Mobile sockets



Panel mounting sockets



Surface mounting sockets



Scan to know more about the product.



P17 Tempra Pro IP 44 - LV 16 & 32A - Sockets & Plugs

| Cat.Nos | Description | MRP* ₹ / Unit | Pack |
|---------|-------------|------------------|------|
|---------|-------------|------------------|------|

Surface Mounting Sockets

| | | | |
|---------|----------------------------|------|----|
| 5551 54 | 200/250 V~, 16 A 2P+E | 971 | 10 |
| 5551 58 | 380/415 V~, 16 A 3P+E | 1197 | 10 |
| 5551 59 | 380/415 V~, 16 A 3P+N+E | 1268 | 10 |
| 5552 54 | 200/250 V~, 32 A 2P+E | 1213 | 5 |
| 5552 58 | 380/415 V~, 32 A 3P+E | 1518 | 10 |
| 5552 59 | 380/415 V~, 32 A 3P+N+E | 1610 | 10 |



5552 58

Panel Mounting Sockets Inclined Outlet

| | | | |
|---------|----------------------------|------|----|
| 5551 84 | 200/250 V~, 16 A 2P+E | 602 | 10 |
| 5551 88 | 380/415 V~, 16 A 3P+E | 885 | 10 |
| 5551 89 | 380/415 V~, 16 A 3P+N+E | 933 | 10 |
| 5552 84 | 200/250 V~, 32 A 2P+E | 926 | 10 |
| 5552 88 | 380/415 V~, 32 A 3P+E | 1170 | 10 |
| 5552 89 | 380/415 V~, 32 A 3P+N+E | 1240 | 10 |



5551 88

Mobile Sockets

| | | | |
|---------|----------------------------|------|----|
| 5551 04 | 200/250 V~, 16 A 2P+E | 784 | 10 |
| 5551 08 | 380/415 V~, 16 A 3P+E | 873 | 10 |
| 5551 09 | 380/415 V~, 16 A 3P+N+E | 926 | 10 |
| 5552 14 | 200/250 V~, 32 A 2P+E | 1040 | 10 |
| 5552 18 | 380/415 V~, 32 A 3P+E | 1249 | 10 |
| 5552 19 | 380/415 V~, 32 A 3P+N+E | 1320 | 10 |



5551 08

Straight Plugs

| | | | |
|---------|----------------------------|------|----|
| 5551 24 | 200/250 V~, 16 A 2P+E | 556 | 10 |
| 5551 28 | 380/415 V~, 16 A 3P+E | 682 | 10 |
| 5551 29 | 380/415 V~, 16 A 3P+N+E | 716 | 10 |
| 5552 34 | 200/250 V~, 32 A 2P+E | 837 | 10 |
| 5552 38 | 380/415 V~, 32 A 3P+E | 955 | 10 |
| 5552 39 | 380/415 V~, 32 A 3P+N+E | 1012 | 10 |



5551 28

P17 Tempra - Domestic Pin Configuration 16 A - 250 VA

Flush-Mounting Boxes

| | | | |
|---------|---|------|---|
| 0577 21 | For 2 panel mounting sockets With single fixing centres 70 x 70 mm - 16 A | 5499 | 3 |
| 0577 22 | For 1 panel mounting socket With single fixing centres 70 x 70 mm - 16 or 32 A (32 A to be fixed horizontally) | 3300 | 3 |



0577 22

* MRP - Maximum Retail Price Inclusive of all taxes including GST.

P17 Tempra Pro IP 66/67 LV 16 and 32 A

| Cat.Nos | Polarity | MRP* ₹ / Unit | Pack |
|---------|----------|------------------|------|
|---------|----------|------------------|------|

Surface Mounting Sockets

| | | | |
|---------|----------------------------|------|---|
| 5553 54 | 200/250 V~, 16 A 2P+E | 1623 | 5 |
| 5553 58 | 380/415 V~, 16 A 3P+E | 1806 | 5 |
| 5553 59 | 380/415 V~, 16 A 3P+N+E | 1965 | 5 |
| 5554 54 | 200/250 V~, 32 A 2P+E | 1924 | 5 |
| 5554 55 | 200/250 V~, 32 A 3P+E | 3324 | 5 |
| 5554 59 | 380/415 V~, 32 A 3P+N+E | 3602 | 5 |

Panel Mounting Sockets

| | | | |
|---------|----------------------------|------|---|
| 5553 84 | 200/250 V~, 16 A 2P+E | 1188 | 5 |
| 5553 88 | 380/415 V~, 16 A 3P+E | 1263 | 5 |
| 5553 89 | 380/415 V~, 16 A 3P+N+E | 1343 | 5 |
| 5554 84 | 200/250 V~, 32 A 2P+E | 1507 | 5 |
| 5554 88 | 380/415 V~, 32 A 3P+E | 1726 | 5 |
| 5554 89 | 380/415 V~, 32 A 3P+N+E | 1833 | 5 |

Mobile Sockets

| | | | |
|---------|----------------------------|------|---|
| 5553 04 | 200/250 V~, 16 A 2P+E | 1452 | 5 |
| 5553 08 | 380/415 V~, 16 A 3P+E | 1806 | 5 |
| 5553 09 | 380/415 V~, 16 A 3P+N+E | 1917 | 5 |
| 5554 14 | 200/250 V~, 32 A 2P+E | 1995 | 5 |
| 5554 18 | 380/415 V~, 32 A 3P+E | 2132 | 5 |
| 5554 19 | 380/415 V~, 32 A 3P+N+E | 2264 | 5 |

Straight Plugs

| | | | |
|---------|----------------------------|------|---|
| 5553 24 | 200/250 V~, 16 A 2P+E | 1263 | 5 |
| 5553 28 | 380/415 V~, 16 A 3P+E | 1386 | 5 |
| 5553 29 | 380/415 V~, 16 A 3P+N+E | 1473 | 5 |
| 5554 34 | 200/250 V~, 32 A 2P+E | 1710 | 5 |
| 5554 38 | 380/415 V~, 32 A 3P+E | 1797 | 5 |
| 5554 39 | 380/415 V~, 32 A 3P+N+E | 1906 | 5 |



5553 28

P17 Tempra Pro IP 66/67 LV 32 A for Refrigerated Containers

Combined Unit, Plug & Mobile Socket for Refrigerated Containers

| | | | |
|---------|--|-------|---|
| 6571 06 | Combined unit with interlocked switched socket - Double mechanical interlock - Cable glands are not supplied | 25411 | 1 |
|---------|--|-------|---|



6571 06

Bold Cat.Nos are products normally available with Legrand (India) Stockists. Cat.Nos that are not bold - delivery within 4 - 8 weeks from the date of order. Bold packing quantity is our mandatory packing. Orders to be placed by Legrand (India) Stockist in multiples of the same.

P17 Tempra Pro IP 66/67 LV 32 A for refrigerated containers

| Cat.Nos | Polarity | MRP* ₹ / Unit | Pack |
|---------|----------|------------------|------|
|---------|----------|------------------|------|

Combined Unit, Plug & Mobile Socket for Refrigerated Containers

| | | | |
|---------|--|------|---|
| 5554 41 | Straight plug With cable grip Ø12 to 21.5 mm | 2066 | 5 |
|---------|--|------|---|

P17 Tempra Pro IP 66/67 - LV 63 and 125 A

Surface Mounting Sockets

| | | | |
|---------|-----------------------------|-------|---|
| 5555 54 | 200/250 V~, 63 A 2P+E | 6710 | 2 |
| 5555 58 | 380/415 V~, 63 A 3P+E | 7013 | 2 |
| 5555 59 | 380/415 V~, 63 A 3P+N+E | 7410 | 2 |
| 5556 58 | 380/415 V~, 125 A 3P+E | 19446 | 2 |
| 5556 59 | 380/415 V~, 125 A 3P+N+E | 20611 | 2 |



5555 59

Panel Mounting Sockets

| | | | |
|---------|-----------------------------|-------|---|
| 5555 84 | 200/250 V~, 63 A 2P+E | 5324 | 2 |
| 5555 88 | 380/415 V~, 63 A 3P+E | 5429 | 2 |
| 5555 89 | 380/415 V~, 63 A 3P+N+E | 5718 | 2 |
| 5556 88 | 380/415 V~, 125 A 3P+E | 15367 | 1 |
| 5556 89 | 380/415 V~, 125 A 3P+N+E | 16432 | 1 |



5555 89

Straight Plugs

| | | | |
|---------|-----------------------------|-------|---|
| 5555 24 | 200/250 V~, 63 A 2P+E | 4508 | 2 |
| 5555 28 | 380/415 V~, 63 A 3P+E | 4678 | 2 |
| 5555 29 | 380/415 V~, 63 A 3P+N+E | 5021 | 2 |
| 5556 28 | 380/415 V~, 125 A 3P+E | 13634 | 1 |
| 5556 29 | 380/415 V~, 125 A 3P+N+E | 14448 | 1 |



5555 29

Mobile Sockets

| | | | |
|---------|-----------------------------|-------|---|
| 5555 04 | 200/250 V~, 63 A 2P+E | 5755 | 2 |
| 5555 08 | 380/415 V~, 63 A 3P+E | 5974 | 2 |
| 5555 09 | 380/415 V~, 63 A 3P+N+E | 6341 | 2 |
| 5556 08 | 380/415 V~, 125 A 3P+E | 19845 | 1 |
| 5556 09 | 380/415 V~, 125 A 3P+N+E | 21033 | 1 |



5555 09

Plugs & Sockets

| Cat.Nos | Polarity | MRP* ₹ / Unit | Pack |
|---------|----------|------------------|------|
|---------|----------|------------------|------|

P17 Combined Unit to be Equipped Bases with Mechanical Super-Compact Sockets

| | | | |
|---------|---|------|---|
| 0573 00 | 16 A, 2P+E IP 44 Interlock | 6719 | 1 |
| 0573 02 | 16 A, 3P+N+E IP 44 Interlock | 7415 | 1 |
| 0573 20 | 16 A, 2P+E IP 55 Interlock | 7537 | 1 |
| 0573 22 | 16 A, 3P+N+E IP 55 Interlock | 8482 | 1 |
| 0577 23 | Mounting plate for 2 super-compact mechanical interlock sockets | 3774 | 1 |



0573 00

Bases for 125 x 220 mm face plates

Example of combined unit configuration

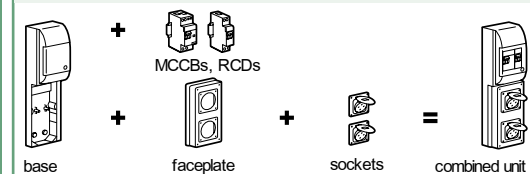

| | | | |
|---------|--|-------|---|
| 0577 10 | Surface mounting box - upto 2 sockets | 1571 | 2 |
| 0589 38 | Surface mounting box with 5 module dinrail - upto 2 sockets | 4391 | 1 |
| 0577 05 | Surface mounting box with 12 module dinrail - upto 4 sockets | 9702 | 1 |
| 0577 06 | Surface mounting box with 18 module dinrail - upto 6 sockets | 13580 | 1 |



0577 10



0577 05

Face Plates 125 x 220 mm without Sockets

| | | | |
|---------|------------------------------------|------|---|
| 0577 12 | For 1 x 16 A or 32 - upto A socket | 1489 | 5 |
| 0577 13 | For 2 x 16 A - upto sockets | 1871 | 5 |
| 0577 17 | For 1 x 63 A - upto sockets | 1718 | 5 |
| 0577 15 | Blanking Plate | 1263 | 5 |



Bases for 125 x 280 mm Face Plates

| | | | |
|---------|--|-------|---|
| 0577 11 | Surface mounting box - upto 3 sockets | 1636 | 3 |
| 0577 20 | Surface mounting box with 5 module dinrail - upto 3 sockets | 4712 | 1 |
| 0577 03 | Surface mounting box with 12 module dinrail - upto 6 sockets | 10057 | 1 |
| 0577 04 | Surface mounting box with 18 module dinrail - upto 9 sockets | 13989 | 1 |



0577 11



0577 04

* MRP - Maximum Retail Price Inclusive of all taxes including GST.

Bold Cat.Nos are products normally available with Legrand (India) Stockists. Cat.Nos that are not bold - delivery within 4 - 8 weeks from the date of order. Bold packing quantity is our mandatory packing. Orders to be placed by Legrand (India) Stockist in multiples of the same.

Plugs and Sockets

| Cat.Nos | Polarity | MRP* ₹ / Unit | Pack |
|---------|----------|------------------|------|
|---------|----------|------------------|------|

Face plates 125 x 280 mm without sockets

| | | | |
|---------|--|------|---|
| 0577 18 | For 2 x 16 A and / or 32 A sockets | 2339 | 4 |
| 0577 19 | For 1 x 16 A or 32 A socket and 1 x 63 A socket | 2199 | 2 |
| 0577 14 | For 3 x 16 A sockets | 2665 | 4 |
| 0577 16 | Blanking plate | 1485 | 4 |

Hypra Industrial Plugs & Sockets

Sockets

Prisinter Panel Mounting Sockets - IP 44, IK 09

| | | | |
|---------|---------------------|-------|------|
| 0520 02 | 230 V, 16 A, 2P+E | 13680 | 1/10 |
| 0527 02 | 230 V, 32 A, 2P+E | 14916 | 1/6 |
| 0529 03 | 415 V, 32 A, 3P+E | 15217 | 1/6 |
| 0529 04 | 415 V, 32 A, 3P+N+E | 18078 | 1/6 |
| 0536 04 | 415 V, 63 A, 3P+N+E | 58211 | 1 |

Panel Mounting Sockets - Inclined IP 44, IK 09

| | | | |
|---------|-------------------|------|------|
| 0522 23 | 415 V, 16 A, 3P+E | 2213 | 5/50 |
| 0538 23 | 415 V, 63 A, 3P+E | 7327 | 1 |

Plugs

Straight Plugs - IP 44, IK 09

| | | | |
|---------|---------------------|-------|------|
| 0520 42 | 250 V, 16 A, 2P+E | 2402 | 5/50 |
| 0527 42 | 250 V, 32 A, 2P+E | 2965 | 1/5 |
| 0522 43 | 415 V, 16 A, 3P+E | 3955 | 5/50 |
| 0529 43 | 415 V, 32 A, 3P+E | 3969 | 5/50 |
| 0529 44 | 415 V, 32 A, 3P+N+E | 4391 | 5/15 |
| 0538 43 | 415 V, 63 A, 3P+E | 10484 | 1/5 |
| 0538 44 | 415 V, 63 A, 3P+N+E | 14087 | 1/5 |

Metra Plugs & Sockets

Plugs

Ivory

| | | | |
|---------|-------------------|-----|---------|
| 6500 22 | 240 V, 10 A, 2P+E | 260 | 1/5/100 |
| 6500 28 | 240 V, 20 A, 2P+E | 273 | 1/5/100 |

Grey

| | | | |
|---------|-------------------|-----|---------|
| 6500 02 | 240 V, 10 A, 2P+E | 260 | 1/5/100 |
| 6500 08 | 240 V, 20 A, 2P+E | 273 | 1/5/100 |
| 6500 10 | 440 V, 20 A, 3P+E | 364 | 1/5/100 |
| 6500 16 | 440 V, 32 A, 3P+E | 685 | 1/5/100 |

Sockets

| | | | |
|---------|-------------------------------------|-----|---------|
| 6500 03 | 240 V, 10 A, 2P+E With blue cap | 264 | 1/5/100 |
| 6500 23 | 240 V, 10 A, 2P+E With ivory cap | 264 | 1/5/100 |

* MRP - Maximum Retail Price Inclusive of all taxes including GST.

Hypra Industrial Plugs and Sockets

| Cat.Nos | Description | MRP* ₹ / Unit | Pack |
|---------|-------------|------------------|------|
|---------|-------------|------------------|------|

Sockets

| | | | |
|---------|-------------------------------------|-----|---------|
| 6500 09 | 240 V, 20 A, 2P+E With blue cap | 303 | 1/5/100 |
| 6500 29 | 240 V, 20 A, 2P+E With ivory cap | 303 | 1/5/100 |
| 6500 11 | 440 V, 20 A, 3P+E With red cap | 407 | 1/5/100 |
| 6500 17 | 440 V, 32 A, 3P+E With red cap | 685 | 1/5/100 |

Plugs and Sockets

P17 Tempra Combined Units

With Interlocked Switched Sockets & Surface Mounting Box IP 44

| | | | |
|---------|---------------------|-------|---|
| 0566 01 | 250 V, 16 A, 2P+E | 10091 | 1 |
| 0566 09 | 250 V, 32 A, 2P+E | 12039 | 1 |
| 0566 13 | 415 V, 32 A, 3P+E | 14559 | 1 |
| 0566 14 | 415 V, 32 A, 3P+N+E | 15287 | 1 |

With Interlocked Switched Sockets and Surface Mounting Box IP 55

| | | | |
|---------|---------------------|-------|---|
| 0566 21 | 250 V, 16A, 2P+E | 11210 | 1 |
| 0566 29 | 250 V, 32 A, 2P+E | 12805 | 1 |
| 0566 33 | 415 V, 32 A, 3P+E | 16231 | 1 |
| 0566 34 | 415 V, 32 A, 3P+N+E | 16527 | 1 |

With Interlocked Switched Sockets and Surface Mounting Box IP 44 with DIN Rail for 5 Module DX³ Protection

| | | | |
|---------|---------------------|-------|---|
| 0566 41 | 250 V, 16A, 2P+E | 10764 | 1 |
| 0566 49 | 250 V, 32 A, 2P+E | 13094 | 1 |
| 0566 53 | 415 V, 32 A, 3P+E | 14478 | 1 |
| 0566 54 | 415 V, 32 A, 3P+N+E | 15492 | 1 |

With interlocked Switched Sockets & Surface Mounting Box IP 66 with DIN Rail for 5 Module DX³ Protection

| | | | |
|---------|---------------------|-------|---|
| 0566 61 | 250 V, 16 A, 2P+E | 12059 | 1 |
| 0566 69 | 250 V, 32 A, 2P+E | 13992 | 1 |
| 0566 73 | 415 V, 32 A, 3P+E | 15106 | 1 |
| 0566 74 | 415 V, 32 A, 3P+N+E | 16331 | 1 |

With Interlocked Switched Sockets & Without Surface Mounting Box IP 55

| | | | |
|---------|----------------------------|-------|---|
| 0572 21 | 250 V, 16 A, 2P+E | 9702 | 1 |
| 0572 29 | 250 V, 32 A, 2P+E | 10970 | 1 |
| 0572 33 | 415 V, 32 A, 3P+E | 13024 | 1 |
| 0572 34 | 415 V, 32 A, 3P+N+E | 14227 | 1 |
| 0572 95 | 415 V, 63 A, 3P+N+E, IP 66 | 31046 | 1 |

P17 tempra Combined Units

with Interlocked Switched Sockets IP 66

| | | | |
|---------|---|-------|---|
| 0589 18 | 380 to 415 V, 50/60 Hz, 63 A, 3P + E with provision for 5 module DX ³ protection | 33064 | 1 |
| 0572 99 | 380 to 415 V, 50/60 Hz, 63 A, 3P+N+E with provision for 5 module DX ³ protection | 37256 | 1 |

Bold Cat.Nos are products normally available with Legrand (India) Stockists. Cat.Nos that are not bold - delivery within 4 - 8 weeks from the date of order. Bold packing quantity is our mandatory packing. Orders to be placed by Legrand (India) Stockist in multiples of the same.

Warranty policy

Legrand warrants to the original purchaser that the Products (excluding any third party products purchased through Legrand, for which no warranties are made) will be free from defects in material and workmanship, under normal use and regular service, and preventative maintenance for a period of 18 months from the date of shipment or 12 months from the date of installation whichever is earlier. Should any failure to conform with this warranty be found during the Warranty Period, you must notify Legrand of your claim within thirty (30) days of discovery, and within the Warranty Period. Your failure to give notice of claims of breach of warranty within the Warranty Period shall be deemed an absolute and unconditional waiver of claims for such defects. Legrand will have no responsibility to honour claims received after the date the applicable Warranty Period expires. The invoice / bill in original must be produced without which warranty claim shall not be entertained.

This warranty does not cover the following:

- Defect caused due to misuse, alteration, faulty installation, faulty electrical systems, negligent maintenance or misapplication of the product.
- Failure of product or components due to any act of nature; lightning strike, floods, hurricanes, tornadoes, etc. beyond the control of human being.
- Legrand does not warrant any third party products or associated hardware or their performance or suitability for use and application. Such items are provided “as-is”.

Extended warranty policy is applicable for following products,

1. DX³ & RX³ MCB – 5 years if mounted inside Legrand DB
2. Arteor™ Advance, Arteor™, Myrius™, Myrius™ Regular, Mylinc™, Lyncus™, Allzy™, Britzy™ switches (without neon lamp) & Power sockets – 10 years
3. Arteor™ Advance, Arteor™, Myrius™, Myrius™ Regular, Mylinc™, Lyncus™, Allzy™, Britzy™ other products – 2 years
4. Arteor™ Advance IoT, Arteor IoT & Myrius™ IoT - 2 years

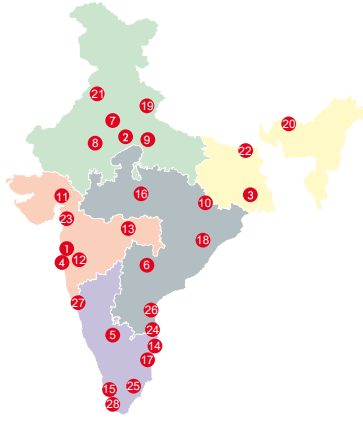

Head offices

- 61 & 62, 6th Floor,
Kalpataru Square, Kondivita Road,
Off Andheri-Kurla Road, Andheri (E),
MUMBAI – 400 059.
Tel.: (022) 3041 6200
Fax : (022) 3041 6201
Website : www.legrand.co.in

Regional sales offices

- B-225, 4th Floor, Okhla Industrial Area, Phase -1,
NEW DELHI – 110020.
Tel.: (011) 3990 2200 **INNOVAL**
- Ecocenter Ambuja Neotia,
Block - EM-04, 12th Floor,
Unit - 1203, Sector - V, Salt Lake,
KOLKATA – 700 091.
Tel.: (033) 4021 3535 / 3536 **INNOVAL**
- C/203, Corporate Avenue, Atul Projects,
Near Mirador Hotel, Chakala,
Andheri - Ghatkopar Link Road,
Andheri - (E), **MUMBAI** – 400 099.
Tel.: (022) 6230 1000 **INNOVAL**
- Ferozes Manor, 1st Floor, No. 58,
Bowring Hospital Road,
BANGALORE – 560 001.
Tel.: (080) 80682 20000 **INNOVAL**
- Prestige Phoenix, 1st Floor,
Survey number 199,
Door No. 6-3-1219/J/101 & 102,
Begumpet, **HYDERABAD**,
Telangana - 500 016
Tel.: (040) 4567 1717/2341 4398/234 14367 **INNOVAL**

Branch offices

- Bestech Business Tower
Unit no. 203, 2nd floor
Tower -B, Sector -66,
MOHALI- 160 062
Tel.: (0172) 5019 008/ 4635 145 **INNOVAL**
- 128, Mohan Nagar besides
Ridhi Siddhi Flyover, **JAIPUR** - 302019
Tel.: 0141-220 8665 **INNOVAL**
- 209-A, 2nd Floor, Cyber Heights,
Opp. Indira Gandhi Pratishthan,
Vibhuti Khand, Gomti Nagar,
LUCKNOW – 226 010.
Tel.: (0522) 457 5427 **INNOVAL**
- 202 & 203, Sunrise, Forum 100,
Burdwan Compound, Lalpur,
RANCHI - 834 001.
Tel.: (651) 660 5400
- A 101-102, Mondeal Heights,
Besides Novotel Hotel, Sarkhej
Gandhinagar Highway (S G Highway),
AHMEDABAD – 380 015.
Tel.: (079) 6134 0555 **INNOVAL**
- 8th Floor, Pinnacle Park Avenue,
Opp. Law College, Law College Road
Next To German Bakery,
Shivaji Nagar, **PUNE** - 411004.
Tel.: (020) 6729 5601 / 600 **INNOVAL**
- Plot No.95, 2nd Floor, Shreyash
Heights, VIP Road, Ramdaspath,
NAGPUR – 440 010.
Tel.: (0712) 2440 900
- 10 B, Prestige Center Court, Office Block,
Vijaya Forum Mall, #183,N.S.K. Salai,
Vadapalani, **CHENNAI** – 600 026.
Tel.: (044) 6612 2800 **INNOVAL**
- J. B. Manjooran Estate,
Door No. 37/3484, 3rd Floor,
Bye Pass Junction, Edappally,
COCHIN – 682 024.
Tel.: (0484) 2801921/6604700 **INNOVAL**
- 204-205, Megapolis Square,
579, M G Road,
INDORE – 452 001.
Tel.: (0731) 49998 91/92/93
- MF-2, Datta's Lords House,
Jammi Chettu Street, Mogalrajapuram,
VIJAYAWADA – 520 010.
Tel.: (0866) 2482393/6393

- Plot No. 359, Saheed Nagar,
2nd Floor,
BHUBANESWAR – 751 007.
Tel.: (0674) 2540 623
- Unit - 1 & 2, Vijay Park,
Main Chakrata Road,
DEHRADUN- 248 001.
Uttarakhand.
Tel.: (0135) 661 6100 **INNOVAL**
- House No. 97, Ground Floor,
Rajgarh Main Road,
Opp. City Heart Nursing Home,
GUWAHATI – 781 007.

Area offices

- SCO 50-51, 2nd Floor Lodhi Club
Road Shaheed Bhagat Singh
Nagar, **LUDHIANA** – 141 013.
Tel.: (0161) 463 8439 **INNOVAL**
- 94, Udhm Singh Sarani,
Ground Floor, Ashrampara,
SILIGURI – 734 001.
Tel.: (353) 264 1067
- A-207, Universal Business
Center, Near Madhwan Circle,
L.P. Savani Road, Adajan,
SURAT – 395 009.
Tel.: (0261) 263 3861 **INNOVAL**
- Aparna Towers, 1st Floor, 2/3,
Bypass Road,
MADURAI – 625 010.
Telefax : (0452) 230 8414
- 43-9-205, 3rd Floor, Plot No. 10,
Subbalakshmi Nagar,
Opp. More Super Market,
VISAKHAPATNAM – 530 016.
Tel.: (0891) 273 5652/9363 **INNOVAL**
- B-5, 1st Floor, Thirumalai Towers,
723, Avanashi Road,
COIMBATORE – 641 018.
Tel.: (0422) 668 3200/222 3634 **INNOVAL**
- 515 & 516, Gera Imperium Grand,
Patto centre ,
Panaji **GOA** – 403 001 **INNOVAL**
- TC 25/3254/6, 1st Floor, Cordial Bharathi
Nanthancodu, **Thiruvanthapuram**,
KERALA- 695 003
Tel.: (0471) 354 5052/353 8935 **INNOVAL**
- 2nd Floor, GND Chambers,
Agrasen Chowk, Samta Colony,
Raipur - 492001, **Chattisgarh**
Tel.: (0771) 4052 400

Technical assistance from Legrand

Telephonic technical assistance for selection of products, technical information, guidance, wiring diagrams and estimation is now made available to you at each Regional Office. Contact the Technical Officer of Legrand at the following telephone numbers

- New Delhi** : Tel.: (011) 3990 2200
Kolkata : Tel.: (033) 4021 3535
Mumbai : Tel.: (022) 6230 1000
Chennai : Tel.: (044) 6612 2800
Hyderabad : Tel.: (040) 4567 1717

For other places, contact the nearest
Regional / Branch / Area offices

customer.care@legrand.co.in

